



# H. J. THIM TRUST'S THEEM COLLEGE OF ENGINEERING

Approved by AICTE (New Delhi), Government of Maharashtra & DTE, Affiliated to University of Mumbai & MSBTE, Estd. 2009  
NAAC Accredited with B+ Grade

Village Betagaon, Boisar Chilhar Road, Boisar (E), Tal. & Dist.: Palghar - 401 501.

Tel.: (02525) 284 909 • Fax : (02525) 284 927 • Email : info@theemcoe.org • Website : www.theemcoe.org

## **Circular and Brochure of various Activities**

# A.Y.

# 2022-23



# H. J. THIM TRUST'S THEEM COLLEGE OF ENGINEERING

Approved by AICTE (New Delhi), Government of Maharashtra & DTE, Affiliated to University of Mumbai & MSBTE, Estd. 2009  
NAAC Accredited with B+ Grade

Village Betagaon, Boisar Chilhar Road, Boisar (E), Tal. & Dist.: Palghar - 401 501.

Tel.: (02525) 284 909 • Fax : (02525) 284 927 • Email : info@theemcoe.org • Website : www.theemcoe.org

## Year 5 A.Y 2022-23

Date of event/activity (DD-MM-YYYY)	Name of the event/activity	Name of the organising institution	Name of the student participated
<b>SPORTS (Jashn -E- Theem)</b>			
9/3/2023	Running 100m (Boys)	TCOE	Vrushant, Viraj, Harish
9/3/2023	Running 100m (Girls)	TCOE	Muskan, Tanisha, Mahek
9/3/2023	Running 200m (Boys)	TCOE	Sohail, Tanmay, Harish
9/3/2023	Relay (4*100)	TCOE	viraj, tejas, ruthi, Himanshu
9/3/2023	Long Jumps (Boys)	TCOE	Sajan, Tejas, Viraj
9/3/2023	Long Jumps (Girls)	TCOE	Mahek, Zoha, Alisha
9/3/2023	Discuss Throw (Boys)	TCOE	Daniyal, Rizwan, Swapnil
9/3/2023	Discuss Throw (Girls)	TCOE	Zoha, Alisha, Purva
9/3/2023	Shot Put (Boys)	TCOE	Mayur, Ritvik, Siddharth
9/3/2023	Shot Put (Girls)	TCOE	Alisha, Mitali, Mansavee
9/3/2023	Javelin (Boys)	TCOE	Rizwan, Danish, Daniyal
9/3/2023	Javelin (Girls)	TCOE	Mansi, Alisha, Halima
9/3/2023-14/3/2023	Carrom Singles (Boys)	TCOE	Menaz, Asif
9/3/2023-14/3/2023	Carrom Singles (Girls)	TCOE	Jannat, Nandeeta
9/3/2023-14/3/2023	Carrom Doubles (Boys)	TCOE	Asif, Chirag, Anish, Navish
9/3/2023-14/3/2023	Carrom Doubles (Girls)	TCOE	Jannat, Jagruti, Nandeeta
6/3/2023-10/3/2023	Chess (Boys)	TCOE	Pratik, Sheryas
6/3/2023-10/3/2023	Chess (Girls)	TCOE	Sakshi, Shruthi
6/3/2023-14/3/2023	Badminton Singles (Boys)	TCOE	Amey, Althmash, Nimish
6/3/2023-14/3/2023	Badminton Singles (Girls)	TCOE	Vini, Manasavee, Hitakshi
6/3/2023-14/3/2023	Badminton doubles (Boys)	TCOE	Amey, Sumit, Shrimat, kunal
6/3/2023-14/3/2023	Throwball (Girls)	TCOE	BE-COMPS, BE-IT, TE-COMPS, FE
6/3/2023-14/3/2023	Kabaddi (Boys)	TCOE	TY-ELECTRICAL, TE-AIML, TE-MECH
6/3/2023-14/3/2023	Kho-Kho (Boys)	TCOE	TY-ELECT, SY-COMPS, TY-MECH
6/3/2023-14/3/2023	Kho-Kho (Girls)	TCOE	FY-COMP, TE-COMP, FY-COMP
6/3/2023-14/3/2023	Volleyball (Boys)	TCOE	SE-AIML, TY-MECH, SE-MECH

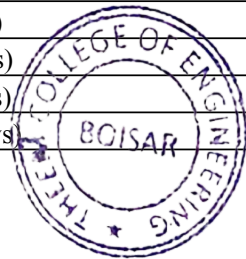

*[Signature]*  
**PRINCIPAL**  
THEEM COLLEGE OF ENGINEERING  
At. Village Betagaon, Boisar Chilhar Road,  
Boisar (East) Tal. & Dist. Palghar - 401 501



6/3/2023-14/3/2023	Football (Boys)	TCOE	FY,IT,TY-ELECT
15/3/2023	Tug of War (Boys)	TCOE	BE-IT,BE-COMP
15/3/2023	Tug of War (Girls)	TCOE	BE-IT,FY-COMP
6/3/2023-14/3/2023	Box Cricket (Boys)	TCOE	BE-CIVIL,BE-ELECT
6/3/2023-14/3/2023	Cricket (Girls)	TCOE	JR.COLLEGE,IT-A
04/3/2023-13/3/2023	Open Cricket (Boys)	TCOE	BE-CIVIL,FY-COMPS
14/3/2023	Open Cricket (Boys) (INTER)	TCOE	SDSM-PALGHAR,TCOE-DEGREE
14/3/2023	Volleyball (Boys) (INTER)	TCOE	SFIT-BORIVALI,SJCEM-PALGHAR
<b>Cultural (Jashn -E- Theem)</b>			
6/3/2023-14/3/2023	FETE	TCOE	Sanj Patil, Neha Sankhe, Ritesh Dhodi
6/3/2023	Mismatch Day (Jr.College)	TCOE	Muskan Chablu, Saniya Shaikh
6/3/2023	Mismatch Day (Girls)	TCOE	Priya Jha, Trupti Bhoir
6/3/2023	Mismatch Day (Boys)	TCOE	Ritik Khandare, Haider Bagasarwala
8/3/2023	Group Day	TCOE	Tejas Patil, Vedant Raut, Dhruv Sankhe
9/3/2023	Bollywood Day (Boys)	TCOE	Faizan Qurseshi, Naveed, Sarvesh
9/3/2023	Bollywood Day (Girls)	TCOE	Monika Bhoys, Anjali Purohit
10/3/2023	Traditional Day (Girls)	TCOE	Shraddah Deshmukh, Purva Chaudhary
10/3/2023	Traditional Day (Boys)	TCOE	Deepam Raut, Dhruv Raut
13/3/2023	Cook without fire (Boys)	TCOE	Jiten Das, Yashesh Patel
13/3/2023	Cook without fire (Girls)	TCOE	Mahek Shaikh, Fardeen Ansari
16/3/2023	Dance (Solo)	TCOE	Sai Aparna, Yash Prakash
16/3/2023	Dance (Duet)	TCOE	Aasiya Shaikh, Aniket More
16/3/2023	Dance (Group)	TCOE	Shrisha Shetty, Manasvee Doiphode



  
**PRINCIPAL**  
 THEEM COLLEGE OF ENGINEERING  
 At. Village Betegaon, Boisar Chithar Road  
 Boisar (East) Tal. & Dist. Palghar - 401 501



H. J. THIM TRUST'S

## THEEM COLLEGE OF ENGINEERING

### NOTICE

Date: 01/03/2023

All the students are hereby informed that, the college level Athletics (Boys and Girls) events will be starting from 9<sup>th</sup> March 2023. All the interested students should enroll your name as an Individual or Group on or before 3<sup>rd</sup> March 2023.

(Entry fees for Individual are Rs 10 and for Group /Team is Rs 40.)

Following Coordinators:-

ASIF (TE IT)

DANISH (SE AIML)

ANISH (TE COMP)

RITVIK(TE AIML)

#### Staff Coordinator

Prof. N G Hiremath

Prof. Harshad R.

Mr. Neetishkumar

Mrs. Sayali Patil

Mrs. Surekha Attarde

#### Sport Coordinator

Prof. Harshal Ahire

Prof. Ayaz Bagwan.



  
- PRINCIPAL  
THEEM COLLEGE OF ENGINEERING  
At Village Betegaon, Bolsar Chikhar Road,  
Bolzar (East) Tal. & Dist. Palghar - 401 501

# JASHN-E-THEEM 2023

# ATHLETICS DAY

## 9th MAR 2023



*[Signature]*  
PRINCIPAL  
THEEM COLLEGE OF ENGINEERING  
AL Village Belegaon, Bolisar Chikhar Road,  
Bolisar (Erat) Tal. & Dist. Palghar - 401 501

**Student Coordinators**

**Asif (TE IT)**

**Anish (TE COMP)**

**Danish (SE AIML)**

**Ritvik (TE AIML)**

**Staff Coordinators**

**Prof N G Hiremath (8880106375)**

**Prof Harshad R**



*[Signature]*  
PRINCIPAL  
THEEM COLLEGE OF ENGINEERING  
AL Village Belegaon, Bolisar Chikhar Road,  
Bolisar (Erat) Tal. & Dist. Palghar - 401 501



H. J. THIM TRUST'S  
**THEEM COLLEGE OF ENGINEERING**

Bolsar Chikhar Road, Betegad, Bolar (E), Tal. & Dist. Palghar - 401 501. • Tel: +917769914109 • Website: www.theemcoe.org

**REPORT OF JASHN-E-THEEM 2023 (ATHLON 23)**

Athletic (Intra)  
 9/03/2023



Sr. No.	Event's Name	School/College Name	Number of Candidate	Result	Co-ordinator's Name (Staff & Student)	Photos (Y/N)	Remark
1)	Running 100m (Boys)		22		Prof. N.G. Hiramath	Yes	
		Vrushant Dhanpal	TY Elect	Winner	Prof. Ashfaq Ahmed		
		Viraj Sankhe	SY Elect	1 <sup>st</sup> Runner up	Mr. Neeshkumar		
		Harish Shaikh	BE Comp	2 <sup>nd</sup> Runner up	Mrs. Attarde.		
2)	Running 100m (Girls)		10		Darpan Patil (TECH)		
		Mulkan Chabinal	11 <sup>th</sup> Sci	Winner	Vaibhav Pandey		
		Tanisha Raut	TE Comp	1 <sup>st</sup> Runner up	Ankita Gupta (TEIT)		
		Mahek Shaikh	BE Comp	2 <sup>nd</sup> Runner up			
3)	Running 200m (Boys)		16				
		Sohil Bari	BE Mech	Winner			
		Tanmay Pimple	TE Mech	1 <sup>st</sup> Runner up			
		Harish Shaikh	BE Comp	2 <sup>nd</sup> Runner up			

Judges : \_\_\_\_\_

Chief Guest : \_\_\_\_\_

*Harshad*  
 Chief Co-ordinator  
 (Name & Signature)  
 Prof. Harshad A. A. A.



*[Signature]*  
 PRINCIPAL  
 THEEM COLLEGE OF ENGINEERING  
 At Village Betegad, Bolsar Chikhar Road,  
 Bolsar (East) Tal. & Dist. Palghar - 401 501





H. J. THIM TRUST'S  
**THEEM COLLEGE OF ENGINEERING**

Bosar Chikhar Road, Betegad, Bolsar (E), Tal. & Dist. Palghar - 401 501. • Tel: +91 77 69916329 • Website: www.theemcoe.org

**REPORT OF JASHN-E-THEEM 2023 (ATHLON 23)**

Athletics (Intra)  
08/03/23



Sr. No.	Event's Name	School/College Name	Number of Candidate	Result	Co-ordinator's Name (Staff & Student)	Photos (Y/N)	Remark
4)	Relay (4X100) (Boys)		6x4=24		Prof. N.G. Hiramath	Yes	
		Viraj Sankhe	SY Elect	winner	Prof. Ashfaq Ahmed		
		Tejas Patil	SE Auto	-	Mr. Neelish Kumar		
		Rufi Fakri	BE Comp	-	Mrs. Attarde		
		Sohil Bari	BE Mech	-			
		Himanshu Patil	TY Elect	1 <sup>st</sup> runner up	Darpan Patil (Tech)		
		Amey Sare	TY Elect	-	Vaibhav Bady C		
		Aryan Patil	TE Comp	-	Ankita Gupta (Tech)		
		Nimesh Patil	TY Elect	-			
		Ved Purandare	TY Elect	2 <sup>nd</sup> runner up			
		Prem Yadav	SE Comp	-			
		Rohit Chouhan	SY Elect	-			
		Atharva Angre	TY Mech	-			

Judges :

Chief Guest :

  
Chief Co-ordinator  
(Name & Signature)



  
PRINCIPAL  
THEEM COLLEGE OF ENGINEERING  
At Village Betegad, Bolsar Chikhar Road,  
Bolzar (East) Tal. & Dist. Palghar - 401 501







H. J. THIM TRUST'S  
**THEEM COLLEGE OF ENGINEERING**

Bolsar Chikhar Road, Betegad, Bolsar (E) Tal. & Dist.: Palghar - 401 501. • Tel.: +917759015100 • Website: www.theemcoe.org

**REPORT OF JASHN-E-THEEM 2023 (ATHLON 23)**

Athletic (Intra)  
09/03/23



Sr. No.	Event's Name	School/College Name	Number of Candidate	Result	Co-ordinator's Name (Staff & Student)	Photos (Y/N)	Remark
6	Discus Throw (Boys)		<u>13</u>				
		Daroyal Damanwala	TYMech	winner	Pat. N.G. Hiramath	Yes	
		Rizwan Khan	BEIT	2 <sup>nd</sup> runner	Pat. Ashfaq Ahmed		
		Shoeb Khan	BEcomp	2 <sup>nd</sup> runner	Mr. Neelish Kumar		
					Mrs. Atarde		
7	Discus Throw (Girls)		<u>17</u>				
		Zoha Shaikh	TE comp	winner	Darpan Patil		
		Alisha Shaikh	BE comp	2 <sup>nd</sup> runner	Vaibhaw Pandey		
		Purva Chaudhari	TE CIVIL	2 <sup>nd</sup> runner	Ankita Gupta		

Judges : \_\_\_\_\_  
Chief Guest : \_\_\_\_\_

*Hemal*  
Chief Co-ordinator  
(Name & Signature)



*[Signature]*  
PRINCIPAL  
THEEM COLLEGE OF ENGINEERING  
At Village Betegad, Bolsar Chikhar Road,  
Bolsar (East) Tal. & Dist. Palghar - 401 501



H. J. THIM TRUST'S  
**THEEM COLLEGE OF ENGINEERING**  
 Bolar Chikar Road, Betegach, Bolser (E), Tal. & Dist. Palghar - 401 501. • Tel: +917769916006 • Website: www.theemcon.org  
**REPORT OF JASHN-E-THEEM 2023 (ATHLON 23)**

Athletics (Zebra)  
 09/03/23



Sr. No.	Event's Name	School/College Name	Number of Candidate	Result	Co-ordinator's Name (Staff & Student)	Photos (Y/N)	Remark
8)	Shot put (Boys)		<u>17</u>		Prof. N.G. Hiramath	yes	
		Mayur Dhodi	TE CIVIL	Winner	Prof. Ashfaq Ahmed		
		Ritvik Potjari	SY ELET	1 <sup>st</sup> runner	Mr. Neelesh Kumar		
		Siddharth Tamore	TE MECH	2 <sup>nd</sup> runner	Mrs. Attarde		
9)	Shot put (Girls)		<u>14</u>		Darpan Patil		
		Alisha Shaikh	BE COMP	Winner	Vaibhav Bodey		
		Mitali Mhatre	TE IT	1 <sup>st</sup> runner	Antita Gupta		
		Manasvee Doiphode	BE EXT	2 <sup>nd</sup> runner			

Judges :

Chief Guest :

*Manish*  
 Chief Co-ordinator  
 (Name & Signature)



*[Signature]*  
 PRINCIPAL  
 THEEM COLLEGE OF ENGINEERING  
 At Village Betegach, Bolser Chikhar Road,  
 Bolser (E) Tal. & Dist. Palghar - 401 501



H. J. THIM TRUST'S  
**THEEM COLLEGE OF ENGINEERING**

Bolsar Chikhar Road, Betegwar, Bolsar (E), Tal. & Dist.: Palghar - 401 501. • Tel.: +917709916009 • Website: www.theemcoe.org

**REPORT OF JASHN-E-THEEM 2023 (ATHLON 23)**

Athletics (Intro)  
 03/03/23



Sr. No.	Event's Name	School/College Name	Number of Candidate	Result	Co-ordinator's Name (Staff & Student)	Photos (Y/N)	Remark
10)	Javelin (Boys)		20				
		Rizwan Khan	BE IT	Winner	Prof. N.G. Hiremath	Yes	
		Danish Khan	TY mech	1 <sup>st</sup> runner	Prof. Ashfaq. Ahmed		
		Daniyal Damanwala	TY mech	2 <sup>nd</sup> runner	Mr. Neelishkumar		
11)	Javelin (Girls)		17				
		Mansi Samir	TE AIML	Winner	Deepen Patil		
		Alisha Shaikh	BE Comp	1 <sup>st</sup> runner	Vaibhaw Pandey		
		Halima Khan	sithsci	2 <sup>nd</sup> runner	Ankita Gupta		

Judges : \_\_\_\_\_  
 Chief Guest : \_\_\_\_\_

Harshad  
 Chief Co-ordinator  
 (Name & Signature)

*[Signature]*  
 PRINCIPAL



THEEM COLLEGE OF ENGINEERING  
 AL Village Betegwar, Bolsar Chikhar Road  
 Bolsar (East) Tal. & Dist. Palghar - 401 501





H. J. THIM TRUST'S  
**THEEM COLLEGE OF ENGINEERING**

Boisar Chikhar Road, Belagadri, Boisar (T) & Dist.: Palghar - 401 501 • Tel. +917709926109 • Website: www.theemcoe.org

**REPORT OF JASHN-E-THEEM 2023 (ATHLON 23)**

9<sup>th</sup> March to 14<sup>th</sup> March 2023  
 Carrom (Intra)



Sr. No.	Event's Name	School/College Name	Number of Candidate	Result	Co-ordinator's Name (Staff & Student)	Photos (Y/N)	Remark
12)	Carrom Singles (Boys)		71		Prof. Moinuddin Ansari	Yes	
		Menaz Shaikh	SEIT	winner			
		Aasif Shaikh	TECIVIL	1 <sup>st</sup> runner	Aasif Shaikh		
13)	Carrom Singles (Girls)		17		Adnan Khan		
		Jannat Shaikh	BE Comp	winner	Nandita Singh		
		Nandanta Kumbhar	BE Comp	1 <sup>st</sup> runner	Usmangani Patel		
14)	Carrom Doubles (Boys)		6x2=12		Fahim Shaikh		
		Aasif Shaikh	TECIVIL	winner			
		Chinay Patil	TECIVIL	1 <sup>st</sup> runner			
		Aarish Khan	SY Comp	1 <sup>st</sup> runner			
		Navin Chudasma	SE AIML	1 <sup>st</sup> runner			
15)	Carrom Doubles (Girls)		4x2=8				
		Jannat Shaikh, Japnati Patil	BE Comp	winner			
		Nandita Kumbhar, Manaji Ghant	BE Comp	1 <sup>st</sup> runner			

*[Signature]*

PRINCIPAL

THEEM COLLEGE OF ENGINEERING  
 AL Village Belagadri, Boisar Chikhar Road  
 Boisar (East) Tel. & Dist. Palghar - 401 501

Judges : \_\_\_\_\_  
 Chief Guest : \_\_\_\_\_

*[Signature]*  
 Chief Co-ordinator  
 (Name & Signature)





H. J. THIM TRUST'S  
**THEEM COLLEGE OF ENGINEERING**  
 Bolnar Chikhar Road, Belagach, Bolnar (E), Tal. & Dist. Palghar - 401 501. • Tel. +917709916109 • Website: www.theemcoe.org

**REPORT OF JASHN-E-THEEM 2023 (ATHLON 23)**

Chess (Intra)  
 6th March 23  
 to 10th March 23

Sr. No.	Event's Name	School/College Name	Number of Candidate	Result	Co-ordinator's Name (Staff & Student)	Photos (Y/N)	Remark
16)	chess (Boys)		<u>68</u>		Prof. Kazi Azimuddin		
		Pratik Machhi	SE Comp	Winner			
		Shreyas Jadhav	TE Comp	1 <sup>st</sup> runner			
17)	chess (Girls)		<u>03</u>		Sakshi Chavan Maaz Shaikh		
		Sakshi Chavan	SE Comp	Winner	Rahul Jaiswar		
		Sutiya Shaikh	TE AML	1 <sup>st</sup> runner			

Judges : \_\_\_\_\_

Chief Guest : \_\_\_\_\_

*Harshad*  
 Chief Co-ordinator  
 (Name & Signature)



*[Signature]*  
 PRINCIPAL  
 THEEM COLLEGE OF ENGINEERING  
 AL Village Belagach, Bolnar Chikhar Road  
 Bolnar (East) Tal. & Dist. Palghar - 401 501



H. J. THIM TRUST'S

## THEEM COLLEGE OF ENGINEERING

### NOTICE

Date: 01/03/2023

All the students are hereby informed that, the college level Badminton Singles and Doubles events will be starting from 06 Mar 2023. All the interested students should enroll your name as an Individual or Group on or before 03 Mar 2023.

(Entry fees for Individual are Rs 10 and for Group /Team is Rs 20.)

Following Students Coordinators:-

AMEY (SE IT)

NIMISH (SE IT)

ALTMASH (SE COMP)

SUMIT (TE IT)

#### Staff Coordinator

Prof. Abid Manyar

#### Sport Coordinator

Prof. Harshal Ahire

Prof. Ayaz Bagwan.



  
PRINCIPAL  
THEEM COLLEGE OF ENGINEER, PVT. LTD.  
At Village Betegad, Boisar Chikhar Road,  
Boisar (East) Tal. & Dist. Palghar - 401 507



# JASHN-E-THEEM 2023

## BADMINTON

### 6 MAR 2023



**Student Coordinators**

**Amey (SE IT)**

**Altmash (SE Comp)**

**Nimish (SE IT)**

**Sumit (TE IT)**

**Staff Coordinators**

**Prof Abid Manyar (8983189619)**



*Theem*  
PRINCIPAL  
THEEM COLLEGE OF ENGINEERING  
AL Village, Bobogada, Boisar, Chikkar, Kollam  
Boisar (East) Tal. & Dist. Palghat - 401 501



H. J. THIM TRUST'S  
**THEEM COLLEGE OF ENGINEERING**

Bosar Chikar Road, Betagad, Bosar (E), Tal. & Dist.: Palghar - 401 501. • Tel.: +917709916108 • Website: www.theemcoe.org

**REPORT OF JASHN-E-THEEM 2023 (ATHLON 23)**

Badminton (Intra)  
 6th march  
 to 14th march



Sr. No.	Event's Name	School/College Name	Number of Candidate	Result	Co-ordinator's Name (Staff & Student)	Photos (Y/N)	Remark
18)	Badminton Singles (Boys)		<u>48</u>		Prof. Abid Manyar		
		Ameey Save	TYElect	Winner	Mr. Ketan Patil		
		Altamash Hulsain	SEAIML	1 <sup>st</sup> runner	Mrs. Mrunali Kokate		
		Nimish Patil	TYElect	2 <sup>nd</sup> runner			
19)	Badminton Singles (Girls)		<u>22</u>		Sumit Pawaskar		
		Vini Patil	FYComp	Winner	Sama Khan		
		Manasree Doiphode	BE EXT C	1 <sup>st</sup> runner	Khushi Gupta		
		Hitakshi Patil	SE J T	2 <sup>nd</sup> runner	Aniket Wakade		
20)	Badminton Doubles (Boys)		<u>7x2=14</u>				
		Ameey Save	TYElect	Winner			
		Shrimat Nagarkar	TYComp	2 <sup>nd</sup>			
		Sumit Pawaskar	BE Mech	Winner			
		Kunal Raut	BE Mech	Winner			

Judges :

Chief Guest :

  
 Chief Co-ordinator  
 (Name & Signature)



  
 PRINCIPAL  
 THEEM COLLEGE OF ENGINEERING  
 At Village Betagad, Bosar Chikar Road  
 Bosar (East) Tal. & Dist. Palghar - 401 501



H. J. THIM TRUST'S

## THEEM COLLEGE OF ENGINEERING

### NOTICE

Date: 01/03/2023

All the students are hereby informed that, the college level Throwball (Girls) events will be starting from 06 Mar 2023. All the interested students should enroll your name as Group on or before 03 Mar 2023.

(Entry fees for Group /Team is Rs 50.)

Following Students Coordinators:-

RUTI (FE COMP)

MITALI (SE IT)

HALIMA (BE COMP)

ALISHA (TE IT)

#### Staff Coordinator

Prof. Sonali kartik

#### Sport Coordinator

Prof. Harshal Ahire

Prof. Ayaz Bagwan.



  
- PRINCIPAL  
THEEM COLLEGE OF ENGINEERING  
At Village Botegada, Bosisar Chlihar Road,  
Bosisar (East) Tal. & Dist. Palghar - 401 50

# JASHN-E-THEEM 2023

## THROWBALL

### 6 MAR 2023



**Student Coordinators**

**Ruti (FE Comp)**

**Halima (BE Comp)**

**Mithali (SE IT)**

**Alisha (TE IT)**

**Staff Coordinators**

**Prof Sonali Kartik (9503461683)**



  
- PRINCIPAL  
THEEM COLLEGE OF ENGINEERING  
AL Village Behegan, Bolisar Chikar Road  
Bolisar (East) Tal. & Dist. Polshar - 401 50





H. J. THIM TRUST'S  
**THEEM COLLEGE OF ENGINEERING**

Bosar Chikhar Road, Betagad, Bosar (E), Tal. & Dist.: Palghar - 401 501. • Tel.: +917709916126 • Mobile: www.theemcol.org

**REPORT OF JASHN-E-THEEM 2023 (ATHLON 23)**

Throwball (Intro)



Sr. No.	Event's Name	School/College Name	Number of Candidate	Result	Co-ordinator's Name (Staff & Student)	Photos (Y/N)	Remark
20	Throwball (Girls)		6x7=42		Prof. Sonali Kartik Mrs. Manalata J.		
		① BE Comps ② BE IT ③ TE Comps ④ JF & IJ ⑤ FE ⑥ Diploma			Alisha Shaikh Tijen Das Ayush Sankhe Chinmay Pimple Saniya Pedurkar Suyama Shaikh.		
		BE IT - runnerup BE Comps - winners. Player of the tournament. Alisha Shaikh - BE Comp					

Judges : \_\_\_\_\_  
 Chief Guest : \_\_\_\_\_

*Harshad*  
 Chief Co-ordinator  
 (Name & Signature)



*[Signature]*  
 PRINCIPAL  
 THEEM COLLEGE OF ENGINEERING  
 At Village Betagad, Bosar Chikhar Road,  
 Bosar (East) Tal. & Dist. Palghar - 401 501



H. J. THIM TRUST'S

## THEEM COLLEGE OF ENGINEERING

### NOTICE

Date: 01/03/2023

All the students are hereby informed that, the college level Kabaddi (Boys) events will be starting from 06<sup>th</sup> March 2023. All the interested students should enroll your name as Group on or before 3<sup>rd</sup> March 2023.

(Entry fees for Group /Team is Rs 100.)

Following Coordinators:-

CHIRAG (BE CIVIL)

SUMIT (TE MECH)

MAYUR (BE CIVIL)

RIZWAN (TE COMP)

**Staff Coordinator**

Prof. Sumit shelke

**Sport Coordinator**

Prof. Harshal Ahire

Prof. Ayaz Bagwan.



  
PRINCIPAL  
THEEM COLLEGE OF ENGINEERING  
At Village Betegaon, Bolar Chikhar Road,  
Bolar (East) Tal. & Dist. Palghar - 401 501



# JASHN-E-THEEM 2023

## KABADDI

### 6 MAR 2023



KABADDI

**Student Coordinators**

**Chirag (BE Civil)**

**Sumit (TE Mech)**

**Mayur (BE Civil)**

**Rizwan (TE Comp)**

**Staff Coordinators**

**Prof Sumit Shelke**



  
PRINCIPAL  
THEEM COLLEGE OF ENGINEERING  
AL. Village Behigadh, Borsar, Chikhar Road,  
Borsar (Dist. Tal. A. Dist. Palghar - 401 501)



H. J. THIM TRUST'S  
**THEEM COLLEGE OF ENGINEERING**

Bolsar Chikhar Road, Betagadon, Bolsar (E), Tal. & Dist.: Palghar - 401 501. • Tel.: +917708916108 • Website: www.theemcoe.org

**REPORT OF JASHN-E-THEEM 2023 (ATHLON 23)**



Kabaddi  
(Intra)

Sl. No.	Event's Name	School/College Name	Number of Candidate	Result	Co-ordinator's Name (Staff & Student)	Photos (Y/N)	Remark
22	Kabaddi (Boys)		11x10=10		Mr. Sumit shelke		
		① SY Comp ② 11th sci					
		③ TY Elect ④ SE Comp					
		⑤ SY CIVIL ⑥ TE A I M L					
		⑦ TY Mech ⑧ SE IT					
		⑨ TE Mech ⑩ FE					
		⑪ BE Comp					
		TY Electrical	winner				
		TE A I M L	1 <sup>st</sup> runner				
		Sudhir Pandey	TY Elect	Best rider			
		Rohit Chavan	TY Elect	Best defender			
		Ritvik Poojari	SY Elect	Player best			

Judges :

Chief Guest :

*[Signature]*  
 Chief Co-ordinator  
 (Name & Signature)



*[Signature]*  
 PRINCIPAL

THEEM COLLEGE OF ENGINEERING  
 A2 Village Betagadon, Bolsar Chikhar Road  
 Bolsar (East) Tal. & Dist. Palghar - 401 501



H. J. THIM TRUST'S

## THEEM COLLEGE OF ENGINEERING

### NOTICE

Date: 01/03/2023

All the students are hereby informed that, the college level Kho-Kho (Boys and Girls) events will be starting from 06 Mar 2023. All the interested students should enroll your name as Group on or before 03 Mar 2023.

(Entry fees for Group /Team is Rs 50.)

Following Students Coordinators:-

JUNED KHAN (TE CIVIL)

VAIBHAV (TE MECH)

RAZA (TE MECH)

#### Staff Coordinator

Prof. Shubham Dhodi

#### Sport Coordinator

Prof. Ansar shaikh

Prof. Ayaz Bagwan.



  
- PRINCIPAL  
THEEM COLLEGE OF ENGINEERING,  
At Village Betegadh, Boisar Chikhar Road,  
Boisar (East) Tal. & Dist. Palghar - 401 501



**JASHN-E-THEEM 2023**

**KHO-KHO**

**6 MAR 2023**



**Student Coordinators**  
**Juned Khan (TE Civil)**  
**Raza (TE Mech)**

**Vaibhav(TE Mech)**

**Staff Coordinators**  
**Prof Shubham Dhodi (9665595770)**



  
PRINCIPAL  
THEEM COLLEGE OF ENGINEERING  
At Village Bebgadh, Bolsar Chikhar Rd,  
Bolsar (Emet) Tal. & Dist. Patghar - 401 501



H. J. THIM TRUST'S  
**THEEM COLLEGE OF ENGINEERING**  
 Near Chikar Road, Betgaon, Bolar (E), Tal. & Dist: Palghar - 401 501 • Tel: +91776993130 • Website: www.theemcoe.org

Kho-Kho (Intro)



**REPORT OF JASHN-E-THEEM 2023 (ATHLON 23)**

Sr. No.	Event's Name	School/College Name	Number of Candidate	Result	Co-ordinator's Name (Staff & Student)	Photos (Y/N)	Remark
23	Kho-Kho (Boys)	① TY Elect ② TE Comp ③ Mechanical ④ FE ⑤ SY Comp ⑥ CIVIL ⑦ TY Mech	7x14=98		Prof. Shubham Dhodi Prof. Ibrahim Khan		
		TY Electrical		winner	Juneel Khan Vaibhav Rasal		
		SY Computer		1 <sup>st</sup> runner	Vedant		
		Rohit Chavam	SY Elect	Best Player			

Judges : \_\_\_\_\_  
 Chief Guest : \_\_\_\_\_

*Hushaf*  
 Chief Co-ordinator  
 (Name & Signature)



*[Signature]*  
 PRINCIPAL  
 THEEM COLLEGE OF ENGINEERING  
 A1, Village Betgaon, Bolar Chikar Road,  
 Bolar (East) Tal. & Dist. Palghar - 401 501







H. J. THIM TRUST'S

## THEEM COLLEGE OF ENGINEERING

### NOTICE

Date: 01/03/2023

All the students are hereby informed that, the college level Volleyball(Boys) events will be starting from 06 Mar 2023. All the interested students should enroll your name as Group on or before 03 Mar 2023.

(Entry fees for Group /Team is Rs 100.)

Following Students Coordinators:-

AYUDH SANKHE(TE COMP)

BHAVIK RIMPLE (TE IT)

CHINYOY PIMPLE(BE MECH)

#### Staff Coordinator

Prof. Harshal Ahire

Prof. Ayaz bagwan

#### Sport Coordinator

Prof. Harshal Ahire

Prof. Ayaz Bagwan.



  
PRINCIPAL  
THEEM COLLEGE OF ENGINEERING  
At Village Betegada, Bosisar Chikhar Road,  
Bosisar (East) Tal. & Dist. Palghar - 401 501

JASHN-E-THEEM 2023

Volleyball(Boys)

06 MAR 2023

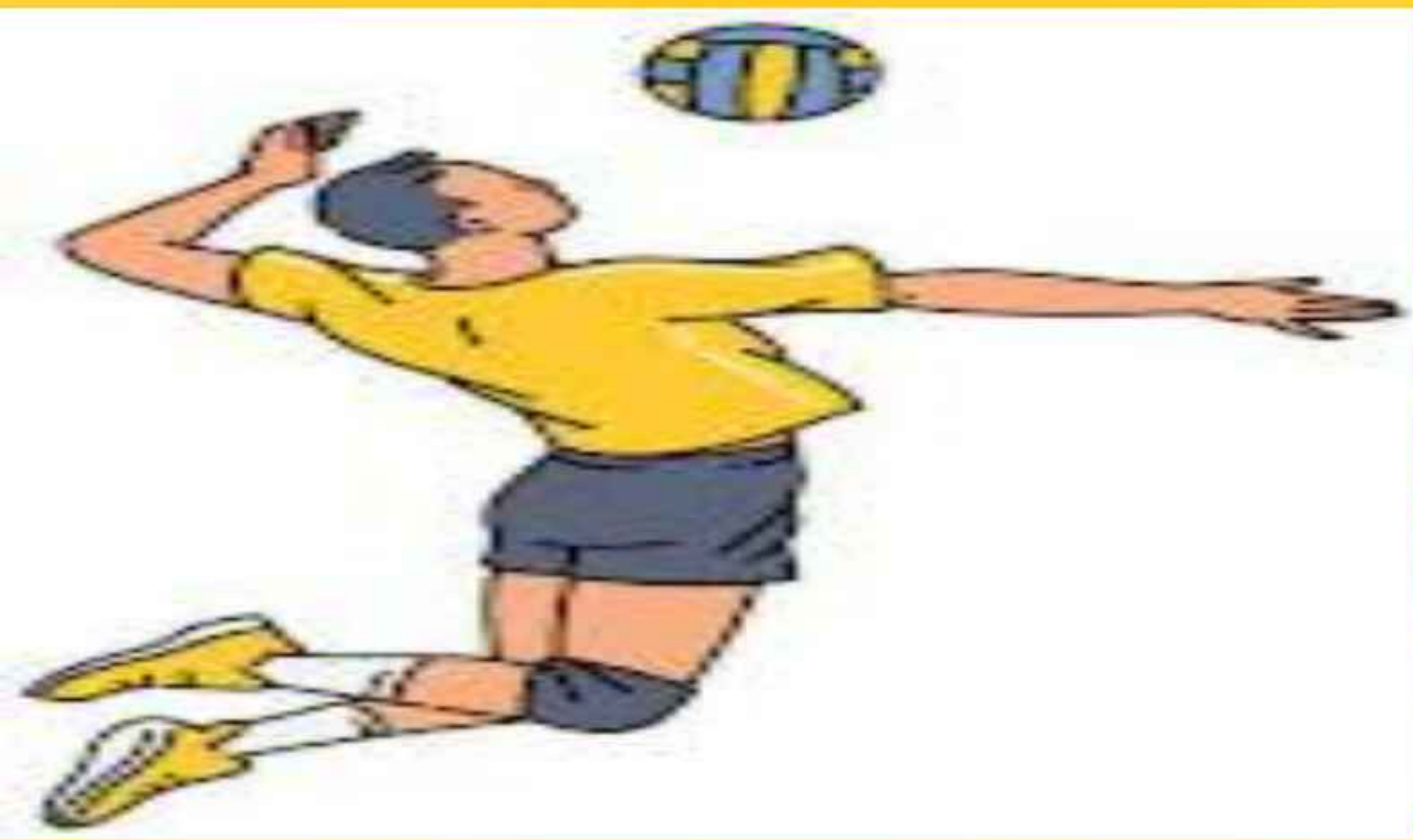

**Student Coordinators**

**Harshal Ahire (TE COMP)**

**Chinoy Pimple (BE Mech)**

**Bhavik Rimple(TE IT)**

**Staff Coordinators**

**Prof Harshal Ahire**

**Prof Ayaz Bagwan**



  
PRINCIPAL  
THEEM COLLEGE OF ENGINEERING  
AZ. Village Bebegadi, Bolisar Chikkar Road,  
Bolisar (Eret) Tal. & Dist. Palghar - 401 501



H. J. THIM TRUST'S  
**THEEM COLLEGE OF ENGINEERING**

Social Chikar Road, Betegam, Bolar (E), Tal. & Dist. Palghar - 401 501 • Tel: +917708916300 • Website: www.theemcol.org

**REPORT OF JASHN-E-THEEM 2023 (ATHLON 23)**

Volleyball (Intra)



Sl. No.	Event's Name	School/College Name	Number of Candidate	Result	Co-ordinator's Name (Staff & Student)	Photos (Y/N)	Remark
25	Volleyball (Boys)	① Mechanical ② Computer ③ SC AIML ④ TY Mech ⑤ BE CIVIL ⑥ REME ⑦ SE IT ⑧ T.E Comp ⑨ T. Velectric ⑩ FE (A) ⑪ SE Mech. ⑫ F.Y	12 x 10 = 120		Prof. Haidat A. Prof. AyaZ B.		
		SE AIML		winner	Jiten Dad Ayush Sankhe Chinmay Pimple Bhavik Pimple Sohil Bari		
		TY Mechanical		runnerup	Ajay Karankate		
		Altamash Hussain		best player	Ahmed Sameer Gufam Chiray Sankhe		

Judges :

Chief Guest :

*Haidat*  
 Chief Co-ordinator  
 (Name & Signature)



*Haidat*  
 PRINCIPAL  
 THEEM COLLEGE OF ENGINEERING  
 At Village Betegam, Bolar Chikar Road,  
 Bolar (East) Tal. & Dist. Palghar - 401 501



H. J. THIM TRUST'S

## THEEM COLLEGE OF ENGINEERING

### NOTICE

Date: 01/03/2023

All the students are hereby informed that, the college level Football (Boys) events will be starting from 06 Mar 2023. All the interested students should enroll your name as Group on or before 03 Mar 2023.

(Entry fees for Group /Team is Rs 50.)

Following Students Coordinators:-

ISMAIL (BE IT)

JAY VALEKAR (TE COMP)

AAKASH (BE ELE)

**Staff Coordinator**

Prof. Abid Manyar

**Sport Coordinator**

Prof. Harshal Ahire

Prof. Ayaz Bagwan.



  
PRINCIPAL  
THEEM COLLEGE OF ENGINEERING  
At Village Belegadi, Bolisar Chikhar Road,  
Bolisar (East) Tal. & Dist. Palghar - 401 501



# JASHN-E-THEEM 2023

## Football(Boys)

### 06 MAR 2023



**Student Coordinators**

**Ismail (BE IT)**

**Jay Valekar(TE COMP)**

**Aakash (BE ELE)**

**Staff Coordinators**

**Prof Abid Manyar (8983189619)**



  
**PRINCIPAL**  
THEEM COLLEGE OF ENGINEERING  
AL Village Betsada, BGSAR Chikar Road  
Bolsar (Erat) Tal. & Dist. Potaigar - 411 507



H. J. THIM TRUST'S  
**THEEM COLLEGE OF ENGINEERING**

Bolsar Chikhar Road, Betsaport Bolsar (T), Tal. & Dist. Palghar - 401 501. • Tel. +917702936105 • Website: www.theemcoe.org

**REPORT OF JASHN-E-THEEM 2023 (ATHLON 23)**

Football (Intra)  
 15<sup>th</sup> March 23



Sr. No.	Event's Name	School/College Name	Number of Candidate	Result	Co-ordinator's Name (Staff & Student)	Photos (Y/N)	Remark
26	Football (Boys)	① Computer ② IT ③ FE ④ TY Elect- ⑤ mechanical	5 X 16 = 80		Prof. Abid Manyar		
		Computer Engg. FE.		winner	Aman Dange Adarsh Dubey Ismail Shaikh		
		Adarsh Dubey	TE comp	runnerup	Fahim Shaikh Nischay Pandey		
		Abhishek Panchal	SR comp	Best G-k. Best striker			

Judges: Referee - 1) Mr. Puneet Raj (8669042138) 2) Mr. Shivam Yadav  
 3) Mr. Vivek.  
 Chief Guest:

*Handwritten Signature*  
 Chief Co-ordinator  
 (Name & Signature)



*Handwritten Signature*  
 PRINCIPAL  
 THEEM COLLEGE OF ENGINEERING  
 At Village Betegadi, Bolsar Chikhar Road,  
 Bolsar (East) Tal. & Dist. Palghar - 401 501.



H. J. THIM TRUST'S

## THEEM COLLEGE OF ENGINEERING

### NOTICE

Date: 10/03/2023

All the students are hereby informed that, the college level Tug of war (Boys and Girls) events will be starting from 15 Mar 2023. All the interested students should enroll your name as Group on or before 12 Mar 2023.

(Entry fees for Group /Team is Rs 50.)

Following Students Coordinators:-

UMAR KAHAN (TE COMP)

SWAPNIL (SE MECH)

SANIYA (TE IT)

BAVANA (TE ELE)

#### Staff Coordinator

Prof. Shubham Dhodi

Prof. Priti Mali

#### Sport Coordinator

Prof. Harshal Ahire

Prof. Ayaz Bagwan.



  
PRINCIPAL  
THEEM COLLEGE OF ENGINEERING  
At Village Betogad, Bolisar Chitkar Road,  
Bolisar (East) Tal. & Dist. Palghar - 401 50

# JASHN-E-THEEM 2023

## TUG OF WAR

### 15 MAR 2023

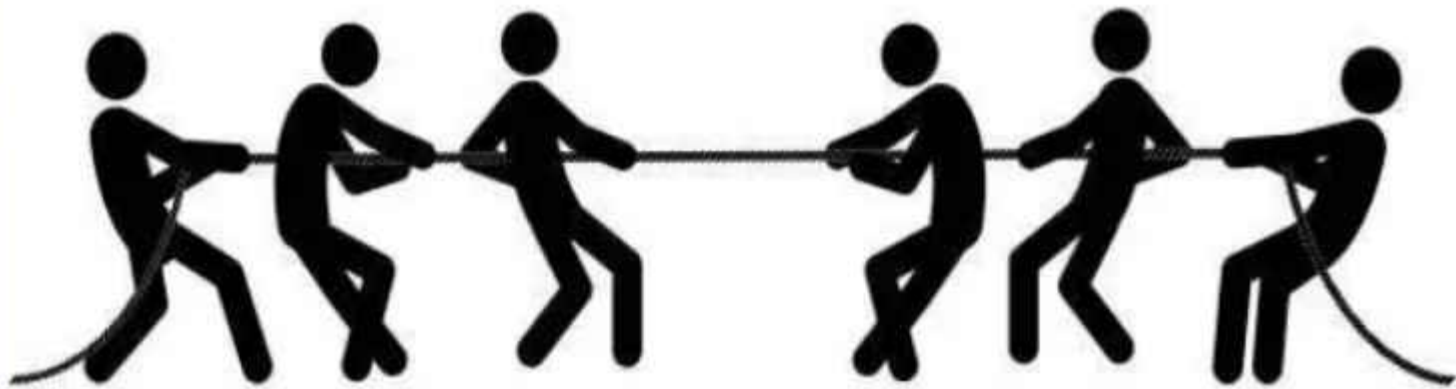

**Student Coordinators**

**UMAR KAHAN (TE COMP)**

**SANIYA (TE IT)**

**SWARNIL (SE MECH)**

**BAVANA(TE ELE)**

**Staff Coordinators**

**Prof Abid Manyar (8983189619)**

**Prof. Priti Mali**



  
**PRINCIPAL**  
THEEM COLLEGE OF ENGINEERING  
A2, Village Behrud, Boisar Chikar, Pal  
Boisar (East) Tal. & Dist. Palghar - 401 507





H. J. THIM TRUST'S  
**THEEM COLLEGE OF ENGINEERING**

Bosar Chikhar Road, Belegaon, Bolisar (E), Tal. & Dist. Palghar - 401 501. • Tel. : +91779990329 • Website : www.theemce.org

**REPORT OF JASHN-E-THEEM 2023 (ATHLON 23)**

Tug of War (Intro)



15th March 23

Sr. No.	Event's Name	School/College Name	Number of Candidate	Result	Co-ordinator's Name (Staff & Student)	Photos (Y/N)	Remark
27	Tug of War (Boys)	① TE IT ② BE IT ③ TE Camps ④ Mechanical ⑤ BE Camps	5 X 10 = 50		Prof. Shubham D. Prof. Priti Mali Mr. Neetish Kumar		
		B. E. IT B. E. Camp		winner runnup	Ajinkya Chavan Salman Tamboli Sayma Shaikh		
28	Tug of War (Girls)	BE-IT FY Camp	2 X 9 = 18	winner runnup	Muned Khan		

Judges :

Chief Guest :

*Handwritten Signature*  
 Chief Co-ordinator  
 (Name & Signature)



*Handwritten Signature*

PRINCIPAL  
 THEEM COLLEGE OF ENGINEERING  
 At Village Belegaon, Bolisar Chikhar Road  
 Bolisar (East) Tal. & Dist. Palghar - 401 501



H. J. THIM TRUST'S

## THEEM COLLEGE OF ENGINEERING

### NOTICE

Date: 02/03/2023

All the students are hereby informed that, the college level Box cricket (Boys) events will be starting from 06 Mar 2023. All the interested students should enroll your name as Group on or before 04 Mar 2023.

(Entry fees for Group /Team is Rs 50.)

Following Students Coordinators:-

NILESH (TE COMP)

MOHAN (SE IT)

SOHAM (SE AIML)

#### Staff Coordinator

Prof. Harshal Ahire

#### Sport Coordinator

Prof. Harshal Ahire

Prof. Ayaz Bagwan.



  
- PRINCIPAL  
THEEM COLLEGE OF ENGINEERING  
At Village Betegad, Boisar Chikhar Road,  
Boisar (East) Tal. & Dist. Palghar - 401 501

# JASHN-E-THEEM 2023

## BOX CRICKET

### 06 MAR 2023



**Student Coordinators**  
**NILESH (TE COMP)**  
**SOHAM (SE AIML)**

**MOHAN (SE IT)**

**Staff Coordinators**  
**Prof Harshal Ahire(8275124797)**



  
**PRINCIPAL**  
THEEM COLLEGE OF ENGINEERING  
At Village Belgaon, Borsari Chikar Road,  
Borsari (E.M.) Tal. & Dist. Palghar - 401 50





# H. J. THIM TRUST'S THEEM COLLEGE OF ENGINEERING

Bolsar Chithar Road, Betagapin, Bolsar (E), Tal. & Dist: Palghar - 401 501. Tel: +917709955129 • Website: www.theemcoe.org

## REPORT OF JASHN-E-THEEM 2023 (ATHLON 23)



Sr. No.	Event's Name	School/College Name	Number of Candidate	Result	Co-ordinator's Name (Staff & Student)	Photos (Y/N)	Remark
2-9	Boys Cricket (Boys)	① BE Elect. ② BE CIVIL ③ TE CIVIL ④ BE Mech-A ⑤ TE IT-B ⑥ SE Camp B ⑦ BE IT ⑧ SE Camp ⑨ Jr. College ⑩ TE IT ⑪ SE AIML ⑫ BE Mech-B ⑬ BE Camp ⑭ Camps DIP ⑮ TY Camp ⑯ BE Camp B ⑰ FE ⑱ FY DIP ⑲ TY Mech ⑳ TE Camp ㉑ SE IT ㉒ BE IT-C ㉓ SE IT ㉔ TE AIML ㉕ TY Elect ㉖ BE Camp ㉗ FE-B	27x11 = 297		1) Prof. Abhishek M. 2) Prof. Vishwajeet B. 3) Mr. Bilal 4) Ronit Singh Arman Shaikh Yasim Shaikh Manya Markande Jethu Mohd. Kapkan Savvar Ahmed.		
					<u>Result</u>		
					B. E. CIVIL		Winner
					B. E. Electrical		runnerup
					Chinmay Gharat		Best Player

Judges :

Chief Guest :

Chief Co-ordinator  
(Name & Signature)



PRINCIPAL  
THEEM COLLEGE OF ENGINEERING  
At Village Betagapin, Bolsar Chithar Road  
Bolsar (East) Tal. & Dist. Palghar - 401 501





H. J. THIM TRUST'S

## THEEM COLLEGE OF ENGINEERING

### NOTICE

Date: 17/03/2023

All the students are hereby informed that, the college level cricket (Girls) events will be starting from 21 Mar 2023. All the interested students should enroll your name as Group on or before 19 Mar 2023.

(Entry fees for Group /Team is Rs 50.)

Following Students Coordinators:-

ANJALI (BE COMP)

SMRUTHI (TE COMP)

MATRI (BE IT)

#### Staff Coordinator

Prof. Harshal Ahire

Prof Hemalata j

#### Sport Coordinator

Prof. Harshal Ahire

Prof. Ayaz Bagwan.



  
PRINCIPAL  
THEEM COLLEGE OF ENGINEERING  
At Village Betogad, Bolsar Chikhar Road  
Bolzar (East) Tal. & Dist. Palghar - 401 50

# JASHN-E-THEEM 2023 CRICKET (GIRLS)

## 21 MAR 2023



**Student Coordinators**  
**ANJALI (BE COMP)**  
**MAITRI (BE IT)**

**SMRUTHI (TE COMP)**

**Staff Coordinators**  
**Prof Harshal Ahire(8275124797)**



*[Signature]*  
PRINCIPAL  
THEEM COLLEGE OF ENGINEERING  
AL, Village Batopada, Bolar Chikhar Rd,  
Bolar (Ermli Tal. & Dist. Parghar) 401501



H. J. THIM TRUST'S  
**THEEM COLLEGE OF ENGINEERING**

Kasar Chikar Road, Bebgan, Bolser (E), Tal. & Dist. Palghar - 401 501. • Tel. +917729716309 • Website: www.theemcoe.org

**REPORT OF JASHN-E-THEEM 2023 (ATHLON 23)**

Girls Cricket  
(Jr.col)



Sl. No.	Event's Name	School/College Name	Number of Candidate	Result	Co-ordinator's Name (Staff & Student)	Photos (Y/N)	Remark
50	Cricket (Girls)	① IT-A ② IT-B	6x10=60		Prof. Ayaz Bagwan		
		③ Comp-A ④ Comp-B			Ms. Afande		
		⑤ Diploma ⑥ Jr.college			Mrs. Hemabata J.		
		Jr. College		winner	Arsalan Shaikh		
		IT-A		runnerup	Sanchit Ramane		
					Prapti Patil		
					Alisha Shaikh.		
		Rutuja Jadhav	Best Batter	TE IT			
		Hatima Khan	Best Bowler	11 <sup>th</sup> sci			
		Muskan Chabour	Best Player	11 <sup>th</sup> sci			

Judges : \_\_\_\_\_  
 Chief Guest : \_\_\_\_\_

*Mashaf*  
 Chief Co-ordinator  
 (Name & Signature)



*[Signature]*  
 PRINCIPAL  
 THEEM COLLEGE OF ENGINEERING  
 At Village Bebgan, Bolser Chikar Road,  
 Bolser (East) Tal. & Dist. Palghar - 401 501.



H. J. THIM TRUST'S

## THEEM COLLEGE OF ENGINEERING

### NOTICE

Date: 01/03/2023

All the students are hereby informed that, the college level Open cricket intra (Boys) events will be starting from 04 Mar 2023. All the interested students should enroll your name as Group on or before 02 Mar 2023.

(Entry fees for Group /Team is Rs 50.)

Following Students Coordinators:-

JUNED KHAN (BE CIVIL)

VAIBHAV (BE CIVIL)

**Staff Coordinator**

Prof. Harshal Ahire

**Sport Coordinator**

Prof. Harshal Ahire

Prof. Ayaz Bagwan.



  
- PRINCIPAL  
THEEM COLLEGE OF ENGINEERING...  
At Village Betegad, Boisar Chikhar Road,  
Boisar (East) Tal. & Dist. Patghar - 401 501



# JASHN-E-THEEM 2023 CRICKET (GIRLS)

21 MAR 2023



**Student Coordinators**  
**ANJALI (BE COMP)**  
**MAITRI (BE IT)**

**SMRUTHI (TE COMP)**

**Staff Coordinators**  
**Prof Harshal Ahire(8275124797)**



*Principle*  
**PRINCIPAL**  
THEEM COLLEGE OF ENGINEERING  
At: Village Botogad, Borner Chikkar, P.  
Hosur (Dist) Tal. A. Ch. P. Palghar - 401 50



# H. J. THIM TRUST'S THEEM COLLEGE OF ENGINEERING

Bolsar Chikhar Road, Belagach, Bolsar (E), Tal. & Dist. Palghar - 401 501. • Tel: +917769555029 • Website: www.theemcoe.org

## REPORT OF JASHN-E-THEEM 2023 (ATHLON 23)

Open cricket  
(Int)



4<sup>th</sup> March to  
13<sup>th</sup> March

Sr. No.	Event's Name	School/College Name	Number of Candidate	Result	Co-ordinator's Name (Staff & Student)	Photos (Y/N)	Remark
31	Open cricket (Boys)	① FE-C ② SE elect ③ TEMech	23x14=322		Prof. Mohd. Aquib Mr. Sumit Mhatre Mr. Priyanshu Thakur		
		④ SY civil ⑤ TE comp ⑥ SE comp					
		⑦ SEMech ⑧ FY elect ⑨ AFML					
		⑩ FE-B ⑪ BE elect ⑫ FY comp					
		⑬ SE IT ⑭ TE AML ⑮ TE IT					
		⑯ TE CIVIL ⑰ SEMech ⑱ FY Elect			Arsalan Shaikh Ruti fakki Tejas Patil Harsh Jadhav		
		⑲ BE Comp A ⑳ BE Comp B					
		㉑ SY Comp ㉒ BE IT ㉓ BE Civil					
		BE CIVIL		Winner	Sanchit Bamane		
		FY Comp		Runnerup	Saurav Singh		
		Manthan Sankhe	FY comp	Best Bowler	Ajay Karankale		
		Ganesh Vartha	BE civil	Best batsman	Mohd. Raza		
		Chimmay Gharat	BE civil	Best player	Owais Shaikh		

Judges :

Chief Guest :

*Houhal*  
Chief Co-ordinator  
(Name & Signature)



*[Signature]*  
PRINCIPAL  
THEEM COLLEGE OF ENGINEERING  
AL Village Belagach, Bolsar Chikhar Road  
Bolsar (East) Tal. & Dist. Palghar - 401 501



H. J. THIM TRUST'S

## THEEM COLLEGE OF ENGINEERING

### NOTICE

Date: 01/03/2023

All the students are hereby informed that, the college level Open cricket inter (Boys) events will be starting from 04 Mar 2023. All the interested students should enroll your name as Group on or before 02 Mar 2023.

(Entry fees for Group /Team is Rs 50.)

Following Students Coordinators:-

CHINMAY (BE CIVIL)

KAIWLAY (SE MECH)

VIPUL (BE CIVIL)

#### Staff Coordinator

Prof. Harshal Ahire

#### Sport Coordinator

Prof. Harshal Ahire

Prof. Ayaz Bagwan.



  
- PRINCIPAL  
THEEM COLLEGE OF ENGINEERING  
At Village Betegadh, Boisar Chithar Road,  
Boisar (East) Tal. & Dist. Palghar - 401 501





H. J. THIM TRUST'S  
**THEEM COLLEGE OF ENGINEERING**

Bolar Chikar Road, Bebgad, Bolser (E) Tal. & Dist. Palghar - 401 501. • Tel. +917760936109 • Website : www.theemcolleofe.org

**REPORT OF JASHN-E-THEEM 2023 (ATHLON 23)**

Open Cricket  
 (Inter)  
 14/03/23



Sr. No.	Event's Name	School/College Name	Number of Candidate	Result	Co-ordinator's Name (Staff & Student)	Photos (Y/N)	Remark
32	Open Cricket (Boys) (Inter).	1) St John Degree 1	11 x 14 = 154		Prof. Hareesh A		
		2) St John Degree 2			Prof. Ayaz B		
		3) St John Humanity					
		4) Niva Degree					
		5) Deep College					
		6) Chafekar College					
		7) Theem College (Pipha)					
		8) St John (Diploma)					
		9) SDSM Palghar (01)					
		10) SDSM, Palghar		Runnerup (300) -			
		11) Theem CoE, (Degree)		Winner (500) -			

Judges : \_\_\_\_\_  
 Chief Guest : \_\_\_\_\_

  
 Chief Co-ordinator  
 (Name & Signature)



  
 PRINCIPAL  
 THEEM COLLEGE OF ENGINEERING  
 AL Village Bebgad, Bolser Chikar Road  
 Bolser (East) Tal. & Dist. Palghar - 401 501





H. J. THIM TRUST'S

## THEEM COLLEGE OF ENGINEERING

### NOTICE

Date: 09/03/2023

All the students are hereby informed that, the college level Volleyball Inter(Boys) events will be starting from 14 Mar 2023. All the interested students should enroll your name as Group on or before 11 Mar 2023.

(Entry fees for Group /Team is Rs 100.)

Following Students Coordinators:-

AYUDH SANKHE(TE COMP)

BHAVIK RIMPLE (TE IT)

CHINYOY PIMPLE(BE MECH)

#### Staff Coordinator

Prof. Harshal Ahire

Prof. Ayaz bagwan

#### Sport Coordinator

Prof. Harshal Ahire

Prof. Ayaz Bagwan.



  
PRINCIPAL  
THEEM COLLEGE OF ENGINEERING  
At Village Betegad, Boisar Chikhar Road,  
Boisar (East) Tal. & Dist. Palghar - 401 501



# H. J. THIM TRUST'S THEEM COLLEGE OF ENGINEERING

Bosar Chikhar Road, Betagao, Boisar (E), Tal. & Dist. Palghar - 401 501 • Tel. +91 7799916339 • Website: www.theemcoe.org

## REPORT OF JASHN-E-THEM 2023 (ATHLON 23)



Sr. No.	Event's Name	School/College Name	Number of Candidate	Result	Co-ordinator's Name (Staff & Student)	Photos (Y/N)	Remark
52	Volleyball (Boys) (Inter)	① St. John BMS, Palghar	12 x 12 = 144		Prof. Harshad A. Prof. AYAZ B		
		② Yashwantrao Chatekar, Palghar					
		③ SDSM, Palghar					
		④ SFIT, Borivale	→	Runnerup (1200/-)	Jiten Daul Ayush Sankhe Chinmay Pimple Bhavik Pimple Sohil Bam Ajay karanakale Atmad sameer Gufan Chirag Sankhe		
		⑤ S.D. Vartak, Boisar					
		⑥ TVM, Boisar					
		⑦ HD Save, Tasaful					
		⑧ VIVA, Virar					
		⑨ Theem CoE (DIP)					
		⑩ Theem CoE, (Degre)					
		⑪ SRVM, Palghar					
		⑫ SJCEM, Palghar	→	Winner (3000/-)			

Judges : \_\_\_\_\_  
Chief Guest : \_\_\_\_\_

*Harshad*  
Co-ordinator  
(Name & Signature)



*[Signature]*  
PRINCIPAL  
THEEM COLLEGE OF ENGINEERING  
At Village Betagao, Boisar Chikhar Road,  
Boisar (East) Tal. & Dist. Palghar - 401 501



H. J. THIM TRUST'S  
**THEEM COLLEGE OF ENGINEERING**  
**JASHN-E-THEEM**

**2023**

**KALANJALI**

**2.0**

**13th - 18th**  
**MARCH-2023**

**Chief Co-ordinator:- Prof. Abriya Shaikh**

(Secretary)  
**Mr. Abubakr Thim**  
**(8459700334)**

(Deputy Secretary)  
**Miss. Anjali Purohit**  
**(9408592827)**



*[Signature]*  
PRINCIPAL  
THEEM COLLEGE OF ENGINEERING  
AL WILAYAT AL KHAYMA, DUBAI, U.A.E.  
Phone: (Em) 04 551 1111





H. J. THIM TRUST'S  
**THEEM COLLEGE OF ENGINEERING**  
**JASHN-E-THEEM**

**2023**

**KALANJALI**



**2.0**



**13th - 18th**  
**MARCH-2023**

**Chief Co-ordinator:- Prof. Abriya Shaikh**

(Secretary)  
Subakr Thim  
(9408592827)



PRINCIPAL  
THEEM COLLEGE OF ENGINEERING  
At Village - Bogada, District - Solapur  
Solapur - 431 001 & Dist. Mahara. 43

(Deputy Secretary)  
Miss. Anjali Purohit  
(9408592827)



# ASHN-E-THEEM FETE EVENT

13TH -18TH MARCH 2023

10:00 am - 04:00 pm



CO-ORDINATOR

ADITYA SHAIKH

CO-ORDINATOR

ADITYA BHOI

STUDENT CO-ORDINATOR

SAFIA DARVESH -8652774801

PRATHAMESH PATIL -9209096000

HARSHIT PRAJAPATI -8600469717

HIMANSHU PATIL -9156145101

HARSH GAIKAR -8793808810

SECRETARY

ABUBAKR THIM

DEPUTY SECRETARY

ANJALI PUROHIT





H. J. THIM TRUST'S

# Theem College of Engineering, Boisar

Approved by AICTE (New Delhi) Government of Maharashtra & DTE  
Affiliated to University of Mumbai Est. : - 2009 - 2010



## Jashn-e-Theem 2023

Category: Technical/ Sports/ Cultural (Tick any one)

Date: \_\_\_\_\_

Name of Event: FETE

Name of Winner: (In Capital Letters Only)

Type: Intra/Inter

Sr.No	Name	Branch	Year	Mob. No.
1	Sanj Patil	Comp	TY	8830370631
2	Neha Sankhe	Comp	TY	9322684280
3	Ritesh Dhodi	EE	TY	9307178706
4	Mahek Shaikh	Comp	TY	7517275867
5	Virendra Rajput	Comp	SY	8421713782
6	Fardeen Ansari	ME	TY	8010015234
7				
8				
9				
10				
11				
12				
13				
14				

*Arbiya Shaikh*  
Head



Received by:

Prof.

P.D Head

*[Signature]*  
PRINCIPAL  
THEEM COLLEGE OF ENGINEERING  
Al Village, Dahanu, District Dahanu, Tal.  
Boisar (East) Tal. & Dist. Palghar - 411 01



# Jashn-e-Theem 2023

Category: Technical/ Sports/ Cultural (Tick any one)

Name of Event: FETE

Date: \_\_\_\_\_

Name of 1<sup>st</sup> Runner-Up: (In Capital Letters Only)

Type: Intra/Inter

Sr.No	Name	Branch	Year	Mob. No.
1	Sabista Shaikh	BE-IT		9373012461
2	Ritika Kandare	BE-IT		8806912844
3	Kancej fatima Shaikh	BE-IT		9637466196
4				
5				
6				
7				
8				
9				
10				
11				
12				
13				
14				

  
 Head

Received by:

Prof.

P.D Head

Arbiya Shaikh



  
 PRINCIPAL  
 THEEM COLLEGE OF ENGINEERING,  
 AL Village Bhilgaon, Boisar Taluka, Dist. Palghar - 401 21



H. J. THIM TRUST'S

## THEEM COLLEGE OF ENGINEERING

### NOTICE

Date: 01/03/2023

All the students are hereby informed that, the college level Cultural Days Celebration (Boys and Girls) events will be starting from 6<sup>th</sup> March 2023. All the interested students should enroll your name as an Individual or Group on or before 3<sup>rd</sup> March 2023.

(Entry fees for Individual are Rs 10 and for Group /Team is Rs 40.)

Following Coordinators:-

MUSKAN CHABLU (BE COMP)	SANIYA SHAIKH(SE AIML)
RITIK KHANDARE (SE IT)	TEJAS PATIL(TE ELE)

#### Staff Coordinator

Prof . Ketaki Patil

Prof . Jagruti More

Prof. Monika Pathare

Prof Shahegul

#### Cultural Coordinator

Prof. Arbiya Shaikh



  
- PRINCIPAL  
THEEM COLLEGE OF ENGINEERING -  
At Village Betegad, Boisar Chikhar Road,  
Boisar (East) Tal. & Dist. Palghar - 401 501



# ASHN-E-THEEM 2023

Kalanjali 2.0

# CULTURAL DAYS Celebration

**Mismach Day**

**06-03-2023**

**Group Day**

**08-03-2023**

**Bollywood Day**

**09-03-2023**

**Traditional Day**

**10-03-2023**

( Co Ordinator )  
 vi Mokashi  
 9128180  
 iya Sane  
 6108550  
 ye Golatkar  
 5946579  
 et Pawade  
 8226923  
 an Patil

( Diploma Co Ordinator )  
 Priyanka Sahu  
 8857012973  
 Shivam Thakur  
 9067310065  
 Ali Raza Koke  
 9503391722  
 Vaishnavi Desai  
 7400333002  
 Manali patil

( Staff Co Ordinator )  
 Prof. Ketaki Patil (9545802029)  
 Prof. Jagruti More (7276760121)  
 Prof. Monika Pathare (9890857548)  
 Prof. Shahegul (9637057453)  
 Prof. Madhuri Bhoir (8149195743)  
 Prof. Rupali K (9284991228)  
 Mrs. Shweta Saokhe (9975247067)



*[Signature]*  
 PRINCIPAL  
 THEEM COLLEGE OF ENGINEERING  
 At Village Behayad, Boisar Chikar Road  
 Boisar (E) Dist. Tal. & Dist. Palghar - 401 02

Class 13/0



H. J. THIM TRUST'S  
**Theem College of Engineering, Boisar**

Approved by AICTE (New Delhi) Government of Maharashtra & DTE  
 Affiliated to University of Mumbai Est.: - 2009 - 2010

# Jashn-e-Theem 2023

## List of Winner of Individual Event

Category: Technical/ Sports/ Cultural (Tick any one)

*Mismatch Day*

Date: 06/08/2023

Name of Event: MISMATCH DAY

Kindly award Certificate and Medals/ Trophies to the following students.

Name of Winner: (In Capital Letters Only)

MONIKA SAMIR PATHARE

Name of Winner

Branch: COMPUTER. Year: PROF. Mob. No. 9890854548

Name of 1<sup>st</sup> Runner-Up: In Capital Letters Only)

ARBIYA SHAIKH / SNEHAL PATIL

Name of 1<sup>st</sup> Runner-Up

Branch: F.E (Science & Humanities) Year: PROF Mob. No. 9875417838 (Arbiya)  
8149585212 (Snehal)

Name of 2<sup>nd</sup> Runner-Up: In Capital Letters Only)

Name of 2<sup>nd</sup> Runner-Up

Branch: \_\_\_\_\_ Year: \_\_\_\_\_ Mob. No. \_\_\_\_\_



Head

Received by:

Prof.

P.D Head

*[Signature]*  
 PRINCIPAL  
 THEEM COLLEGE OF ENGINEERING  
 At Village Betegadh, Boisar Chikhar Road  
 Boisar (East) Tal. & Dist. Palghar - 401 501





**H. J. THIM TRUST'S**  
**Theem College of Engineering, Boisar**

Approved by AICTE (New Delhi) Government of Maharashtra & DTE  
 Affiliated to University of Mumbai Est.: - 2009 - 2010

**Jashn-e-Theem 2023**

**List of Winner of Individual Event**

Category: Technical/ Sports/ Cultural (Tick any one)

Date: 10/03/2023

Name of Event: TRADITIONAL DAY

Kindly award Certificate and Medals/ Trophies to the following students.

Name of Winner: (In Capital Letters Only)

E K T A T A N D E L

Name of Winner

Branch: Diploma(Elect) Year: Prof. Mob. No. 7219847950

Name of 1<sup>st</sup> Runner-Up: In Capital Letters Only)

EMILY GOSH

Name of 1<sup>st</sup> Runner-Up

Branch: F.E Year: Prof Mob. No. 9545822792

Name of 2<sup>nd</sup> Runner-Up: In Capital Letters Only)

Name of 2<sup>nd</sup> Runner-Up

Branch: \_\_\_\_\_ Year: \_\_\_\_\_ Mob. No. \_\_\_\_\_



Prof. \_\_\_\_\_ Head

Received by:

Prof. \_\_\_\_\_ P.D Head

PRINCIPAL  
 THEEM COLLEGE OF ENGINEERING  
 AL Village Bhatpada, Boisar District, Raol  
 Bolpur (East) Tal. & Dist. Palghar - 401 051

staff  
Bollywood



H. J. THIM TRUST'S

# Theem College of Engineering, Boisar

Approved by AICTE (New Delhi) Government of Maharashtra & DTE  
Affiliated to University of Mumbai Est.: - 2009 - 2010

## Jashn-e-Theem 2023

### List of Winner of Individual Event

Category: Technical/ Sports/ Cultural (Tick any one) Bollywood

Date: 09/03/2023

Name of Event: BOLLYWOOD DAY

Kindly award Certificate and Medals/ Trophies to the following students.

Name of Winner: (In Capital Letters Only)

SUREKHA ATTARDE

Name of Winner

Branch: Electrical Year: Lab. Ass. Mob. No. \_\_\_\_\_

Name of 1<sup>st</sup> Runner-Up: (In Capital Letters Only)

JAGRUTI MORE

Name of 1<sup>st</sup> Runner-Up

Branch: COMPUTER Year: Prof. Mob. No. 7276760121

Name of 2<sup>nd</sup> Runner-Up: (In Capital Letters Only)

\_\_\_\_\_

Name of 2<sup>nd</sup> Runner-Up

Branch: \_\_\_\_\_ Year: \_\_\_\_\_ Mob. No. \_\_\_\_\_



\_\_\_\_\_  
Head

Received by:

Prof.

P.D Head

PRINCIPAL  
THEEM CHALLENGE OF ENGINEERING  
At Village: Boisar, Boisar College Road  
Boisar (Dist) Tal. A. Dist. Palghar - 401 12



H. J. THIM TRUST'S

# Theem College of Engineering, Boisar

Approved by AICTE (New Delhi) Government of Maharashtra & DTE  
Affiliated to University of Mumbai Est.: - 2009 - 2010

## Jashn-e-Theem 2023

### List of Winner of Individual Event

Category: Technical/ Sports/ Cultural (Tick any one)

Mismatch

Junior (C)  
Date: 06/03/2023

Name of Event: MISMATCH DAY

Kindly award Certificate and Medals/ Trophies to the following students.

Name of Winner: (In Capital Letters Only)

MUSKAN CHABLU

Name of Winner

Branch: JUNIOR COLLEGE Year: 11<sup>th</sup> Mob. No. \_\_\_\_\_

Name of 1<sup>st</sup> Runner-Up: In Capital Letters Only)

DANIYA SHAIKH

Name of 1<sup>st</sup> Runner-Up

Branch: JUNIOR COLLEGE Year: 11<sup>th</sup> Mob. No. \_\_\_\_\_

Name of 2<sup>nd</sup> Runner-Up: In Capital Letters Only)

\_\_\_\_\_

Name of 2<sup>nd</sup> Runner-Up

Branch: \_\_\_\_\_ Year: \_\_\_\_\_ Mob. No. \_\_\_\_\_



[Signature]  
PRINCIPAL

THEEM COLLEGE OF ENGINEERING  
AL Village Belegach, Boisar Chikar Road  
Boisar (East) Tal. & Dist. Palghar - 401 50

Head

Received by:

Prof.

P.D Head



Students  
(Girls)

# Jashn-e-Theem 2023

## List of Winner of Individual Event

Category: Technical/ Sports/ Cultural (Tick any one)

Date: 06/09/2023

Name of Event: MISMATCH DAY

Kindly award Certificate and Medals/ Trophies to the following students.

Name of Winner: (In Capital Letters Only)

R	I	Y	A	J	H	A													
---	---	---	---	---	---	---	--	--	--	--	--	--	--	--	--	--	--	--	--

Name of Winner

Branch: COMP Year: B.E Mob. No. 8454916281

Name of 1<sup>st</sup> Runner-Up: In Capital Letters Only)

R	U	P	T	I	B	H	O	I	R										
---	---	---	---	---	---	---	---	---	---	--	--	--	--	--	--	--	--	--	--

Name of 1<sup>st</sup> Runner-Up

Branch: DIPLOMA Year:  Mob. No.

Name of 2<sup>nd</sup> Runner-Up: In Capital Letters Only)

O	M	A	L	S	I	D	D	H	A	R	T	H								
---	---	---	---	---	---	---	---	---	---	---	---	---	--	--	--	--	--	--	--	--

Name of 2<sup>nd</sup> Runner-Up

Branch: AIML Year: S.E Mob. No.

*[Signature]*  
 PRINCIPAL  
 THEEM COLLEGE OF ENGINEERING  
 AL Village Bologach, Boisar Chiplat Road  
 Boisar (East) Tal. & Dist. Palghar - 401 50



Head

Received by:

Prof.

P.D Head



Students  
Boys

H. J. THIM TRUST'S

**Theem College of Engineering, Boisar**

Approved by AICTE (New Delhi) Government of Maharashtra & DTE.  
Affiliated to University of Mumbai Est.: - 2009 - 2010

# Jashn-e-Theem 2023

## List of Winner of Individual Event

Category: Technical/ Sports/ Cultural (Tick any one)

Date: 06/03/2028.

Name of Event: MISMATCH DAY

Kindly award Certificate and Medals/ Trophies to the following students.

Name of Winner: (In Capital Letters Only)

ITIK KHANDARE

Name of Winner

Branch: IT Year: B.E Mob. No. \_\_\_\_\_

Name of 1<sup>st</sup> Runner-Up: In Capital Letters Only)

AIDER BAGASRAWALA

Name of 1<sup>st</sup> Runner-Up

Branch: COMP Year: T.E Mob. No. 8149764996

Name of 2<sup>nd</sup> Runner-Up: In Capital Letters Only)

OHDIRFAN

Name of 2<sup>nd</sup> Runner-Up

Branch: IT Year: S.E Mob. No. \_\_\_\_\_



Head

Received by:

Prof.

P.D Head

*[Signature]*  
PRINCIPAL  
THEEM COLLEGE OF ENGINEERING  
At Village Belgaon, Boisar Taluka, Dist. Palghar - 401 50



H. J. THIM TRUST'S  
**Theem College of Engineering, Boisar**

Approved by AICTE (New Delhi) Government of Maharashtra & DTE  
Affiliated to University of Mumbai Est.: - 2009 - 2010

# Jashn-e-Theem 2023

Category: Technical/ Sports/ Cultural (Tick any one)

Group Day

Date: 08/03/2023

Name of Event: GROUP DAY

Name of Winner: (In Capital Letters Only)

Type: Intra/Inter

Sr.No	Name	Branch	Year	Mob. No.
1	TEJAS PATIL	CIVIL	TY	
2	VEDANT RAUT	ELECT	TY	
3	VRUSHANT DHANPAL			
4	SURESH KASAR	COMP		
5	NED PURANDERE			
6	DHRU SANKHE			
7				
8				
9				
10				
11				
12				
13				
14				

Prof.

Head

Received by:

Prof.

P.D Head



  
PRINCIPAL  
THEEM COLLEGE OF ENGINEERING  
At, Village Bohisar, Boisar (District Thane)  
Boisar (East) Tal. & Dist. Palghar - 401 501

# Jashn-e-Theem 2023

Category: Technical/ Sports/ Cultural (Tick any one)  Cultural

Date: 08/08/2024

Name of Event: GROUP DAY

Name of 1<sup>st</sup> Runner-Up: (In Capital Letters Only)

Type: Intra/Inter

Sr.No	Name	Branch	Year	Mob. No.
1	HARSHIT PRAJAPATI	COMPS		
2	HARGH GAIKAR			
3	HIMANSHU PATIL			
4	RAJ CHAVAN			
5	RIDDISH SANKHE			
6	PRATHAMESH PATIL			
7				
8				
9				
10				
11				
12				
13				
14				

Head

Received by:

Prof.

P.D Head

*[Signature]*  
 PRINCIPAL  
 THEEM COLLEGE OF ENGINEERING  
 At Village: Boisar, Tal. Boisar, Dist. Palghar - 401 512







H. J. THIM TRUST'S

# Theem College of Engineering, Boisar

Approved by AICTE (New Delhi) Government of Maharashtra & DTE  
Affiliated to University of Mumbai Est.: - 2009 - 2010

## Jashn-e-Theem 2023

Category: Technical/ Sports/ Cultural (Tick any one)

Date 08/03/2023

Name of Event: GROUP DAY

Name of 2<sup>nd</sup> Runner-Up: (In Capital Letters Only)

Type: Intra/Inter

Sr.No	Name	Branch	Year	Mob. No.
1	ARCHIS SAVE	IT	TE	
2	AADITYA GUPTA	-H-	-H-	
3	AARHAL YADAV	-H-	-H-	
4	PRANAY PARAB	-H-	-H-	
5				
6				
7				
8				
9				
10				
11				
12				
13				
14				

Head

Received by:

Prof.

P.D Head

PRINCIPAL

THEEM COLLEGE OF ENGINEERING  
At Village Betogad, Boisar Chikhar Road  
Boisar (East) Tal. & Dist. Palghar - 401 50



(Boys)  
Bollywood



H. J. THIM TRUST'S  
**Theem College of Engineering, Boisar**

Approved by AICTE (New Delhi) Government of Maharashtra & DTE  
Affiliated to University of Mumbai Est. - 2009 - 2010

# Jashn-e-Theem 2023

## List of Winner of Individual Event

Category: Technical/ Sports/ Cultural (Tick any one)

Date: 09/03/2023.

Name of Event: BOLLYWOOD DAY

Kindly award Certificate and Medals/ Trophies to the following students.

Name of Winner: (In Capital Letters Only)

FAIZAN GURESHI & RUPAI PAKKI

Name of Winner

Branch: COMPUTER Year: B.E Mob. No. 8278610518  
9049171539

Name of 1<sup>st</sup> Runner-Up: In Capital Letters Only)

NAVEED

Name of 1<sup>st</sup> Runner-Up

Branch: AIML Year: S.E Mob. No. \_\_\_\_\_

Name of 2<sup>nd</sup> Runner-Up: In Capital Letters Only)

GARVESH

Name of 2<sup>nd</sup> Runner-Up

Branch: Comps (DIP) Year: \_\_\_\_\_ Mob. No. \_\_\_\_\_



Prof.

Head

*[Signature]*  
PRINCIPAL

Received by:

Prof.

P.D Head

THEEM COLLEGE OF ENGINEERING,  
Village Betegada, Boisar Chikhar Road,  
Boisar (East) Tal. & Dist. Palghar - 401 50.

Girls  
Bollywood

**H. J. THIM TRUST'S**  
**Theem College of Engineering, Boisar**  
Approved by AICTE (New Delhi) Government of Maharashtra & DTE  
Affiliated to University of Mumbai Est.: - 2009 - 2010

# Jashn-e-Theem 2023

## List of Winner of Individual Event

Category: Technical/ Sports/ Cultural (Tick any one)

Name of Event: Bollywood Day

Date: 09/03/2023

Kindly award Certificate and Medals/ Trophies to the following students.

Name of Winner: (In Capital Letters Only)

MONIKA BHOYE

Name of Winner

Branch: B.E CIVIL Year: T.E Mob. No. 9510673705

Name of 1<sup>st</sup> Runner-Up: In Capital Letters Only)

ANJALI BHOJPURHIT

Name of 1<sup>st</sup> Runner-Up

Branch: IT Year: BE Mob. No. 9408592827

Name of 2<sup>nd</sup> Runner-Up: In Capital Letters Only)

HASIYA SHAIKH

Name of 2<sup>nd</sup> Runner-Up

Branch: COMPUTER Year: T.E Mob. No. 8291764966



of Head

*[Signature]*

Received by:

Prof.

P.D Head

PRINCIPAL  
THEEM COLLEGE OF ENGINEERING  
At Village Betegada, Boisar Taluk Road  
Boisar (East) Tal. & Dist. Palghar - 401 501



# List of Winner of Individual Event

Category: Technical/ Sports/ Cultural (Tick any one)

*Traditional*

Date: 10/03/2003

Name of Event: TRADITIONAL DAY

Kindly award Certificate and Medals/ Trophies to the following students.

Name of Winner: (In Capital Letters Only)

H R A D D H A   D E S H M U K H

Name of Winner

Branch: T.E Year: T.E Mob. No. 7058907148

Name of 1<sup>st</sup> Runner-Up: In Capital Letters Only)

P U R V A   C H A U D H A R Y

Name of 1<sup>st</sup> Runner-Up

Branch: CIVIL Year: T.E Mob. No. \_\_\_\_\_

Name of 2<sup>nd</sup> Runner-Up: In Capital Letters Only)

A N I Y A   S H A I K H /   S H A B I S T A   S H A I K H

Name of 2<sup>nd</sup> Runner-Up

Branch: Junior 19<sup>th</sup> (B.E(IT)) Year: - Mob. No. \_\_\_\_\_

of Head

Received by:

*[Signature]*

PRINCIPAL

THEEM COLLEGE OF ENGINEERING  
At Village Betegad, Boisar Chithar Road  
Boisar (East) Tal. & Dist. Palghar - 401 50-



Prof. P.D Head

Boys (Traditional Day)



H. J. THIM TRUST'S  
Theem College of Engineering, Boisar  
Approved by AICTE (New Delhi) Government of Maharashtra & DTE  
Affiliated to University of Mumbai Est.: - 2009 - 2010

# Jashn-e-Theem 2023

## List of Winner of Individual Event

Category: Technical/ Sports/ Cultural (Tick any one)

Date: 10/03/2023

Name of Event: TRADITIONAL DAY

Kindly award Certificate and Medals/ Trophies to the following students.

Name of Winner: (In Capital Letters Only)

DEEPA M RAUT

Name of Winner

Branch: BOMPS Year: B.E Mob. No. \_\_\_\_\_

Name of 1<sup>st</sup> Runner-Up: In Capital Letters Only)

DHRUV PATIL

Name of 1<sup>st</sup> Runner-Up

Branch: 1 Year: F.E Mob. No. \_\_\_\_\_

Name of 2<sup>nd</sup> Runner-Up: In Capital Letters Only)

HIRAG BHOIR

Name of 2<sup>nd</sup> Runner-Up

Branch: \_\_\_\_\_ Year: \_\_\_\_\_ Mob. No. \_\_\_\_\_

(Diploma)

PRINCIPAL  
THEEM COLLEGE OF ENGINEERING  
AL Village Betegad, Boisar Chikhar Road  
Boisar (East) Tal. & Dist. Palghar - 401 501



Prof. Head

Received by:

Prof.

P.D Head



H. J. THIM TRUST'S

## THEEM COLLEGE OF ENGINEERING

### NOTICE

Date: 09/03/2023

All the students are hereby informed that, the college level Cook Without Fire (Boys and Girls) event will be starting from 13<sup>h</sup> March 2023. All the interested students should enroll your name as an Individual or Group on or before 11<sup>rd</sup> March 2023.

(Entry fees for Individual are Rs 10 and for Group /Team is Rs 30.)

Following Coordinators:-

YASHESH PATEL (TE COMP)

JITEN DAS (SE MECH)

MAHEK SHAIKH (SE IT)

FARDEEN ANSARI (TE MECH)

#### Staff Coordinator

Prof. Arbiya Shaikh

Prof. Jayashree

Prof Snehal Patil

#### Cultural Coordinator

Prof. Arbiya Shaikh

Prof. Rosy Bhoi



  
PRINCIPAL  
THEEM COLLEGE OF ENGINEERING  
At, Village Dehagardi, Boisar Ch/Prer Road,  
Boisar (East) Tal. & Dist. Patyitra - 401 50



# JASHN-E-THEEM 2023

## COOK WITHOUT FIRE

13 Mar 2023



**Student Coordinators**  
**Yashesh (TE Comp)**  
**Mahek (SE IT)**

**Staff Coordinators**  
**Prof Arbiya Shaik**  
**Prof Snehal Patil**

**Jiten (SE Mech)**



**Prof Jayashree**

  
**PRINCIPAL**  
THEEM COLLEGE OF ENGINEERING  
At Village Betegada, Borsar Chikhar Road,  
Borsar (East) Tal. & Dist. Palghar - 401 501



H. J. THIM TRUST'S

# Theem College of Engineering, Bolsar

Approved by AICTE (New Delhi) Government of Maharashtra & DTE  
Affiliated to University of Mumbai Est.: - 2009 - 2010

## Jashn-e-Theem 2023

Category: Technical/ Sports/ Cultural (Tick any one)

Date: 13/3/2023

Name of Event: Cook Without Fire

Name of Winner: (In Capital Letters Only)

Type: Intra/Inter

Sr.No	Name	Branch	Year	Mob. No.
1	Jiten Das	B.Mech	B.E	9373474425
2	Yashesh Patel	Mech	B.E	
3				
4				
5				
6				
7				
8				
9				
10				
11				
12				
13				
14				

Head

Received by:

Prof.

P.D Head

PRINCIPAL

THEEM COLLEGE OF ENGINEERING  
At Village Belagad, Bolsar Chikhar Road  
Bolsar (East) Tal. & Dist. Palghar - 401 501





H. J. THIM TRUST'S

# Theem College of Engineering, Boisar

Approved by AICTE (New Delhi) Government of Maharashtra & DTE  
Affiliated to University of Mumbai Est.: - 2009 - 2010

## Jashn-e-Theem 2023

Category: Technical/ Sports/ Cultural (Tick any one)

Date: 13/3/23

Name of Event: Cook without fire

Name of 1<sup>st</sup> Runner-Up: (In Capital Letters Only)

Type: Intra/Inter.

Sr.No	Name	Branch	Year	Mob. No.
1	MAHEK SHAIKH	T.Y Comp	T.Y	7519275867
2	FARDEEN ANSARI	T.Y Comp	T.Y	
3				
4				
5				
6				
7				
8				
9				
10				
11				
12				
13				
14				

Prof.

Head



Received by:

Prof.

P.D Head

*[Signature]*  
PRINCIPAL

THEEM COLLEGE OF ENGINEERING  
AL Village Betegada, Boisar Chithar Road  
Boisar (East) Tal. & Dist. Palghar - 401 50





H. J. THIM TRUST'S

# Theem College of Engineering, Boisar

Approved by AICTE (New Delhi) Government of Maharashtra & DTE.  
Affiliated to University of Mumbai Est.: - 2009 - 2010

## Jashn-e-Theem 2023

Category: Technical/ Sports/ Cultural (Tick any one)

Date: 13/3/23

Name of Event: COOK WITHOUT FIRE

Name of 2<sup>nd</sup> Runner-Up: (In Capital Letters Only)

Type: Intra/Inter

Sr.No	Name	Branch	Year	Mob. No.
1	PRIYANKA BHIDE	T.Y <sub>Comp</sub>	T.Y	8010973391
2				
3				
4				
5				
6				
7				
8				
9				
10				
11				
12				
13				
14				

rof. Head



Received by:

Prof.

P.D Head

PRINCIPAL

THEEM COLLEGE OF ENGINEERING  
AT Village Betegad, Boisar Chithar Road  
Boisar (East) Tal. & Dist. Palghar - 401 501



H. J. THIM TRUST'S

# Theem College of Engineering, Boisar

Approved by AICTE (New Delhi) Government of Maharashtra & DTE  
Affiliated to University of Mumbai Est.: - 2009 - 2010

## Jashn-e-Theem 2023

Category: Technical/ Sports/ Cultural (Tick any one)

Date: 13/3/2023

Name of Event: Cook without fire

Name of Winner: (In Capital Letters Only)

Type: Intra/Inter

Sr.No	Name	Branch	Year	Mob. No.
1	Jiten Das	B.E Mech	B.E	9373474424
2	yeshesh Patel	B.E (M.E)	B.E	
3				
4	Mahek shaikh	T.Y (COMP)	T.Y	7517275867
5	fardeen Ansari	(T.Y) comp	T.Y.	
6				
7	priyanka bhide	(T.Y) comp	T.Y	8010973391
8	Neha sankhe	T.Y (Comp)	T.Y	
9				
10				
11				
12				
13				
14				

Prof. \_\_\_\_\_ Head



Received by:

Prof.

P.D Head

PRINCIPAL

THEEM COLLEGE OF ENGINEERING  
AL Village Betegad, Boisar Chikhar Road  
Boisar (East) Tal. & Dist. Palghar - 401 501



H. J. THIM TRUST'S

## THEEM COLLEGE OF ENGINEERING

### NOTICE

Date: 10/03/2023

All the students are hereby informed that, the college level Solo/Duet/Group Dance (Boys and Girls) events will be starting from 16<sup>th</sup> March 2023. All the interested students should enroll your name as an Individual or Group on or before 13<sup>rd</sup> March 2023.

(Entry fees for Individual are Rs 20 and for Group /Team is Rs 50.)

Following Coordinators:-

SAI APARNA (TE IT)

SHRISHA (SE COMP)

RITIK KHANDARE (SE IT)

YASH PRAKASH (TE MECH)

#### Staff Coordinator

Prof. Jagruti More

Prof. Monika Pathare

Prof Snehal Patil

#### Cultural Coordinator

Prof. Arbiya Shaikh

Prof. Rosy Bhoi



  
- PRINCIPAL  
THEEM COLLEGE OF ENGINEERING  
AL Village Betegada, Borsar Chikhar Road  
Borsar (East) Tal. & Dist. Palghar - 401 501



# ASHN-E-THEEM 2023

Kalanjali 2.0

# DANCE

## COMPETITION

tion :  
**Feb**  
Round :  
**Feb**  
Round :  
**Feb**

Ordinator  
al Patil  
ha Bari  
a Raut



Student Co Ordina  
**Sufiya Shaik**  
996719538  
**Shreya Mishr**  
937289389  
**Haider**  
814976499  
**Prachiti Pati**  
706610145  
**Prathmesh Pa**  
920909609  
**Vaishnav Gawa**  
997018660

## Solo | Duet | Group

## On 15th March 2023

**Registration For The First Round Registration Is Compulsory**

Held At Auditorium Second Floor Degree Building | At - 02:00 p





H. J. THIM TRUST'S  
**Theem College of Engineering, Boisar**

Approved by AICTE (New Delhi) Government of Maharashtra & DTE  
 Affiliated to University of Mumbai Est.: - 2009 - 2010

# Jashn-e-Theem 2023

## List of Winner of Individual Event

Category: Technical/ Sports/ Cultural (Tick any one)

Date: 16/03/2023

Name of Event: Dance

Kindly award Certificate and Medals/ Trophies to the following students.

Name of Winner: (In Capital Letters Only)

SAI APARNA MAHENDRA POOTARI

Name of Winner

Branch: Ai & ml Year: SE Mob. No. 9167483769

Name of 1<sup>st</sup> Runner-Up: In Capital Letters Only

VASH JOGE PRAKASH

Name of 1<sup>st</sup> Runner-Up

Branch: ELECT Year: TY Mob. No. 8999033278

Name of 2<sup>nd</sup> Runner-Up: In Capital Letters Only

HUBHAM KADAM

Name of 2<sup>nd</sup> Runner-Up

Branch: MECH Year: BE Mob. No. 9936016009



*[Signature]*  
 PRINCIPAL  
 THEEM COLLEGE OF ENGINEERING  
 At Village Betegaon, Boisar Chitthar Road  
 Boisar (East) Tal. & Dist. Palghar - 401 501

Prof. Head

Received by:

Prof.

P.D Head



H. J. THIM TRUST'S

# Theem College of Engineering, Boisar

Approved by AICTE (New Delhi) Government of Maharashtra & DTE  
Affiliated to University of Mumbai Est.: - 2009 - 2010

## Jashn-e-Theem 2023

Category: Technical/ Sports/ Cultural (Tick any one)

Name of Event: Duet (Dance)

Date: 16/03/2023

Name of Winner: (In Capital Letters Only)

Type: Intra/Inter

Sr.No	Name	Branch	Year	Mob. No.
1	Aasiya Shaikh	TE-comp	TE	8291764966
2	Aniket more	mech	BE	9082447082
3				
4				
5				
6				
7				
8				
9				
10				
11				
12				
13				
14				

of

Head

*[Signature]*  
PRINCIPAL

Received by:

Prof.

P.D Head



THEEM COLLEGE OF ENGINEERING  
At Village Betegada, Boisar Chikhar Road,  
Boisar (East) Tal. & Dist. Palghar - 401 501





H. J. THIM TRUST'S

# Theem College of Engineering, Boisar

Approved by AICTE (New Delhi) Government of Maharashtra & DTE  
Affiliated to University of Mumbai Est.: - 2009 - 2010

## Jashn-e-Theem 2023

Category: Technical/ Sports/ Cultural (Tick any one)

Date: 16/03/2023

Name of Event: Group Dance

Name of Winner: (In Capital Letters Only)

Type: Intra/Inter

Sr.No	Name	Branch	Year	Mob. No.
1	SHRISHA SHETTY	EXTC	BE	9518994502
2	MANASVEE DOIPHODE	EXTC	BE	
3	AASIYA SHAIKH	COMP	TE	8291764966
4	SHUBHAM KADAM	MECH	BE	9930016009
5	ANIKET MORE	MECH	BE	
6	VAIBHAV RASAL	MECH	TE	
7				
8				
9				
10				
11				
12				
13				
14				

Head

PRINCIPAL

THEEM COLLEGE OF ENGINEERING  
AL Village Betegad, Boisar Chitthar Road  
Boisar (East) Tal. & Dist. Palghar - 401 501

Received by:

Prof.

P.D Head





H. J. THIM TRUST'S

# Theem College of Engineering, Boisar

Approved by AICTE (New Delhi) Government of Maharashtra & DTE  
Affiliated to University of Mumbai Est.: - 2009 - 2010

## Jashn-e-Theem 2023

Category: Technical/ Sports/ Cultural (Tick any one)

Date: 16/03/2023

Name of Event: Group dance

Name of 1<sup>st</sup> Runner-Up: (In Capital Letters Only)

Type: Intra/Inter

Sl. No.	Name	Branch	Year	Mob. No.
1	AASIYA SHAIKH	TE-com	TE	
2	MANSI PATHARE	Aifm	TE	
3	AISHWARYA GOLATKER	Comp	TE	
4	SUPIYA SHAIKH	Aifml	TE	
5	JANHVI MAHATRE	Comp	TE	
6	KOMAL SIDDHART	Aifml	SE	
7	SAKSHI WAGHAMARE	Comp	SE	
8	SHRUTA THAKUR	Comp	TE	
9				
10				
11				
12				
13				
14				

Head



Received by:

Prof.

P.D Head

PRINCIPAL

THEEM COLLEGE OF ENGINEERING,  
At Village Betegad, Boisar Chikhar, Road  
Boisar (East) Tal. & Dist. Patghar - 401 50



H. J. THIM TRUST'S

# Theem College of Engineering, Boisar

Approved by AICTE (New Delhi) Government of Maharashtra & DTE  
Affiliated to University of Mumbai Est.: - 2009 - 2010

## Jashn-e-Theem 2023

Category: Technical/ Sports/ Cultural (any one)

Date: 6/03/2023

Name of Event: Group Dance

Name of 2<sup>nd</sup> Runner-Up: (In Capital Letters Only)

Type: Intra/Inter

Sr.No	Name	Branch	Year	Mob. No.
1	JEET GORE	IT	TE	8390735851
2	MEET TODANKAR	IT	TE	
3	DEEPAK BISHTA	IT	TE	
4	CHINMAY PATIL	IT	TE	
5	HARSH GHARAT	IT	TE	
6	YUVRAJ SHARMA	IT	TE	
7	ADITYA GUPTA	IT	TE	
8	RISHU VERMA	IT	TE	
9	PRANAY PARPE	IT	TE	
10	RUGVED PATIL	IT	TE	7391805407
11	ARCHIS SAVE	IT	TE	
12				
13				
14				

Head

PRINCIPAL

THEEM COLLEGE OF ENGINEERING  
AL, Village Betogach, Boisar Chikhar Road,  
Boisar (East) Tal. & Dist. Palghar - 401 50

Received by:

Prof.

P.D Head







# H. J. THIM TRUST'S THEEM COLLEGE OF ENGINEERING

Approved by AICTE (New Delhi), Government of Maharashtra & DTE, Affiliated to University of Mumbai & MSBTE, Estd. 2009  
A NAAC Accredited Institute | Institute Code: EN3222

## Certificate

This certificate is awarded to

Mr./Ms. BHAVIK NIJAI of B.E (IT)

for Co-ordinating / Participating / Securing WINNER in the event of  
TUG OF WAR at **JASHN-E-THEEM** on 15<sup>th</sup> MARCH, 2023



Harshad

Event Co-ordinator

[Signature]

PRINCIPAL

THEEM COLLEGE OF ENGINEERING  
AL Village Betegadi, Bolisar Chikhar Road,  
Bolisar (East) Tal. & Dist. Palghar - 401 50.

[Signature]

Principal





# H. J. THIM TRUST'S THEEM COLLEGE OF ENGINEERING

(New Delhi), Government of Maharashtra & DTE, Affiliated to University of Mumbai & MSBTE, Estd. 2009  
A NAAC Accredited Institute | Institute Code: EN3222

## Certificate

This certificate is awarded to  
Mr./Ms. ANKUR JADHAV of B.E (IT)  
for Co-ordinating / Participating / Securing FIRST RUNNER - UP in the event of  
ROBO RACE (INTRA) at **JASHN-E-THEEM** on 14<sup>th</sup> MARCH, 2023

  
\_\_\_\_\_  
Event Co-ordinator

  
\_\_\_\_\_  
PRINCIPAL  
THEEM COLLEGE OF ENGINEERING  
At Village Betegaon, Boisar Chithar Road  
Boisar (East) Tal. & Dist. Palghar - 401 501



  
\_\_\_\_\_  
Principal





# H. J. THIM TRUST'S THEEM COLLEGE OF ENGINEERING

Approved by AICTE (New Delhi), Government of Maharashtra & DTE, Affiliated to University of Mumbai & MSBTE, Estd. 2009  
A NAAC Accredited Institute | Institute Code: EN3222

## Certificate

This certificate is awarded to

Mr./Ms. NAVIN CHUDASAMA of S.E (AIML)

for Co-ordinating / Participating / Securing FIRST RUNNER UP in the event of  
BOLLYWOOD DAY at **JASHN-E-THEEM** on 9<sup>th</sup> MARCH, 2023



Event Co-ordinator

PRINCIPAL  
THEEM COLLEGE OF ENGINEERING  
AL Village Betegaon, Boisar Chilhar Road,  
Boisar (East) Tal. & Dist. Palghar - 401 501

Principal





# H. J. THIM TRUST'S THEEM COLLEGE OF ENGINEERING

Approved by AICTE (New Delhi), Government of Maharashtra & DTE, Affiliated to University of Mumbai & MSBTE, Estd. 2009  
A NAAC Accredited Institute | Institute Code: EN3222

## Certificate

*This certificate is awarded to*

**Mr./Ms. MUHIBBURRAHMAN** of **B.E. (COMPS)**

*for Co-ordinating / Participating / Securing* **FIRST RUNNER-UP** *in the event of*  
**CODE BREAKER** *at* **JASHN-E-THEEM** *on* **15<sup>th</sup> MARCH, 2023**



Event Co-ordinator

PRINCIPAL  
THEEM COLLEGE OF ENGINEERING  
At Village Betegaon, Boisar Chilhar Road,  
Boisar (East) Tal. & Dist. Palghar - 401 501

Principal

Village Betegaon, Boisar Chilhar Road, Boisar (E), Tal. & Dist. Palghar - 401 501. | Office: 7769916109 | Admission: 7506830077



# H. J. THIM TRUST'S THEEM COLLEGE OF ENGINEERING

Approved by AICTE (New Delhi), Government of Maharashtra & DTE, Affiliated to University of Mumbai & MSBTE, Estd. 2009  
A NAAC Accredited Institute | Institute Code: EN3222

## Certificate

*This certificate is awarded to*

Mr./Ms. MVHIBBURRAHMAN ATEEQUE AHMED of B.E. (COMP)

*for Co-ordinating / Participating / Securing* \_\_\_\_\_ *in the event of*

BREAK THE QUARTY at **JASHN-E-THEEM** on 16-03-2023



Event Co-ordinator

PRINCIPAL  
THEEM COLLEGE OF ENGINEERING  
At Village Betegaon, Boisar Chilar Road,  
Boisar (East), Tal. & Dist. Palghar - 401 501

Principal





# H. J. THIM TRUST'S THEEM COLLEGE OF ENGINEERING

Approved by AICTE (New Delhi), Government of Maharashtra & DTE, Affiliated to University of Mumbai & MSBTE, Estd. 2009  
A NAAC Accredited Institute | Institute Code: EN3222

## Certificate

This certificate is awarded to

Mr./Ms. MUHIBBUREHMAN ATIK AHMED of B.E (COMPUTER)

for Co-ordinating / Participating / Securing RUNNER UP in the event of

TUG OF WAR at **JASHN-E-THEEM** on 15<sup>th</sup> MARCH, 2023



*Haresh*

Event Co-ordinator

*[Signature]*  
PRINCIPAL  
THEEM COLLEGE OF ENGINEERING  
AL Village Betegaon, Boisar 401501  
Maharashtra Tel. & Dist. Palghar - 401 501

*[Signature]*

Principal

Village Betegaon, Boisar Chlhar Road, Boisar (E), Tal. & Dist. Palghar - 401 501. | Office: 7769916109 | Admission: 7506830077





# H. J. THIM TRUST'S THEEM COLLEGE OF ENGINEERING

Approved by AICTE (New Delhi), Government of Maharashtra & DTE, Affiliated to University of Mumbai & MSBTE, Estd. 2009  
A NAAC Accredited Institute | Institute Code: EN3222

## Certificate

This certificate is awarded to

Mr./Ms. MUNISBURRAHMAN ATEEQUE AHMED of B.E (COMP)

for Co-ordinating / Participating / Securing WINNER in the event of

LOGICAL QUIZ at **JASHN-E-THEEM** on 16/03/2023



  
Event Co-ordinator

  
PRINCIPAL  
THEEM COLLEGE OF ENGINEERING  
AL Village Betegaon, Boisar Chilhar Road,  
Boisar (East) Tal. & Dist. Palghar - 401 501

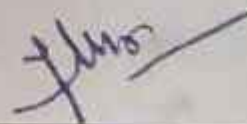
  
Principal

Village Betegaon, Boisar Chilhar Road, Boisar (E), Tal. & Dist. Palghar - 401 501. | Office: 7769916109 | Admission: 7506830077



H. J. THIM TRUST'S  
**THEEM COLLEGE OF ENGINEERING**

Approved by AICTE (New Delhi), Government of Maharashtra & DTE, Affiliated to University of Mumbai & MSBTE, Estd. 2009  
A NAAC Accredited Institute | Institute Code: EN3222

# Certificate

This certificate is awarded to

Mr./Ms. RACHAL YADAV of T.E(CIT)

for Co-ordinating / Participating / Securing SECOND RUNNER-UP in the event of  
GROUP DAY at **JASHN-E-THEEM** on 08<sup>th</sup> MARCH, 2023

  
Event Co-ordinator

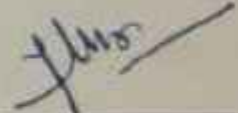
  
Principal

Village Betegaon, Boisar Chilhar Road, Boisar (E), Tal. & Dist. Palghar - 401 501. | Office: 7769916109 | Admission: 7506830077



  
PRINCIPAL  
THEEM COLLEGE OF ENGINEERING  
At Village Betegaon, Boisar Chilhar Road,  
Boisar (East) Tal. & Dist. Palghar - 401 501



F. J. THIMMEST'S  
**THEEM COLLEGE OF ENGINEERING**

Approved by AICTE (New Delhi), Government of Maharashtra & OTE, Affiliated to University of Mumbai & MSITE, Estd. 2009  
A NAAC Accredited Institute | Institute Code: EN3222

# Certificate

This certificate is awarded to

Mr/Ms. HARSHIT SINGH

of SE - AIML

for Co-ordinating / Participating / Securing DISCIPLINE COMMITTEE in the event of  
at JASHN-E-THEEM on 13<sup>th</sup> to 17<sup>th</sup> MARCH, 2023

Event Co-ordinator

Principal

Village Betegaon, Boisar Chihar Road, Boisar (E), Tal. & Dist. Palghar - 401 501. | Office: 7769916109 | Admission: 7506830077



PRINCIPAL  
THEEM COLLEGE OF ENGINEERING  
At Village Betegaon, Boisar Chihar Road,  
Boisar (East) Tal. & Dist. Palghar - 401 501





# H. J. THIM TRUST'S THEEM COLLEGE OF ENGINEERING

Approved by AICTE (New Delhi), Government of Maharashtra & DTE, Affiliated to University of Mumbai & MSBTE, Estd. 2009  
A NAAC Accredited Institute | Institute Code: EN3222

## Certificate

*This certificate is awarded to*

**Mr./Ms. VISHWAKARMA SAURABH** of **B.E. (COMPS)**

for *Co-ordinating / Participating / Securing* **WINNER** in the event of

**CODE BREAKER** at **JASHN-E-THEEM** on **15<sup>th</sup> March, 2023**

Event Co-ordinator

PRINCIPAL  
THEEM COLLEGE OF ENGINEERING  
At Village Betegaon, Boisar Chilhar Road  
Boisar (East) Tal. & Dist. Palghar - 401 501

Principal





H. J. THIM TRUST'S  
**THEEM COLLEGE OF ENGINEERING**

Approved by AICTE (New Delhi), Government of Maharashtra & DTE, Affiliated to University of Mumbai & MSBTE, Estd. 2009  
A NAAC Accredited Institute | Institute Code: EN0222

## Certificate

This certificate is awarded to

Mr./Ms. RIZWAN KHAN of B.E (IT)

for Co-ordinating / Participating / Securing WINNER in the event of  
TUG OF WAR at **JASHN-E-THEEM** on 15<sup>th</sup> MARCH, 2023

  
Event Co-ordinator

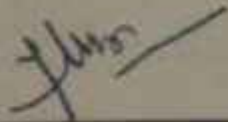
  
Principal

Village Betegaon, Boisar Chithar Road, Boisar (E), Tal. & Dist. Palghar - 401 501. | Office: 7769916109 | Admission: 7506830077



  
- PRINCIPAL  
THEEM COLLEGE OF ENGINEERING  
At Village Betegaon, Boisar Chithar Road,  
Boisar (East) Tal. & Dist. Palghar - 401 501





# H. J. THIM TRUST'S THEEM COLLEGE OF ENGINEERING

Approved by AICTE (New Delhi), Government of Maharashtra & DTE, Affiliated to University of Mumbai & MSBTE, Estd. 2009  
A NAAC Accredited Institute | Institute Code: EN3222

## Certificate

*This certificate is awarded to*

*Mr./Ms. TEJAL VISHNU LAHANGE* of *T.E (LIVEL)*

*for Co-ordinating / Participating / Securing* **WINNER** *in the event of*

*TOWN PLANNING* at **JASHN-E-THEEM** on *13<sup>th</sup> MARCH, 2023*

Event Co-ordinator



PRINCIPAL

THEEM COLLEGE OF ENGINEERING  
At Village Betegaon, Boisar Chilhar Road,  
Boisar (East) Tal. & Dist. Palghar - 401 501

Principal





# H. J. THIM TRUST'S THEEM COLLEGE OF ENGINEERING

Approved by AICTE (New Delhi), Government of Maharashtra & DTE, Affiliated to University of Mumbai & MSBTE, Estd. 2009  
A NAAC Accredited Institute | Institute Code: EN3222

## Certificate

*This certificate is awarded to*

*Mr./Ms.* MONIKA BHOYE of B.E (CIVIL)

*for Co-ordinating / Participating / Securing* WINNER *in the event of*

BOLLYWOOD DAY at **JASHN-E-THEEM** on 9<sup>th</sup> MARCH, 2023



*[Signature]*  
Event Co-ordinator



*[Signature]*  
Principal



H. J. THIM TRUST'S  
**THEEM COLLEGE OF ENGINEERING**

Approved by AICTE (New Delhi), Government of Maharashtra & JTE, Affiliated to University of Mumbai & MSBTE, Esid. 2009  
A NAAC Accredited Institute | Institute Code: EN3222

# Certificate

*This certificate is awarded to*

Mr./Ms. ADITYA GUPTA

*of* TEC(IT)

*for Co-ordinating / Participating / Securing* SECOND RUNNER-UP *in the event of*  
GROUP DANCE *at* JASHN-E-THEEM *on* 15<sup>th</sup> MARCH, 2023

Event Co-ordinator

Principal

Village Betegaon, Bolsar Chilhar Road, Bolsar (E), Tal. & Dist. Palghar - 401 501. | Office: 7769916109 | Admission: 7506830077



PRINCIPAL  
THEEM COLLEGE OF ENGINEERING  
At Village Betegaon, Bolsar Chilhar Road,  
Bolsar (East) Tal. & Dist. Palghar - 401 501





H. J. THIM TRUST'S  
**THEEM COLLEGE OF ENGINEERING**

Approved by AICTE (New Delhi), Government of Maharashtra & DTE, Affiliated to University of Mumbai & MSBTE, Estd. 2009  
A NAAC Accredited Institute | Institute Code: EN3222

# Certificate

This certificate is awarded to

Mr/Ms. ADITYA GUPTA

of TE (IT)

for Co-ordinating / Participating / Securing SECOND RUNNER-UP in the event of  
GROUP DAY at **JASHN-E-THEEM** on 08<sup>th</sup> MARCH, 2023

Event Co-ordinator

Principal

Village Betegaon, Boisar Chihar Road, Boisar (E), Tal. & Dist. Palghar - 401 501. | Office: 7769916109 | Admissions: 7506830077



PRINCIPAL

THEEM COLLEGE OF ENGINEERING  
At, Village Betegaon, Boisar Chihar Road  
Boisar (E) Tal. & Dist. Palghar - 401 501





# H. J. THIM TRUST'S THEEM COLLEGE OF ENGINEERING

Approved by AICTE (New Delhi), Government of Maharashtra & DTE, Affiliated to University of Mumbai & MSBTE, Estd. 2009  
A NAAC Accredited Institute | Institute Code: IN3222

## Certificate

This certificate is awarded to

Mr./Ms. ADITYA GUPTA of T.E (IT)

for Co-ordinating / Participating / Securing SECOND RUNNER UP in the event of  
BADMINTON (DOUBLES) at **JASHN-E-THEEM** on 14<sup>th</sup> MARCH, 2023

Haresh  
Event Co-ordinator

[Signature]  
Principal

Village Betegaon, Boisar Chilhar Road, Boisar (E), Tal. & Dist. Palghar - 401 501. | Office: 7769916109 | Admission: 7506830077



[Signature]  
- PRINCIPAL  
THEEM COLLEGE OF ENGINEERING  
At Village Betegaon, Boisar Chilhar Road,  
Boisar (East) Tal. & Dist. Palghar - 401 501





# H. J. THIM TRUST'S THEEM COLLEGE OF ENGINEERING

Approved by AICTE (New Delhi), Government of Maharashtra & DTE, Affiliated to University of Mumbai & MSBTE, Estd. 2009  
A NAAC Accredited Institute | Institute Code: EN3222

## Certificate

*This certificate is awarded to*

*Mr./Ms. JANNAT SHAIKH* of *B.E. (COMPUTER)*

*for Co-ordinating / Participating / Securing* **FIRST RUNNER-UP** *in the event of*  
**BEST OUT OF WASTE** *at* **JASHN-E-THEEM** *on* **16. MARCH, 2023**

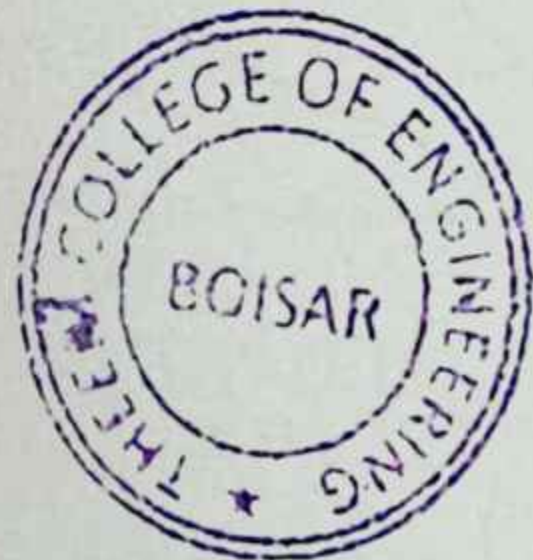

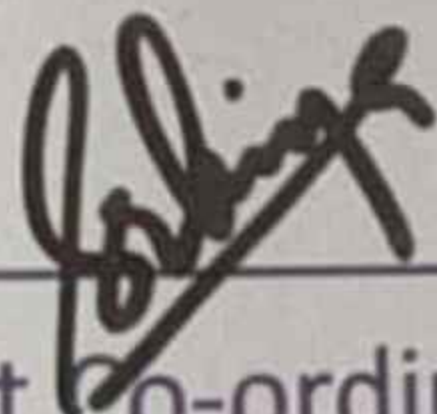
  
Event Co-ordinator

  
PRINCIPAL  
THEEM COLLEGE OF ENGINEERING  
At Village Betegaon, Boisar Chilhar Road,  
Boisar (East) Tal. & Dist. Palghar - 401 501

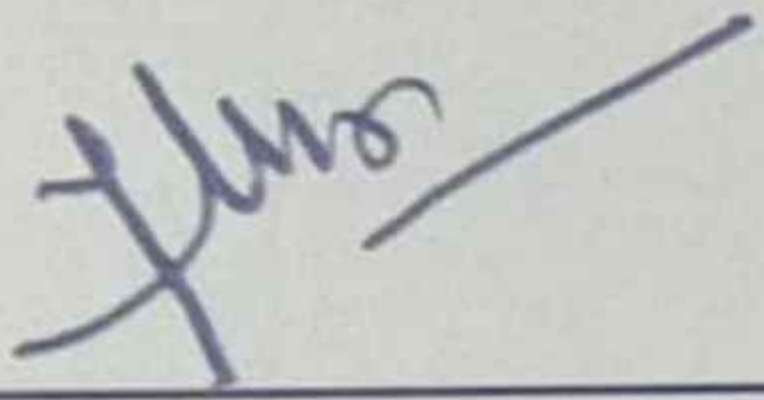
  
Principal





H. J. THIM TRUST'S  
**THEEM COLLEGE OF ENGINEERING**

Approved by AICTE (New Delhi), Government of Maharashtra & DTE, Affiliated to University of Mumbai & MSBTE, Estd. 2009  
A NAAC Accredited Institute | Institute Code: EN3222

# Certificate

*This certificate is awarded to*

*Mr./Ms. JANNAT SHAIKH* of *BE (COMPUTER)*

*for Co-ordinating / Participating / Securing* **SECOND RUNNER-UP** *in the event of*  
**BOAT CHALLENGE** *at* **JASHN-E-THEEM** *on* **13<sup>th</sup> MARCH '2023**



Event Co-ordinator

PRINCIPAL

THEEM COLLEGE OF ENGINEERING  
At Village Betegaon, Boisar Chilhar Road,  
Boisar (East) Tal. & Dist. Palghar - 401 501

Principal





H. J. THIM TRUST'S  
**THEEM COLLEGE OF ENGINEERING**

Approved by AICTE (New Delhi), Government of Maharashtra & DTE, Affiliated to University of Mumbai & MSBTE, Estd. 2009  
A NAAC Accredited Institute | Institute Code: EN3222

# Certificate

*This certificate is awarded to*

*Mr./Ms. SHAIKH JANNAT* of *B.E. (COMPUTER)*

*for Co-ordinating / Participating / Securing* WINNER *in the event of*

*MEHENDI COMPETITION* at **JASHN-E-THEEM** on 15<sup>th</sup> MARCH, 2023

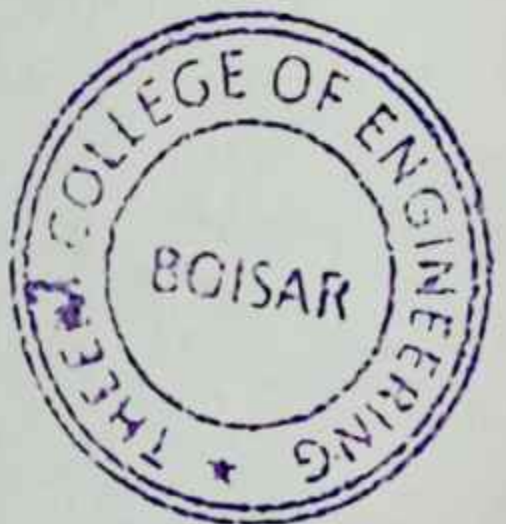

*[Signature]*  
Event Co-ordinator

*[Signature]*  
PRINCIPAL  
THEEM COLLEGE OF ENGINEERING  
At Village Betegaon, Boisar Chilhar Road  
Boisar (East) Tal. & Dist. Palghar - 401 501

*[Signature]*  
Principal





H. J. THIM TRUST'S  
**THEEM COLLEGE OF ENGINEERING**

Approved by AICTE (New Delhi), Government of Maharashtra & DTE, Affiliated to University of Mumbai & MSBTE, Estd. 2009  
A NAAC Accredited Institute | Institute Code: EN3222

# Certificate

This certificate is awarded to

Mr./Ms. ABHAY SINGH of B.E (COMPUTER) THEEM

for Co-ordinating / Participating / Securing in the event of

WEBATHON (INTRA) at JASHN-E-THEEM on 16<sup>th</sup> MARCH, 2023



  
\_\_\_\_\_  
Event Co-ordinator

  
\_\_\_\_\_  
PRINCIPAL  
THEEM COLLEGE OF ENGINEERING  
AL Village Betegaon, Boisar Chilhar Road,  
Boisar (East) Tal. & Dist. Palghar - 401 501

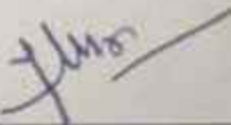
  
\_\_\_\_\_  
Principal



# H. J. THIM TRUST'S THEEM COLLEGE OF ENGINEERING

Approved by AICTE (New Delhi), Government of Maharashtra & DTE, Affiliated to University of Mumbai & MSBTE, Estd. 2009  
A NAAC Accredited Institute | Institute Code: EN3222

## Certificate

This certificate is awarded to

Mr./Ms. ABHAY AJAY SINGH of B.E (COMPUTER)

for Co-ordinating / Participating / Securing SECOND RUNNER UP in the event of  
PROGRAMMING QUIZ at JASHN-E-THEEM on 14 MARCH, 2023



Event Co-ordinator

PRINCIPAL

THEEM COLLEGE OF ENGINEERING  
At Village Betegaon, Boisar Chilhar Road,  
Boisar (East) Tal. & Dist. Palghar - 401 501

Principal





H. J. THIM TRUST'S  
**THEEM COLLEGE OF ENGINEERING**

Approved by AICTE (New Delhi), Government of Maharashtra & DTE, Affiliated to University of Mumbai & MSBTE, Estd. 2009  
A NAAC Accredited Institute | Institute Code: EN3222

# Certificate

*This certificate is awarded to*

Mr/Ms. ABHAY AJAY SINGH of B.E (COMPUTER)

for Co-ordinating / Participating / Securing WINNER in the event of

BRIDGE DESIGN COMPETITION at JASHN-E-THEEM on 14<sup>th</sup> MARCH, 2023



  
\_\_\_\_\_  
Event Co-ordinator

  
\_\_\_\_\_  
PRINCIPAL  
THEEM COLLEGE OF ENGINEERING  
At Village Betegaon, Boisar Chilhar Road  
Boisar (East) Tal. & Dist. Palghar - 401 501

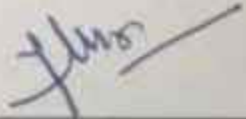
  
\_\_\_\_\_  
Principal



H. J. THIM TRUST'S  
**THEEM COLLEGE OF ENGINEERING**

Approved by AICTE (New Delhi), Government of Maharashtra & DTE, Affiliated to University of Mumbai & MSBTE, Estd. 2009  
A NAAC Accredited Institute | Institute Code: EN3222

# Certificate

This certificate is awarded to

Mr./Ms. Singh Abhay Ajay of BE COMP

for Co-ordinating / Participating / Securing Singing in the event of

Culture at **JASHN-E-THEEM** on 16/03/2023



[Signature]  
Event Co-ordinator

[Signature]  
PRINCIPAL  
THEEM COLLEGE OF ENGINEERING  
At Village Betegaon, Boisar Chilhhar Road,  
Boisar (East) Tal. & Dist. Palghar - 401 501

[Signature]  
Principal





H. J. THIM TRUST'S  
**THEEM COLLEGE OF ENGINEERING**

Approved by AICTE (New Delhi), Government of Maharashtra & DTE, Affiliated to University of Mumbai & MSBTE, Estd. 2009  
A NAAC Accredited Institute | Institute Code: EN3222

## Certificate

This certificate is awarded to

Mr./Ms. ABHISHA GHARAT of T.E. [COMPUTER]

for Co-ordinating / Participating / Securing \_\_\_\_\_ in the event of

RAW at **JASHN-E-THEEM** on 13<sup>th</sup> MARCH, 2023

Event Co-ordinator

PRINCIPAL

THEEM COLLEGE OF ENGINEERING,  
At Village Betegaon, Bolsar Chilhar Road,  
Bolsar (East) Tal. & Dist. Palghar - 401 501



Principal

Village Betegaon, Bolsar Chilhar Road, Bolsar (E), Tal. & Dist. Palghar - 401 501. | Office: 7769916109 | Admission: 7506830077



H. J. THIM TRUST'S  
**THEEM COLLEGE OF ENGINEERING**

Approved by AICTE (New Delhi), Government of Maharashtra & DTE, Affiliated to University of Mumbai & MSBTE, Estd. 2009  
A NAAC Accredited Institute | Institute Code: EN3222

# Certificate

This certificate is awarded to

Mr./Ms. Chandramohan Thakur of T.E AIML

for Co-ordinating / Participating / Secyring \_\_\_\_\_ in the event of  
Webathon at **JASHN-E-THEEM** on 16th March 2023

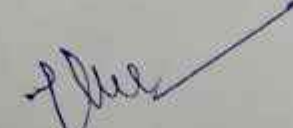

  
\_\_\_\_\_  
Event Co-ordinator

  
\_\_\_\_\_  
PRINCIPAL  
THEEM COLLEGE OF ENGINEERING  
At Village Betegaon, Bolisar Chilhar Road,  
Bolisar (East) Tal. & Dist. Palghar - 401 501

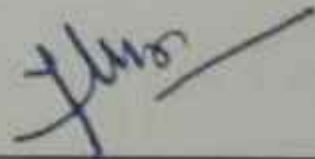
  
\_\_\_\_\_  
Principal





# H. J. THIM TRUST'S THEEM COLLEGE OF ENGINEERING

Approved by AICTE (New Delhi), Government of Maharashtra & DTE, Affiliated to University of Mumbai & MSBTE, Estd. 2009  
A NAAC Accredited Institute | Institute Code: EN3222

## Certificate

*This certificate is awarded to*

Mr./Ms. Chandramohan Thakur of TE CAIML

*for Co-ordinating / Participating / Securing* \_\_\_\_\_ *in the event of*

Robo Race at **JASHN-E-THEEM** on 14<sup>th</sup> March 2023

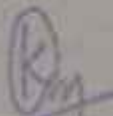

  
\_\_\_\_\_  
Event Co-ordinator

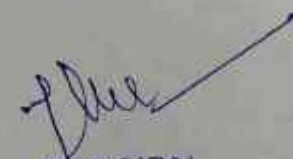
  
\_\_\_\_\_  
PRINCIPAL  
THEEM COLLEGE OF ENGINEERING  
At Village Betegaon, Boisar Chilhar Road,  
Boisar (East) Tal. & Dist. Palghar - 401 501

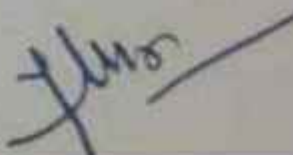
  
\_\_\_\_\_  
Principal



H. J. THIM TRUST'S  
**THEEM COLLEGE OF ENGINEERING**

Approved by AICTE (New Delhi), Government of Maharashtra & DTE, Affiliated to University of Mumbai & MSBTE, Estd. 2009  
A NAAC Accredited Institute | Institute Code: EN3222

## Certificate

*This certificate is awarded to*

Mr./Ms. IRAM FATEMA ANSARI of T.E (COMPUTER)

for Co-ordinating / Participating / Securing WINNER in the event of  
PROGRAMMING QUIZ at **JASHN-E-THEEM** on 14 MARCH, 2023

Event Co-ordinator

Principal

Village Betegaon, Boisar Chilhar Road, Boisar (E), Tal. & Dist. Paighar - 401 501. | Office: 7769916109 | Admission: 7506830077



  
- PRINCIPAL  
THEEM COLLEGE OF ENGINEERING  
At Village Betegaon, Boisar Chilhar Road,  
Boisar (East) Tal. & Dist. Paighar - 401 501





H. J. THIM TRUST'S  
**THEEM COLLEGE OF ENGINEERING**

Approved by AICTE (New Delhi), Government of Maharashtra & DTE, Affiliated to University of Mumbai & MSBTE, Estd. 2009  
A NAAC Accredited Institute | Institute Code: EN3222

## Certificate

*This certificate is awarded to*

*Mr./Ms.* ANSARI IRAM *of* T.E. (COMPUTER)

*for Co-ordinating / Participating / Securing* SECOND RUNNER-UP *in the event of*  
MEHENDI COMPETITION *at* **JASHN-E-THEEM** *on* 15<sup>th</sup> MARCH, 2023

  
Event Co-ordinator

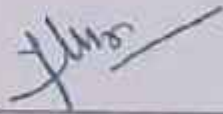
  
Principal

Village Betegaon, Boisar Chilhar Road, Boisar (E), Tal. & Dist. Palghar - 401 501. | Office: 7769916109 | Admission: 7506830077



  
PRINCIPAL  
THEEM COLLEGE OF ENGINEERING  
At Village Betegaon, Boisar Chilhar Road,  
Boisar (East) Tal. & Dist. Palghar - 401 501



H. J. THIM TRUST'S  
**THEEM COLLEGE OF ENGINEERING**

Approved by AICTE (New Delhi), Government of Maharashtra & DTE, Affiliated to University of Mumbai & MSBTE, Estd. 2009  
A NAAC Accredited Institute | Institute Code: EN3222

# Certificate

This certificate is awarded to

Mr./Ms. VINAYAK PANDEY of S.E. [AIML]

for Co-ordinating / Participating / Securing \_\_\_\_\_ in the event of  
RAW at **JASHN-E-THEEM** on 13<sup>th</sup> MARCH, 2023

Event Co-ordinator

Principal

Village Betegaon, Boisar Chilhar Road, Boisar (E), Tal. & Dist. Palghar - 401 501. | Office: 7769916109 | Admission: 7506830077



PRINCIPAL

THEEM COLLEGE OF ENGINEERING  
AL Village Betegaon, Boisar Chilhar Road,  
Boisar (East) Tal. & Dist. Palghar - 401 501





H. J. THIM TRUST'S  
**THEEM COLLEGE OF ENGINEERING**

Approved by AICTE (New Delhi), Government of Maharashtra & DTE, Affiliated to University of Mumbai & MSBTE, Estd. 2009  
A NAAC Accredited Institute | Institute Code: EN3222

# Certificate

This certificate is awarded to

Mr./Ms. VINAYAK PANDEY of S.E (AIML)

for Co-ordinating / Participating / Securing WINNER in the event of

ROBO RACE (INTER) at **JASHN-E-THEEM** on 14<sup>th</sup> MARCH, 2023

Event Co-ordinator

Principal

Village Betegaon, Boisar Chilhar Road, Boisar (E), Tal. & Dist. Palghar - 401 501. | Office: 7769916109 | Admission: 7506830077



PRINCIPAL  
THEEM COLLEGE OF ENGINEERING  
At: Village Betegaon, Boisar Chilhar Road,  
Boisar (East) Tal. & Dist. Palghar - 401 501



H. J. THIM TRUST'S  
**THEEM COLLEGE OF ENGINEERING**

Approved by AICTE (New Delhi), Government of Maharashtra & DTE, Affiliated to University of Mumbai & MSBTE, Estd. 2009  
A NAAC Accredited Institute | Institute Code: EN3222

# Certificate

This certificate is awarded to

Mr./Ms. Vinayak J. Pandey of S.E (AIML)

for Co-ordinating / Participating / Securing 1st Runner UP in the event of  
Auto-Quiz at **JASHN-E-THEEM** on 16th March 2023

Event Co-ordinator

Principal

Village Betegaon, Boisar Chilhar Road, Boisar (E), Tal. & Dist. Palghar - 401 501. | Office: 7769916109 | Admission: 7506830077



PRINCIPAL  
THEEM COLLEGE OF ENGINEERING  
AL Village Betegaon, Boisar Chilhar Road  
Boisar (East) Tal. & Dist. Palghar - 401 501



# H. J. THIM TRUST'S THEEM COLLEGE OF ENGINEERING

Approved by AICTE (New Delhi), Government of Maharashtra & DTE, Affiliated to University of Mumbai & MSBTE, Estd. 2009  
A NAAC Accredited Institute | Institute Code: EN3222

## Certificate

*This certificate is awarded to*

Mr./Ms. PATIL KANAD SANJAY of BE (IT)

for *Co-ordinating / Participating / Securing* WINNER in the event of

LOGO MAKING at **JASHN-E-THEEM** on 9<sup>th</sup> MARCH, 2023



Event Co-ordinator

PRINCIPAL  
THEEM COLLEGE OF ENGINEERING  
At Village Betegaon, Boisar Chilhar Road  
Boisar (East) Tal. & Dist. Palghar - 401 501

Principal







# H. J. THIM TRUST'S THEEM COLLEGE OF ENGINEERING

Approved by AICTE (New Delhi), Government of Maharashtra & DTE, Affiliated to University of Mumbai & MSBTE, Estd. 2009  
A NAAC Accredited Institute | Institute Code: EN3222

## Certificate

*This certificate is awarded to*

*Mr./Ms. PURVA BHUPENDR CHAUDHARI of TE (CIVIL)*

*for Co-ordinating / Participating / Securing FIRST RUNNER-UP in the event of  
BOAT CHALLENGE at JASHN-E-THEEM on 13<sup>th</sup> MARCH '2023*



Event Co-ordinator

PRINCIPAL

THEEM COLLEGE OF ENGINEERING  
At Village Betegaon, Boisar Chilhar Road  
Boisar (East) Tal. & Dist. Palghar - 401 501

Principal





H. J. THIM TRUST'S  
**THEEM COLLEGE OF ENGINEERING**

Approved by AICTE (New Delhi), Government of Maharashtra & DTE, Affiliated to University of Mumbai & MSBTE, Estd. 2009  
A NAAC Accredited Institute | Institute Code: EN3222

# Certificate

*This certificate is awarded to*

Mr./Ms. PURVA CHAUDHARY of T.E. (CIVIL)  
for Co-ordinating / Participating / Securing 2<sup>nd</sup> RUNNER UP in the event of  
BRIDGE DESIGN COMPETITION at **JASHN-E-THEEM** on 14/03/2023



  
Event Co-ordinator

  
PRINCIPAL  
THEEM COLLEGE OF ENGINEERING  
At Village Betegaon, Boisar Chilhar Road,  
Boisar (East) Tal. & Dist. Palghar - 401 501

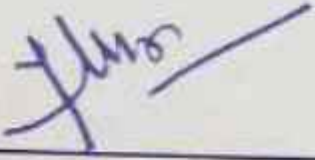
  
Principal





H. J. THIM TRUST'S  
**THEEM COLLEGE OF ENGINEERING**

Approved by AICTE (New Delhi), Government of Maharashtra & DTE, Affiliated to University of Mumbai & MSBTE, Estd. 2009  
A NAAC Accredited Institute | Institute Code: EN3222

# Certificate

*This certificate is awarded to*

*Mr./Ms. PURVA CHAUDHARY of T-E (CIVIL)*

*for Co-ordinating / Participating / Securing FIRST RUNNER UP in the event of  
TRADITIONAL DAY at JASHN-E-THEEM on 10<sup>th</sup> MARCH, 2023*



*[Signature]*  
Event Co-ordinator

*[Signature]*  
- PRINCIPAL  
THEEM COLLEGE OF ENGINEERING  
At Village Betegaon, Boisar Chilhar Road,  
Boisar (East) Tal. & Dist. Palghar - 401 501

*[Signature]*  
Principal





# H. J. THIM TRUST'S THEEM COLLEGE OF ENGINEERING

Approved by AICTE (New Delhi), Government of Maharashtra & DTE, Affiliated to University of Mumbai & MSBTE, Estd. 2009  
A NAAC Accredited Institute | Institute Code: EN3222

## Certificate

*This certificate is awarded to*

Mr./Ms. PURVA BHUPENDRA CHAUDHARI of T-E (CIVIL)

*for Co-ordinating / Participating / Securing* SECOND RUNNER UP *in the event of*

TOWN PLANNING at **JASHN-E-THEEM** on 13<sup>th</sup> MARCH, 2023



  
Event Co-ordinator

  
PRINCIPAL  
THEEM COLLEGE OF ENGINEERING  
AL Village Betegaon, Boisar Chilhar Road,  
Boisar (East) Tal. & Dist. Palghar - 401 501

  
Principal





# H. J. THIM TRUST'S THEEM COLLEGE OF ENGINEERING

Approved by AICTE (New Delhi), Government of Maharashtra & DTE, Affiliated to University of Mumbai & MSBTE, Estd. 2009  
A NAAC Accredited Institute | Institute Code: EN3222

## Certificate

This certificate is awarded to

Mr./Ms. PURVA CHAUDHARI of TE (CIVIL)

for Co-ordinating / Participating / Securing THIRD PLACE in the event of

DISCUSS THROW at **JASHN-E-THEEM** on 10<sup>TH</sup> MARCH, 2023



Harshal  
Event Co-ordinator

[Signature]  
PRINCIPAL  
THEEM COLLEGE OF ENGINEERING  
At Village Betegaon, Boisar Chilhar Road,  
Boisar (East) Tal. & Dist. Palghar - 401 501.

[Signature]  
Principal





# H. J. THIM TRUST'S THEEM COLLEGE OF ENGINEERING

Approved by AICTE (New Delhi), Government of Maharashtra & DTE, Affiliated to University of Mumbai & MSBTE, Estd. 2009  
A NAAC Accredited Institute | Institute Code: EN3222

## Certificate

This certificate is awarded to

Mr./Ms. PURVA CHUUDHARI of TE[CIVIL]

for ~~Co-ordinating~~ / ~~Participating~~ / ~~Securing~~ \_\_\_\_\_ in the event of  
RAMP BURN at **JASHN-E-THEEM** on 15th MARCH 2023.



[Signature]  
Event Co-ordinator

[Signature]  
PRINCIPAL  
THEEM COLLEGE OF ENGINEERING  
At Village Betegaon, Boisar Chilhar Road  
Boisar (East) Tal. & Dist. Palghar - 401 501

[Signature]  
Principal



H. J. THIM TRUST'S  
**THEEM COLLEGE OF ENGINEERING**

Approved by AICTE (New Delhi), Government of Maharashtra & DTE, Affiliated to University of Mumbai & MSBTE, Estd. 2009  
A NAAC Accredited Institute | Institute Code: EN1222

# Certificate

This certificate is awarded to

Mr./Ms. SAI APARNA MAHENDRA POOJARI of SE (AI & ME)

for Co-ordinating / Participating / Securing WINNER in the event of  
DANCE at JASHN-E-THEEM on 15<sup>th</sup> MARCH '2023

  
Event Co-ordinator

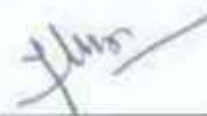
  
Principal

Village Befegaon, Boisar Chilhar Road, Boisar (E), Tal. & Dist. Palghar - 401 501. | Office: 7769916109 | Admission: 7506830077



  
PRINCIPAL  
THEEM COLLEGE OF ENGINEERING  
AL Village Befegaon, Boisar Chilhar Road,  
Boisar (East) Tal. & Dist. Palghar - 401 501





H. J. THIM TRUST'S  
**THEEM COLLEGE OF ENGINEERING**

Approved by AICTE (New Delhi), Government of Maharashtra & DTE, Affiliated to University of Mumbai & MSBTE, Estd. 2009  
A NAAC Accredited Institute | Institute Code: EN3222

## Certificate

This certificate is awarded to

Mr./Ms. SALAPARNA

of THEEM COLLEGE OF ENGINEERING

for Co-ordinating / Participating / Securing WINNER in the event of  
SOLO DANCE at **JASHN-E-THEEM** on 17<sup>th</sup> MARCH, 2023

Event Co-ordinator

Principal

Village Betegaon, Boisar Chihar Road, Boisar (E), Tal. Palghar - 401 501. | Office: 7769916109 | Admission: 7506830077



PRINCIPAL  
THEEM COLLEGE OF ENGINEERING  
At Village Betegaon, Boisar Chihar Road,  
Boisar (East) Tal. & Dist. Palghar - 401 501



H. J. THIM TRUST'S  
**THEEM COLLEGE OF ENGINEERING**

Approved by AICTE (New Delhi), Government of Maharashtra & DTE, Affiliated to University of Mumbai & MSBTE, Estd. 2009  
A NAAC Accredited Institute | Institute Code: EN3222

# Certificate

This certificate is awarded to

Mr./Ms. DUBEY ADARSH

of T.E. [COMPUTER]

for Co-ordinating / Participating / Securing WINNER in the event of  
FOOTBALL at **JASHN-E-THEEM** on 15<sup>th</sup> MARCH, 2023



Harshad

Event Co-ordinator

PRINCIPAL  
THEEM COLLEGE OF ENGINEERING  
At Village Betegaon, Boisar Chilhar Road,  
Boisar (East) Tal. & Dist. Palghar - 401 501

Principal

Village Betegaon, Boisar Chilhar Road, Boisar (E), Tal. & Dist. Palghar - 401 501. | Office: 7769916109 | Admission: 7506830077





# H. J. THIM TRUST'S THEEM COLLEGE OF ENGINEERING

Approved by AICTE (New Delhi), Government of Maharashtra & DTE, Affiliated to University of Mumbai & MSBTE, Estd. 2009  
A NAAC Accredited Institute | Institute Code: EN3222

## Certificate

This certificate is awarded to

Mr./Ms. SHRADDHA DESHMUKH of T.E (IT)

for ~~Co-ordinating / Participating~~ FIRST RUNNER - UP in the event of  
TECHNICAL PPT DASHN-E-THEEM on 14<sup>th</sup> MARCH, 2023



Event Co-ordinator

  
PRINCIPAL  
THEEM COLLEGE OF ENGINEERING  
AL Village Betegaon, Boisar Chilhar Road  
Boisar (East) Tal. & Dist. Palghar - 401 501

Principal



# H. J. THIM TRUST'S THEEM COLLEGE OF ENGINEERING

Approved by AICTE (New Delhi), Government of Maharashtra & DTE, Affiliated to University of Mumbai & MSBTE, Estd. 2009  
A NAAC Accredited Institute | Institute Code: EN3222

## Certificate

This certificate is awarded to

Mr./Ms. SHRADDHA DESHMUKH of T.E (IT)

for Co-ordinating / Participating / Securing WINNER in the event of  
TRADITIONAL DAY **WIN-E-THEEM** on 10<sup>th</sup> MARCH, 2023

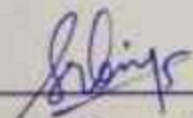

  
Event Co-ordinator

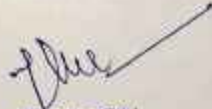
  
PRINCIPAL  
THEEM COLLEGE OF ENGINEERING  
At Village Betegaon, Boisar Chilhar Road,  
Boisar (East) Tal. & Dist. Palghar - 401 501

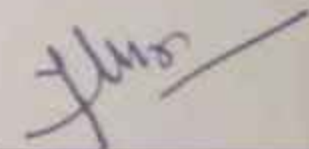
  
Principal





## INTERNSHIP CERTIFICATE

This Certificate Is Awarded To Siddhika Sanjay Thakare

In Recognition of Completion Her one month Internship of 'Python Programming'

Organized by Alvin IT Solutions From 01<sup>th</sup> June, 2023 To 30<sup>th</sup> June, 2023.



Academic Manager

CORPORATE OFFICE

1st floor, Padmakar House, Near Railway Station, opposite Union Bank, Virar (West) 401303



H. J. THIM TRUST'S  
**THEEM COLLEGE OF ENGINEERING**

Approved by AICTE (New Delhi), Government of Maharashtra & DTE, Affiliated to University of Mumbai & MSBTE, Estd. 2009  
A NAAC Accredited Institute | Institute Code: EN3222

# Certificate

This certificate is awarded to  
Mr/Ms. UMAIR SHAIKH of T.E (COMPS) THEEM  
for Co-ordinating / Participating / Securing \_\_\_\_\_ in the event of  
WEBATHON (INTRA) at **JASHN-E-THEEM** on 16<sup>th</sup> MARCH, 2023.

Event Co-ordinator

Principal

Village Betegaon, Boisar Chilhar Road, Boisar (E), Tal. & Dist. Palghar - 401 501. | Office: 7769916109 | Admission: 7506830077



PRINCIPAL  
THEEM COLLEGE OF ENGINEERING  
At Village Betegaon, Boisar Chilhar Road,  
Boisar (East) Tal. & Dist. Palghar - 401 501.





H. J. THIM TRUST'S  
**THEEM COLLEGE OF ENGINEERING**

Approved by AICTE (New Delhi), Government of Maharashtra & DTE, Affiliated to University of Mumbai & MSBTE, Estd. 2009  
A NAAC Accredited Institute | Institute Code: EN3222

# Certificate

This certificate is awarded to

Mr./Ms. UMAIR SHAIKH of T.E (COMPUTER)

for Co-ordinating / Participating / Securing RUNNER-UP in the event of  
KABADDI at **JASHN-E-THEEM** on 13<sup>th</sup> MARCH, 2023

  
\_\_\_\_\_  
Event Co-ordinator

  
\_\_\_\_\_  
Principal

Village Betegaon, Boisar Chilhar Road, Boisar (E), Tal. & Dist. Palghar - 401 501. | Office: 7769916109 | Admission: 7506830077



  
PRINCIPAL  
THEEM COLLEGE OF ENGINEERING  
At Village Betegaon, Boisar Chilhar Road,  
Boisar (East) Tal. & Dist. Palghar - 401 501



H. J. THIM TRUST'S  
**THEEM COLLEGE OF ENGINEERING**

Approved by AICTE (New Delhi), Government of Maharashtra & DTE; Affiliated to University of Mumbai & MSBTE, Estd. 2009  
A NAAC Accredited Institute | Institute Code: EN3222

# Certificate

*This certificate is awarded to*

*Mr./Ms.* KANAD PATIL *of* B.E (IT)

*for Co-ordinating / Participating / Securing* WINNER *in the event of*  
WEBATHON *at* **JASHN-E-THEEM** *on* 16<sup>th</sup> MARCH, 2023



Event Co-ordinator

PRINCIPAL  
THEEM COLLEGE OF ENGINEERING  
At Village Betegaon, Boisar Chilhar Road  
Boisar (East) Tal. & Dist. Palghar - 401 501

Principal





*[Signature]*  
PRINCIPAL  
THEEM COLLEGE OF ENGLISH  
At Vengalloor, Thiruvananthapuram  
District of Malappuram, Kerala



Shot on OnePlus  
By SF 2023.03.11 09:39

05/03/2023 CRICKET TEAM UNDER 19





Shot on OnePlus  
By SF 2023.03.11 09:40

05/03/2023 cricket team under 19





Shot on OnePlus

2023.03

05/03/2023

cricket





Shot on OnePlus

By SF 2023.03

05/03/2023

cricket





13/03/2023 COOK WITHOUT FIRE



*[Signature]*  
PRINCIPAL  
THEEM COLLEGE OF ENGINEERING  
At: Village Betegadi, Boisar Chikhar Road,  
Boisar (East) Tal. & Dist. Palghar - 401 501



13/03/2023 | COOK WITHOUT FIRE



*[Signature]*  
PRINCIPAL  
THEEM COLLEGE OF ENGINEERING  
AL. Village Betegada, Boisar Chikhar Road,  
Boisar (East) Tal. & Dist. Palghar - 401 50





RANGOLI  
10/03/2024



*[Signature]*  
PRINCIPAL  
THEEM COLLEGE OF ENGINEERING  
AL Village Betegada, Bolisar Chikkar, Kori  
Bolisar (East) Tal. & Dist. Patghar - 401 501



*[Signature]*  
PRINCIPAL  
THEEM COLLEGE OF ENGINEERING  
Al Village, Rozar, Bunkar Colony, Taluk  
Rozar (Dist. Th. & Dist. Pathankot - 141 001)

14/03/2024 CRICKET TOURNAMENT





14/03/2024 CRICKET TOURNAMENT



*[Signature]*  
- PRINCIPAL  
THEEM COLLEGE OF ENGINEERING  
At Village Betegad, Bolser Chikar Road,  
Polar (East) Tal. & Dist. Palghar - 401 501

A.Y

2021-22





# H. J. THIM TRUST'S THEEM COLLEGE OF ENGINEERING

Approved by AICTE (New Delhi), Government of Maharashtra & DTE, Affiliated to University of Mumbai & MSBTE, Estd. 2009  
NAAC Accredited with B+ Grade

Village Betagaon, Boisar Chilhar Road, Boisar (E), Tal. & Dist.: Palghar - 401 501.

Tel.: (02525) 284 909 • Fax : (02525) 284 927 • Email : info@theemcoe.org • Website : www.theemcoe.org

## Year 4 A.Y.2021-22

Date of event/activity (DD-MM-YYYY)	Name of the event/activity	Name of the organising institution	Name of the student participated
<b>SPORTS (Jashn -E- Theem)</b>			
24/3/2022	Running 100m (Boys)	TCOE	Tejas, Aman, Tanay
24/3/2022	Running 100m (Girls)	TCOE	Mehak, Mariya, Joha
24/3/2022	Running 200m (Boys)	TCOE	Tejas, Aman, Tanay
24/3/2022	Relay (4*100) (Boys)	TCOE	Maaz, Mavia, Aman
24/3/2022	Relay (4*100) (Girls)	TCOE	Mehak, Mariya, Joha
24/3/2022	Long Jumps (Boys)	TCOE	Arpit, Shakir
24/3/2022	Long Jumps (Girls)	TCOE	Prandhnya, Aalisha, Himanshi
24/3/2022	Discuss Throw (Boys)	TCOE	Joshil, nitesh, shushant
24/3/2022	Discuss Throw (Girls)	TCOE	Samruddhi, Aalisha
24/3/2022	Shot Put (Boys)	TCOE	Hanish, Mayur
24/3/2022	Shot Put (Girls)	TCOE	Samruddhi, Pradnya
24/3/2022	Javelin (Boys)	TCOE	Bhaves, Rizwan, Daniyal
24/3/2022	Javelin (Girls)	TCOE	Prandhnya, Aalisha, Himanshi
21/3/2022 to 24/3/2022	Carrom Singles (Boys)	TCOE	Shalal, arpit
21/3/2022 to 24/3/2022	Carrom Singles (Girls)	TCOE	Jannat, Diksha
21/3/2022 to 24/3/2022	Carrom Doubles (Boys)	TCOE	Usman, Maaz
21/3/2022 to 24/3/2022	Carrom Doubles (Girls)	TCOE	Diksha, Chinmayi
21/3/2022 to 24/3/2022	Chess (Boys)	TCOE	Arpit, Shakir
21/3/2022 to 24/3/2022	Chess (Girls)	TCOE	Hinmave, Ankita
21/3/2022 to 24/3/2022	Badminton Singles (Boys)	TCOE	Amey, Shalaj
21/3/2022 to 24/3/2022	Badminton Singles (Girls)	TCOE	Maitri, prandhnya
21/3/2022 to 24/3/2022	Badminton doubles (Girls)	TCOE	Maitri, samrudhi,
21/3/2022 to 24/3/2022	Badminton doubles (Boys)	TCOE	Vipul, sumit
23/3/2022	Throwball (Girls)	TCOE	sofia Shaikh, maitri, samrudhi
22/3/22 to 23/3/2022	Volleyball (Boys)	TCOE	Chinmay, vipul, kaiwlay, Shubham
23/3/2022	Football (Boys)	TCOE	ismail, jay velkar, mohit, aakash

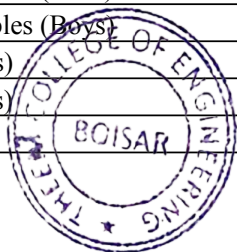

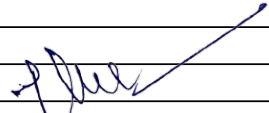
  
**PRINCIPAL**  
 THEEM COLLEGE OF ENGINEERING  
 AL Village Betagaon, Boisar Chilhar Road  
 Boisar (East) Tal. & Dist. Palghar - 401 501

23/3/2022	Tug of War (Boys)	TCOE	Umar Kahan, swapnil, Harsh
23/3/2022	Tug of War (Girls)	TCOE	Saniya, bhavna, himanshi, aayasha
21/3/22 to 24/3/2022	Cricket (Girls)	TCOE	Anjali, maitri, smruthi
21/3/22 to 24/3/2022	Open Cricket (Boys)	TCOE	Chinmay, vipul, kaiwlay, Shubham
21/3/22 to 24/3/2022	Open Cricket (Boys) (INTER)	TCOE	Nilesh, Mohan, Soham
22/3/22 to 23/3/2022	Volleyball (Boys) (INTER)	TCOE	vipul pimple, chinmay, swapnil
<b>Cultural (Jashn -E- Theem)</b>			
22/3/2022	Ramp Burn	TCOE	Pragati, Rashika, Rahul, Ritik
22/3/2022	Hand Writing Competition	TCOE	Swarupa, Maitri, Himanshi
22/3/2022	Poster Drawing	TCOE	Suraj , Manjaree, Shubham
21/3/2022	Traditional Day (Girls)	TCOE	Sofia, Maitri,
22/3/2022	Traditional Day (Boys)	TCOE	Bhushan, Kirtan,
22/3/2022	Mismatch Day(Boys)	TCOE	Vipul pimple, Nilesh, Vipul
22/3/2022	Mismatch Day(Girls)	TCOE	Suvankar, Aasiya, Drushti
21/3/2022	Mehendi Competition	TCOE	Priyanka, Ankita, Dhanshree
21/3/2022	Rangoli Competition	TCOE	Tanvesh, Kiran, Manshi
21/3/2022	Nail art Competition	TCOE	Diksha, Tejal, Aasiya
22/3/2022	Best out of waste	TCOE	Iram, Namira, Mansi
23/3/2022	Tattoo Painting	TCOE	Aasiya, Ankita, jannat
23/3/2022	Salad Decoration	TCOE	Saniya, Aasiya, Namira
24/3/2022	Solo Dance	TCOE	Shrisha, Sakshi , Aishwarya
24/3/2022	Dance (Group)	TCOE	Shrisha, Tejal, Mohit
24/3/2022	Drama	TCOE	Qadri, Moiz, Shebaz, anaf



  
**PRINCIPAL**  
**THEEM COLLEGE OF ENGINEERING**  
 At Village Betegaon, Boisar Chithar Road  
 Boisar (East) Tal. & Dist. Patghar - 401 501





H.J. Thim Trust's

# THEEM COLLEGE OF ENGINEERING

Success through quality education!

Village Betegaon, Bilsar (E), Taluka Palehar, Dist-Dahej

E-mail: principal@theemcoe.org / Website: www.theemcoe.org

Date:- 11/03/2022

## NOTICE

Following Staffs and students are appointed as various Sports Coordinator for ATHLON-22.

Sr No.	Event Name	Staff Coordinator	Contact No	Student Coordinator	Contact No.	Event Date
1	Cricket (For Boys)	Prof. Iqbal Mansoori (Mech)	9405200984	Abhishek Jha	9527062717	21/3/2022 To 24/3/2022
		Mr. Sumit Mhatre(IT)	9730408448	Shubham Dubey	7977800699	
		Mr. Priyasan Thakur	7709355703	Ajay Karankale	7378481885	
		Mr. Ravi Dhavne		Bhavik Pimple	9834808460	
		Mr. Rupesh Sunkhe		Moohd Shamim	7558598903	
		Prof. Iqbal Shaikh (Comp)		Shubham Mishra	7219777461	
	Mr. Rahul Raut		Prabhat	8856822336		
1	Cricket (For Girls)	Prof. <del>Sheeba Naik</del>	(Dip Comp)	Alisha Shaikh, Mahck Shaikh	TE Comp	23-03-2022
		Mrs. Sayli Paul		Saniya Shaikh		
2	Football	Prof. Raise Ahmed	9373884733	Ajinkya Chavan	8779833138	23-03-2022
		Prof. Shafiq Habib	8879498622	Yashesh Patel	7262930625	
		Mr. Sayed Kazim	7020173328	Himansh Patil	9156145101	
		Prof. Zaid Ansari		Shlok Tave	7887769983	
		Mr. Sandesh Patil		Shahzeb kazi	8879910193	
3	Volleyball (For Boys)	Prof. Abdul Bari (Mech)	8928595274	Vipul Pimple	9011799978	22/3/2022 To 23/3/2022
		Mr. Roshan Wade	9665817666	Harsh Bari	9158746428	
		Prof. Ansar Shaikh (IT)		Kavayalia Kawali		
4	Throwball (For Girls)	Mr. Faizan Shaikh				23-03-2022
		Prof. Navvyothi Katela	Electrical Dept.	Kiran Sundkar, Alisha shaikh	TE-COMP	
		Mrs. Hemlata Jangle	IT Dept.	Pragati Kambdi, Pranali S.	TE-IT	



THEEM COLLEGE OF ENGINEERING

At. Village Betegaon, Bilsar Chithar Road,  
Bilsar (East) Tal. & Dist. Palehar - 382405

## Athletics

Sr No.	Event Name	Staff Coordinator	Student Coordinator	Contact No.	Event Date	
<b>Outdoor Games</b>						
1	Athletics	100m Boys	Prof.Nitin Galwade (9765505906)	Atharva Angre	8010049259	24-03-2022
		100m Girls	Prof.Kazi Azimuddin (9579850730)	Laukik	8767884544	
		200 m	Prof.Abid Manyar (8208700264)	Yash	7822914147	
		Relay	Mr.Firoz Pathan	Amit	7058870185	
		Javelin				
		Disc Throw Short Put	Prof. Rupali Kadvane Mrs.Surekha Attarde(For Girls)	Maitrayee Vartak Pranali Sonawane	TE-IT TE-IT	
<b>Indoor Games</b>						
2	Chess (Boys and Girls)	Prof.Moinuddin Ansari (8275589497)	Sajid Kahn	9172006376	21/3/2022	
		Prof.Ayaz Bagwan (9657063365)	Chetna Ghalap (For Girls)	FY	To 24/3/2022	
3	Carrom (Boys)	Prof.Sayed Layak (9975584278)	Harsh Prajapati	9607741812	21/3/2022	
	Carrom (Girls)	Mrs.Vaishali Patil (Girls)	Sajid Kahn	9172006376		
4	Badminton (Boys)	<del>Prof. Minad Shrivastava</del>	Aishwarya Golatkar	SE Comp	24/3/2022	
		Prof.Zulfiqar Ahmed (9923510075)	Priyanka Bhide	SY Comp		
		Prof.Ahmed Shaikh (8793727493)	Omkar Pawar	9082306634		
	Badminton (Girls)	Prof.Sayed Farhan (8976261890)	Shesh Dhruv	8007788210	21/3/2022	
		Mrs.Sayali Pimple (Comp) (Girls)	Kavayalia Kawali			
		Mrs.Pratiksha Wade (Comp) (Girls)	Alisha Shaikh	TE Comp		
5	Tug of War (Boys & Girls)	Prof.Arsalan Khan (8149711979)	Nandeeta Kumari	TE Comp	To 24/3/2022	
		Prof.Hatim Jawadwala (8208862604)	Umar Khan	9975612359		
		Mrs.Sayali Pimple (Girls)	Sunil Yadav	8108763484		
		Mrs.Pratiksha Wade (Girls)	Varma Dhashrath	8698129743		
		Prof.Sajid Shaikh (7756831397)	Shaikh Jera	8857038251		
<b>First Aid (Medical Attention)</b>						
		Prof. Sajid Shaikh (7756831397)				

Staff Sports Incharge  
Prof. Ansar Sheikh  
Prof. Harshal Ahire



**PRINCIPAL**

THEEM COLLEGE OF ENGINEERING  
At. Village Betegaon, Boisar Chilhara Road, Palahar - 391  
Boisar (East) Tal. & Dist. Palahar - 391

Student Sport Incharge

Rufi Fakkil 9049171533  
Yash Singh 8268215930





H. J. THIM TRUST'S

## THEEM COLLEGE OF ENGINEERING

### NOTICE

Date: 18/03/2022

All the students are hereby informed that, the college level Football (Boys) events will be starting from 23 Mar 2022. All the interested students should enroll your name as Group on or before 20 Mar 2022.

(Entry fees for Group /Team is Rs 50.)

Following Students Coordinators:-

ISMAIL (TE IT)

JAY VALEKAR (SE COMP)

MOHIT (BE MECH)

AAKASH (TE ELE)

#### Staff Coordinator

Prof. Abid Manyar

#### Sport Coordinator

Prof. Harshal Ahire

Prof. Ayaz Bagwan.



PRINCIPAL  
THEEM COLLEGE OF ENGINEERING  
At. Village Betegaon, Borsar Chitkar Road,  
Borsar (East) Tal. & Dist. Palghar - 401 304

# JASHN-E-THEEM 2022

## Football(Boys)

### 23 MAR 2022

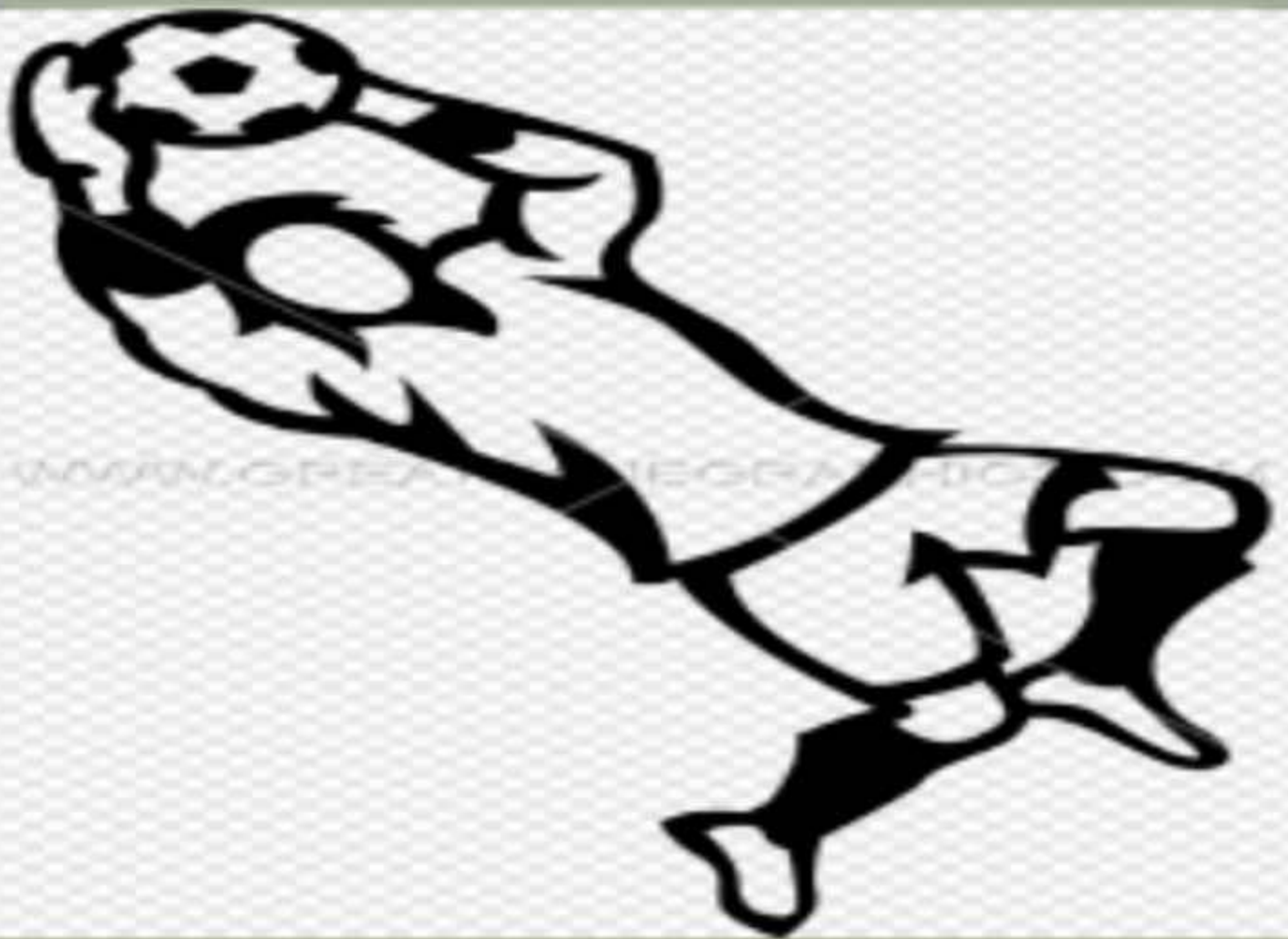

**Student Coordinators**

Ismail (TE IT)

Mohit (BE Mech)

Jay Valekar (SE Comp)

Aakash (TE ELE)

**Staff Coordinators**

Prof Abid Manjari (8983189619)



**PRINCIPAL**

THEEM COLLEGE OF ENGINEERING  
St. Village Betegaon, Boisar Chikar District  
Boisar (East) Tal. & Dist. Palanpur





H. J. THIM TRUST'S

# Theem College of Engineering, Boisar

Approved by AICTE (New Delhi) Government of Maharashtra & DTE  
Affiliated to University of Mumbai Est.: - 2009 - 2010

Football Winner

Name of Winners: (In Capital Letters Only)

(C)

Sr.No	Name	Branch	Year	Mob. No.
1	MD. ISMAIL R Shaikh	MECH	T.E	7276032110
2	JAY VELKAR	AUTO	T.E	
3	MOHIT MER	MECH	B.E	
4	AKASH SONIKAR	MECH	T.E	
5	BOBBY PANDEY	AUTO	T.E	
6	AAQIB PANGARKAR	AUTO	T.E	
7	ARPIT SHARMA	MECH	B.E	
8	TANVEER SIDDIQUI	MECH	B.E	
9	FAIZ SIDDIQUI	MECH	B.E	
10	PRANAV DAVANKAR	AUTO	T.E	
11	SAHIL LAD	MECH	B.E	
12	BHAVIN DARJI	MECH	B.E	
13	YASHESH PATEL	MECH	T.E	
14	RINSON VARGHESE	CIVIL	B.E	

15. FAHEEM RIYAZ SHAIKH MECH S.E

16. MD. MAAZ M. SHAIKH MECH T.E

Best scorers - Aaqib & Rinson Varghese  
(Trophy - 1, certificate - 02)

Event Incharge



Head  
Prof. Raees Ahmed  
*Raees Ahmed*

Received by:  
Prof.

P.D. Head  
Prof. *[Signature]*

PRINCIPAL  
THEEM COLLEGE OF ENGINEERING  
At, Village Betegaon, Boisar Chitradistrict  
Boisar (East) Tal. & Dist. Palghar



H. J. THIM TRUST'S

# Theem College of Engineering, Boisar

Approved by AICTE (New Delhi) Government of Maharashtra & DTE  
Affiliated to University of Mumbai Est.: - 2009 - 2010

## Jashn-e-Theem 2022

### List of Winner of Group Event

Category: Technical/ Sports/ Cultural (Tick any one)

Date: 23/03/2022

Name of Event: FOOTBALL: Football

Kindly award Certificate and Medals/ Trophies to the following students.

Name of Winners: (In Capital Letters Only)

1	M	D	I	S	M	A	I	L	S	H	A	I	K	H					
2	J	A	Y	V	E	L	K	A	R										
3	M	O	H	I	T	V	M	E	R										
4	A	K	A	S	H	S	O	N	I	K	A	R							
5	B	O	B	B	Y	P	A	N	D	E	Y								
6	A	A	A	Q	I	B	P	A	N	G	A	R	K	A	R				
7	A	R	P	I	T	S	H	A	R	M	A								
8	T	A	N	V	E	E	R	S	I	D	D	I	Q	U	I				
9	F	A	I	Z	S	I	D	D	I	Q	U	I							
10	P	R	A	N	A	V	D	A	V	N	A	K	A	R					
11	S	A	H	I	L	L	A	D											
12	B	H	A	V	I	N	D	A	R	J	I								
13	Y	A	S	H	E	S	H	P	A	T	E	L							
14	R	I	N	S	O	N	V	A	G	H	E	S	E						



Event Incharge

Prof.

Head  
Prof.

Received by:  
Prof.

P.D. Head

PRINCIPAL  
THEEM COLLEGE OF ENGINEERING  
At Village Betegaon, Boisar Chithar Rd,  
Boisar (East) Tal. & Dist. Palghar.

THEEM MAAZ SHAIKH  
RIYAZ SHAIKH





H. J. THIM TRUST'S

# Theem College of Engineering, Boisar

Approved by AICTE (New Delhi) Government of Maharashtra & DTE  
Affiliated to University of Mumbai Est.: - 2009 - 2010

## Football Runners

Name of 1<sup>st</sup> Runner-Up: (In Capital Letters Only)

Sr.No	Name	Branch	Year	Mob. No.
1	PARAS KUSHWAHA	IT	BE	
2	AJIT DUBEY	IT	BE	
3	NITIN MISHRA	IT	BE	
4	ASHAY GAWANE	IT	BE	
5	SHUBH KHANDHAR	IT	T.E	
6	SAGAR BATTULA	IT	BE	
7	RUGVED PATIL	IT	SE	
8	SHUBHAM SAWANT	COMPS	BE	
9	RAJ DADHANIYA	COMPS	T.E	
10	MAYURESH SUTAR	COMPS	BE	
11	ASHISH BANGERA	COMPS	BE	
12	DEEPAK SHARMA	IT	SE	
13	SHAAL EDAPPAYIL	IT	TE	
14	AMAN BAWALA	TECH DIPLOMA	T.V	
15.	BHUSHAN MAHALE	IT	BE	
✓ 16.	ARUNAY JADHAV	COMPS	BE	

Event Incharge



*[Signature]*  
Head  
Prof. Kees Ahmad

Received by  
Prof.

*[Signature]*

*[Signature]*  
PD Head  
Prof. PRINCIPAL

THEEM COLLEGE OF ENGINEERING  
At Village Betegaon, Boisar Chikhar Road  
Boisar (East) Tal. & Dist. Palghar - 401 301







H. J. THIM TRUST'S

## THEEM COLLEGE OF ENGINEERING

### NOTICE

Date: 18/03/2022

All the students are hereby informed that, the college level Throwball (Girls) events will be starting from 23 Mar 2022. All the interested students should enroll your name as Group on or before 20 Mar 2022.

(Entry fees for Group /Team is Rs 50.)

Following Students Coordinators:-

SOFIA SHAIKH (SE IT)

SAMRUDHI(SE IT)

MAITRI (BE COMP)

#### Staff Coordinator

Prof. Sonali kartik

#### Sport Coordinator

Prof. Harshal Ahire

Prof. Ayaz Bagwan.



PRINCIPAL  
THEEM COLLEGE OF ENGINEERING  
At Village Betegaon, Boisar Chitthar Road,  
Boisar (East) Tal. & Dist. Palohar - 475 101

**JASHN-E-THEEM 2022**

**THROWBALL**

**23 MAR 2022**



**Student Coordinators**

**Sofia Shaikh (SE IT)**

**Maitri (BE Comp)**

**Samruddi (SE IT)**

**Staff Coordinators**

**Prof Sonali Kartik (9503461683)**

A handwritten signature in blue ink, appearing to be 'S. Kartik', written in a cursive style.

**PRINCIPAL**

**THEEM COLLEGE OF ENGINEERING**  
At Village Betegaon, Bolser Chittur R.  
Bolser (East) Tal. & Dist. Palghar





H. J. THIM TRUST'S

# Theem College of Engineering, Boisar

Approved by AICTE (New Delhi) Government of Maharashtra & DTE  
Affiliated to University of Mumbai Est.: - 2009 - 2010

Event :- Throw Ball (Girls)

Name of Winners: (In Capital Letters Only) IT

Sr.No	Name	Branch	Year	Mob. No.
1	SOFIYA SHEIKH	BT	B.E.	
2	MAITREYI VARTAK	IT	T.E.	
3	SAMRUDDHI NAIK	IT	B.E.	
4	ANJALI PUROHIT	IT	T.E.	
5	SMRUTI BHANDARKAR	IT	B.E.	
6	RUTUJA JADHAV	IT	S.E.	
7	Saniya Sheikh	IT	B.E.	
8				
9				
10				
11				
12				
13				
14				



Prof.  Head

Received by:  
Prof.



**PRINCIPAL**  
THEEM COLLEGE OF ENGINEERING  
At Village Betegaon, Boisar Chithar Road  
Boisar (East) Tal. & Dist. Palghar - 401 301

P.D Head  
Prof.



H. J. THIM TRUST'S

# Theem College of Engineering, Boisar

Approved by AICTE (New Delhi) Government of Maharashtra & DTE  
Affiliated to University of Mumbai Est.: - 2009 - 2010

## Jashn-e-Theem 2022

### List of Winner of Group Event

Category: Technical/ Sports/ Cultural (Tick any one)

Date: 24/03/2022

Name of Event: Throwball (girls)

Kindly award Certificate and Medals/ Trophies to the following students.

Name of Winners: (In Capital Letters Only)

1	S	O	F	I	Y	A	S	H	B	I	K	H								
2	M	A	I	T	R	E	Y	I	V	A	R	T	A	K						
3	S	A	M	R	U	D	D	H	I	N	A	I	K							
4	A	N	J	A	L	I	P	U	R	O	H	I	T							
5	S	M	R	U	T	I	B	H	A	N	D	A	R	K	A	R				
6	R	U	T	V	J	A	J	A	D	H	A	V								
7																				
8																				
9																				
10																				
11																				
12																				
13																				
14																				



Prof. \_\_\_\_\_ Head

Prof. [Signature] Received by

Prof. \_\_\_\_\_ P.D Head

PRINCIPAL  
THEEM COLLEGE OF ENGINEERING  
At, Village Betogaon, Boisar Chikhar Road,  
Boisar (East) Tal. & Dist. Palohar - 401 201





H. J. THIM TRUST'S

# Theem College of Engineering, Boisar

Approved by AICTE (New Delhi) Government of Maharashtra & DTE  
Affiliated to University of Mumbai Est.: - 2009 - 2010

Event :- Throw Ball (Girls)

Name of 1<sup>st</sup> Runner-Up: (In Capital Letters Only) COMPS

Sr.No	Name	Branch	Year	Mob. No.
1	ALISHA SHAIKH	Comps	TE	
2	MAHEK SHAIKH	Comps		
3	MARIYA SIDDIQUI	Comps		
4	ZONA SHAIKH	Comps		
5	SABIHANAZ SHAIKH	Comps		
6	SWARUPA SARVANKAR	Comps	B.E.	
7	Pradnya fathi	Comps	B.E.	
8				
9				
10				
11				
12				
13				
14				

Event Incharge  
Prof. *[Signature]*  
24/03/2022



*[Signature]*  
Prof. Head

Received by *[Signature]*  
Prof. P.D Head

PRINCIPAL

THEEM COLLEGE OF ENGINEERING  
At Village Betegaon, Boisar Chithar Road  
Boisar (East) Tal. & Dist. Palghar - 401 301







H. J. THIM TRUST'S

## THEEM COLLEGE OF ENGINEERING

### NOTICE

Date: 17/03/2022

All the students are hereby informed that, the college level Volleyball(Boys) events will be starting from 22 Mar 2022. All the interested students should enroll your name as Group on or before 19 Mar 2022.

(Entry fees for Group /Team is Rs 100.)

Following Students Coordinators:-

CHINMAY(BE CIVIL)

KAIWLAY (TE COMP)

VIPUL (BE MECH)

#### Staff Coordinator

Prof. Harshal Ahire

Prof. Ayaz bagwan

#### Sport Coordinator

Prof. Harshal Ahire

Prof. Ayaz Bagwan.



PRINCIPAL  
THEEM COLLEGE OF ENGINEERING  
At, Village Betogaon, Boisar Chitkar Road,  
Boisar (East) Tal. & Dist. Palghar - 401302.

JASHN-E-THEEM 2022

# Volleyball(Boys)

19 MAR 2022



**Student Coordinators**  
**Chinmaye (BE Civil)**  
**Vipul (BE Mech)**

**Kaiway(TE Comp)**

**Staff Coordinators**  
**Prof Harshal Ahire**  
**Prof Ayaz Bagwan**



A handwritten signature in black ink, appearing to be 'S. J. Ahire', written over a light blue grid background.

**PRINCIPAL**  
THEEM COLLEGE OF ENGINEERING  
At Village Betegaon, Borsar Chitlihar Road,  
Borsar (East) Tal. & Dist. Palohar - 391 125





H. J. THIM TRUST'S  
**Theem College of Engineering, Boisar**

Approved by AICTE (New Delhi) Government of Maharashtra & DTE  
Affiliated to University of Mumbai Est.: - 2009 - 2010

Volley Ball

Winner

Name of ~~the~~ Runner-Up: (In Capital Letters Only) - CIVIL

Best  
defender →  
Best  
smasher →  
Best  
setter →

Sr.No	Name	Branch	Year	Mob. No.
1	Best Player - Vipul Pimple	Civil	BE	9011799978
2	Chinmay Ghart	Civil	TE	
3	Swapnil Gawade	Civil	BE	
4	Harsh Bari	Civil	BE	
5	Hanish Bari	Civil	BE	
6	Ganesh Shete	Civil	TI	
7	Chaitany Mahale	Civil	BE	
8	Ganesh Vartha	Civil	TE	
9				
10				
11				
12				
13				
14				

Event Incharge  
Prof. Abdul Bari

Prof. Head

Received by:  
Prof.

PRINCIPAL

THEEM COLLEGE OF ENGINEERING  
At. Village Betegaon, Boisar Chikhar Road,  
Boisar (East) Tal. & Dist. Palghar - 401 301









H. J. THIM TRUST'S

# Theem College of Engineering, Boisar

Approved by AICTE (New Delhi) Government of Maharashtra & DTE  
Affiliated to University of Mumbai Est.: - 2009 - 2010

Volly Ball

Third Years Mechanical

Name of 1<sup>st</sup> Runner-Up: (In Capital Letters Only) (mech)

Sr.No	Name	Branch	Year	Mob. No.
1	Jiten. Nagambra Das	T.E. MECH		9373474424
2	Ajay Kadamkale	T.E. MECH		7378481885
3	Bani Sahil	TE MECH		8390667954
4	Kunal S. Raut	TE Mech		7276831372
5	Yashesh .J. Patel	TE MECH		7262930625
6	Sumit . S. Pawaskar	TE MECH		7020246052
7	Bhavik Pimple	TE MECH		9834808460
8	Krishna Sharma	TE MECH		9503143632
9				
10				
11				
12				
13				
14				



Prof. [Signature] Head

Received by:  
Prof. [Signature]

[Signature]

PRINCIPAL

THEEM COLLEGE OF ENGINEERING  
At V. P. Betegeon, Boisar Chithar Road  
Palghar (East) Tal. & Dist. Palghar - 402



H. J. THIM TRUST'S

## THEEM COLLEGE OF ENGINEERING

### NOTICE

Date: 17/03/2022

All the students are hereby informed that, the college level cricket (Girls) events will be starting from 21 Mar 2022. All the interested students should enroll your name as Group on or before 19 Mar 2022.

(Entry fees for Group /Team is Rs 50.)

Following Students Coordinators:-

ANJALI (TE COMP)

SMRUTHI (SE COMP)

MATRI (TE IT)

#### Staff Coordinator

Prof. Harshal Ahire

Prof Hemalata j

#### Sport Coordinator

Prof. Harshal Ahire

Prof. Ayaz Bagwan.



PRINCIPAL  
THEEM COLLEGE OF ENGINEERING  
At Village Betegaon, Boisar Chithar Road  
Boisar (East) Tal. & Dist. Palohar - 401 202



# JASHN-E-THEEM 2022

## CRICKET (GIRLS)

21 MAR 2022



**Student Coordinators**

**ANJALI (TE COMP)**

**MAITRI (TE IT)**

**SMRUTHI (SE COMP)**

**Staff Coordinators**

**Prof Harshal Ahire(8275124797)**

**PRINCIPAL**

**THEEM COLLEGE OF ENGINEERING**  
Village Belgaon, Bolser Chimer,  
Dist. Pathe...



H. J. THIM TRUST'S  
**Theem College of Engineering, Boisar**

Approved by AICTE (New Delhi) Government of Maharashtra & DTE  
Affiliated to University of Mumbai Est.: - 2009 - 2010

Winner **Cricket Girls**

Name of ~~the Winner~~ <sup>Team</sup>: (In Capital Letters Only)

(Comps)

Man of the  
Series  
Captain

Best  
Batsman

Sr.No	Name	Branch	Year	Mob. No.
1	Alisha Shaikh		TE	
2	Pradnya Patil		BE	
3	Mahek Shaikh		TE	
4	Sabiha Maz Shaikh		BE	
5	Swarupa Sarvankar		BE	
6	Mansi Pathare		SE	
7	Zoha Shaikh		SE	
8	Nandeeta Kumari		TE	
9				
10				
11				
12				
13				
14				



Prof. \_\_\_\_\_ Head

Received by \_\_\_\_\_  
Prof. \_\_\_\_\_  
PRINCIPAL  
THEEM COLLEGE OF ENGINEERING  
At Village Betgaon, Boisar, Tal. Boisar, Dist. Palghar - 401 301





H. J. THIM TRUST'S

# Theem College of Engineering, Boisar

Approved by AICTE (New Delhi) Government of Maharashtra & DTE  
Affiliated to University of Mumbai Est. - 2009 - 2010

## Cricket Girls

Name of 1<sup>st</sup> Runner-Up: (In Capital Letters Only) (IT)

Sr.No	Name	Branch	Year	Mob. No.
1	Aujali Purohit		TE	
2	Maitrayee Vatak		TE	
3	Smruti Bhandarkar		BE	
4	Pranali Sonawane		TE	
5	Rani Shaikh		SE	
6	Ashwini Patil		TE	
7	Ayushi Singh		BE	
8	Saniya Shaikh		BE	
9				
10				
11				
12				
13				
14				

Best Bowler ←

←  
Captain



\_\_\_\_\_  
Prof. Head

\_\_\_\_\_  
Prof. Received by:

**PRINCIPAL**  
THEEM COLLEGE OF ENGINEERING  
At. Village Betegaon, Boisar Chikhar Road  
Boisar (East) Tal. & Dist. Palohar - 401 201



H. J. THIM TRUST'S

## THEEM COLLEGE OF ENGINEERING

### NOTICE

Date: 17/03/2022

All the students are hereby informed that, the college level Tug of war (Boys and Girls) events will be starting from 23Mar 2022. All the interested students should enroll your name as Group on or before 20 Mar 2022.

(Entry fees for Group /Team is Rs 50.)

Following Students Coordinators:-

UMAR KAHAN (SE COMP)

SWAPNIL (FE MECH)

SANIYA (SE IT)

BAVANA (SE ELE)

#### Staff Coordinator

Prof. Abid Manyar

Prof. Priti Mali

#### Sport Coordinator

Prof. Harshal Ahire

Prof. Ayaz Bagwan.



PRINCIPAL

THEEM COLLEGE OF ENGINEERING

At. Village Betegaon, Borsar Chikhar Road

Borsar (East) Tal. & Dist. Palehar - 801 104



# JASHN-E-THEEM 2022

## TUG OF WAR

### 23 MAR 2022



**Student Coordinators**

**UMAR KAHAN (SE COMP)**

**SANIYA (SE IT)**

**SWAPNIL (FE MECH)**

**BAVANA (SE ELE)**

**Staff Coordinators**

**Prof. Abid Manyar (8983189619)**

**Prof. Priti Mali**

A handwritten signature in blue ink, appearing to be 'S. J.', located below the list of coordinators.

**PRINCIPAL**

**THEEM COLLEGE OF ENGINEERING**  
St. Village Betegaon, Botsar Chimer, Palahar (East) Tal. & Dist. Palahar







H. J. THIM TRUST'S  
**Theem College of Engineering, Boisar**

Approved by AICTE (New Delhi) Government of Maharashtra & DTE  
Affiliated to University of Mumbai Est.: - 2009 - 2010

Name of Winners: (In Capital Letters Only)

Sr.No	Name	Branch	Year	Mob. No.
1	Saniya Siddiqui	Civil	BE	9975612359
2	Bharna Singh	-h	-L	
3	Mansi Pawar	-h	-L	
4	Aasiya Kazi	-L	-L	
5	Shivani Chaphekar	-L	TY	
6	Zeenat Ali	-L	-L	
7	Purva Chaudhary	-L	SE	
8	Monika Bhoi	-L	SE	
9	Tetal Lahange	-h	SE	
10	Vidhi Daudi	Electrical COMPS	SY	
11	Sanj patil	COMPS	SY	
12	Mahek Sheikh	-h	SY	
13				
14				



Prof. \_\_\_\_\_ Head

Prof.

Received by:

PRINCIPAL

Prof.

P.D Head

THEEM COLLEGE OF ENGINEERING  
At. Village Betegaon, Boisar Chithar Road  
Boisar (East) Tal. & Dist. Palohar - 405 001



H. J. THIM TRUST'S  
**Theem College of Engineering, Boisar**

Approved by AICTE (New Delhi) Government of Maharashtra & DTE  
Affiliated to University of Mumbai Est.: - 2009 - 2010

# Jashn-e-Theem 2022

## List of Winner of Group Event

Category: Technical/ Sports/ Cultural (Tick any one)

Date: 23/03/22

Name of Event: TUG OF WAR (GIRLS)

Kindly award Certificate and Medals/ Trophies to the following students.

Name of <sup>1<sup>st</sup></sup> Runner-Up: (In Capital Letters Only)

IT

1	S	A	N	I	Y	A	S	H	A	I	K	H								
2	P	R	I	Y	A	N	K	A	A	G	R	E								
3	S	A	K	S	H	I	P	A	D	H	Y	E								
4	S	A	M	R	U	D	D	H	I	N	A	Y	A	K						
5	S	O	F	I	Y	A	S	H	A	I	K	H								
6	M	A	I	T	R	A	Y	E	V	A	R	T	A	K						
7	P	R	A	H	A	L	I	S	O	N	A	W	A	N	E					
8	N	R	U	S	H	T	I	P	A	T	E	L								
9	A	N	J	A	L	I	P	U	R	O	H	I	T							
10	A	N	K	I	T	A	G	U	P	T	A									
11	R	A	N	I	S	H	A	H												
12																				
13																				
14																				



Event Incharge  
Prof. Anzlam Khan

Prof.

Head

Prof.

Received by: **PRINCIPAL** P D Head

**THEEM COLLEGE OF ENGINEERING**  
At Village Betegaon, Boisar Chikhar Road  
Boisar (East) Tal. & Dist. Palghar - 401 301





H. J. THIM TRUST'S  
**Theem College of Engineering, Boisar**

Approved by AICTE (New Delhi) Government of Maharashtra & DTE  
Affiliated to University of Mumbai Est.: - 2009 - 2010

Name of 1<sup>st</sup> Runner-Up: (In Capital Letters Only)

Sr.No	Name	Branch	Year	Mob. No.
1	Saniya shai Kh	IT	BE	
2	Priyanka Agre	-L	-L	
3	Sakshi padhye	-L	-L	
4	Samruddhi Mayak	-L	-L	
5	Sofiya Sheikh	-L	-L	
6	Maitrayee Vastak	-L	TE	
7	paranali Somawane	-L	-L	
8	Vrushiti Patel	-L	BE	
9	Anjali Purohit	-L	TE	
10	Ankita Gupta	-L	SE	
11	Rani Shah	-L	SE	
12				
13				
14				



Event Incharge  
Prof.

Prof. \_\_\_\_\_ Head

Received by:  
Prof.

P.D Head  
Prof.

PRINCIPAL

THEEM COLLEGE OF ENGINEERING  
At. Village Betegaon, Boisar Chithar Road  
Boisar (East) Tal. & Dist. Palghar - M.S.



H. J. THIM TRUST'S

# Theem College of Engineering, Boisar

Approved by AICTE (New Delhi) Government of Maharashtra & DTE  
Affiliated to University of Mumbai Est.: - 2009 - 2010

## Jashn-e-Theem 2022

### List of Winner of Group Event

Category: Technical/ Sports/ Cultural (Tick any one)

Date: 23/03/22

Name of Event: TUG OF WAR (BOYS)

Kindly award Certificate and Medals/ Trophies to the following students.

Name of Winners: (In Capital Letters Only) Civil

1	U	M	A	R	K	H	A	N														
2	S	N	A	P	N	I	L	G	A	W	D	E										
3	H	A	R	S	H	B	A	R	I													
4	C	H	A	I	T	N	Y	A	M	A	K	A	L	E								
5	O	M	K	A	R	P	A	W	A	R												
6	Z	U	B	A	I	R	Q	U	R	E	S	H	I									
7	S	H	A	D	A	B	Q	U	R	E	S	H	I									
8	H	A	N	I	S	H	B	A	R	I												
9	N	O	U	M	A	N	K	H	A	N												
10	K	A	I	V	A	L	Y	A	K	A	V	L	I									
11	K	A	L	P	E	S	H	P	I	T	A	L	E									
12	S	H	A	M	D	U	B	E	Y													
13																						
14																						

Event Incharge  
Prof. Ansalan Khan

Prof.

Head

Received by:  
Prof.

P.D. Head  
PRINCIPAL  
THEEM COLLEGE OF ENGINEERING  
At. Village Betegaon, Boisar Chithar Rd.  
Boisar (East) Tal. & Dist. Palghar - 42





# H. J. THIM TRUST'S Theem College of Engineering, Boisar

Approved by AICTE (New Delhi) Government of Maharashtra & DTE  
Affiliated to University of Mumbai Est.: - 2009 - 2010

Name of Winners: (In Capital Letters Only)

Sr.No	Name	Branch	Year	Mob. No.
1	Umar Khan	Civil	BE	9975612359
2	Swapnil Gawde	Civil	BE	
3	Harsh Bari	Civil	BE	
4	Chaitanya Mahale	-h	-h	
5	OMkar Pawar	-h	-h	
6	Zubair Qureshi	-h	SE	
7	Shardab Qureshi	-h	SE	
8	Hanish Bari	Mech	BE	
9	Mouman Khan	Mech	BE	
10	Kaivalya Karli	Auto	BE	
11	Kalpesh Pitale	Elec	BE	
12	Shubham Dubey	Civil	TE	
13				
14				

PRINCIPAL

THEEM COLLEGE OF ENGINEERING

At Village Betegaon, Boisar Chithar Road  
Boisar (East) Tal. & Dist. Palghar - 401 201

Event Incharge

Prof. \_\_\_\_\_ Head

Received by:  
Prof. \_\_\_\_\_

P.D Head  
Prof. \_\_\_\_\_





H. J. THIM TRUST'S

# Theem College of Engineering, Boisar

Approved by AICTE (New Delhi) Government of Maharashtra & DTE  
Affiliated to University of Mumbai Est.: - 2009 - 2010

## Jashn-e-Theem 2022

### List of Winner of Group Event

Category: Technical/ Sports/ Cultural (Tick any one)

Date: 23/03/22

Name of Event: TUG OF WAR (BOYS)

Kindly award Certificate and Medals/ Trophies to the following students.

Name of  Runner-Up: (In Capital Letters Only) Computer

1	M	U	H	I	B	B	U	R	R	A	H	M	A	N					
2	A	J	I	N	K	Y	A	C	H	A	V	H	A	N					
3	S	H	O	E	B	K	H	A	N										
4	R	U	F	I	F	A	K	K	I										
5	R	U	P	E	S	H	M	A	U	R	Y	A							
6	S	H	A	I	K	H	H	A	R	I	S	H							
7	M	A	H	E	S	H	P	A	L										
8	M	O	H	A	M	M	A	D	R	A	Z	A							
9	A	M	E	N	S	H	A	I	K	H									
10	A	G	D	U	S	D	H	A	N	G	E								
11	S	H	A	H	E	D	S	A	Y	Y	A	D							
12																			
13																			
14																			

Event Incharge

Prof. Arsalan Khan



Head  
Prof. **PRINCIPAL** Prof.  
THEEM COLLEGE OF ENGINEERING  
At Village Betegaon, Boisar Chithar B...  
Boisar (East) Tal. & Dist. Palghar - 40

Received by:

P.D Head  
Prof.





H. J. THIM TRUST'S  
**Theem College of Engineering, Boisar**

Approved by AICTE (New Delhi) Government of Maharashtra & DTE  
Affiliated to University of Mumbai Est.: - 2009 - 2010

Name of 1<sup>st</sup> Runner-Up: (In Capital Letters Only)

Sr.No	Name	Branch	Year	Mob. No.
1	Muhibbursahman	COMP	T.E	
2	Ajinkya charhan	-h	-h	
3	Shoeb Khan	-h	-h	7020176213
4	Rufi fakki	-h	-u	
5	Rupesh Mansya	-h	-h	
6	Shaikh Hamish	-h	-h	
7	Mahesh pal	-h	-h	
8	Mohammad Raza	-h	-h	
9	Amin shaikh	-h	SE	
10	Aqdas Dhangre	-h	SE	9518710720
11	Shahid sayyad	-h	SE	
12				
13				
14				

Event Incharge  
Prof.



Prof.

Head

Received by:

Prof.

P.D Head  
Prof.

PRINCIPAL

THEEM COLLEGE OF ENGINEERING  
At. Village Betegaon, Boisar Chikhar Rd.  
Boisar (East) Tal. & Dist. Palghar - 401 301



H. J. THIM TRUST'S

## THEEM COLLEGE OF ENGINEERING

### NOTICE

Date: 15/03/2022

All the students are hereby informed that, the college level Open cricket intra (Boys) events will be starting from 21Mar 2022. All the interested students should enroll your name as Group on or before 19 Mar 2022.

(Entry fees for Group /Team is Rs 50.)

Following Students Coordinators:-

CHINMAY (BE CIVIL)

KAIWLAY (SE MECH)

VIPUL (BE CIVIL)

#### Staff Coordinator

Prof. Harshal Ahire

#### Sport Coordinator

Prof. Harshal Ahire

Prof. Ayaz Bagwan.



  
PRINCIPAL  
THEEM COLLEGE OF ENGINEERING  
At, Village Betogaon, Bosisar Chilar Road,  
Bosisar (East) Tal. & Dist. Palehar - 40



# JASHN-E-THEEM 2022

## CRICKET

21 MAR 2022



**Student Coordinators**  
**CHINMAY (BE CIVIL)**  
**VIPUL (BE CIVIL)**

**KAIWLAY (SE MECH)**

**Staff Coordinators**  
**Prof Marshal Ahire(8275124797)**



Handwritten signature of the Principal.

**PRINCIPAL**  
THEEM COLLEGE OF ENGINEERING  
Village Betegaon, Bolser Chikar  
Dist. Palghar (East) Tal. & Dist. Palghar



H. J. THIM TRUST'S  
**Theem College of Engineering, Boisar**

Approved by AICTE (New Delhi) Government of Maharashtra & DTE  
 Affiliated to University of Mumbai Est.: - 2009 - 2010

~~CRICKET~~ (CRICKET)

Degree Civil.

Name of Winners: (In Capital Letters Only)

Sr.No	Name	Branch	Year	Mob. No.
1	CHINMAY V GHARAT	TE.CIVIL		96
2	Shazeb Razi (CC)	TE.Civil		
3	VIPUL N. PIMPLE	TE.CMI		
4	Kaivalya. M. Kauli	TE.CIVIL		
5	Shubham. k. Dobey			
6	YASH A. SANKHE		T.E	
7	VIRAJ A. SANKHE			
8	GANESH VARTHA	Civil		
9	Omkar. R. Pawar			
10	Sufijan Chaudhary			
11	Nikhil Malleg Marle			
12	shubham sharma			
13	Arif Siddiqui			
14	chandan yadav			

② Best Bowler - Ganesh Varttha

T.E Civil Degree.



*[Signature]*  
 Prof.

Head  
 Prof.

Received by:  
 Prof.

*[Signature]*  
 P.D Head,  
 Prof.

Man of the Tournament

Chinmay V Gharat - T.E Civil Deg 443

**PRINCIPAL**  
 THEEM COLLEGE OF ENGINEERING  
 At Village Betegaon, Boisar Chithar Road,  
 Tal. East Tal. & Dist. Palghar





H. J. THIM TRUST'S  
**Theem College of Engineering, Boisar**

Approved by AICTE (New Delhi) Government of Maharashtra & DTE  
Affiliated to University of Mumbai Est.: - 2009 - 2010

Name of ~~the~~ Runner-Up: (In Capital Letters Only)

Diploma Civil.

Sr.No	Name	Branch	Year	Mob. No.
1	Tanmay Sankhe.	TY civil	Ty	
2	Ritesh chavan.	civil		
3	Dhruv Shesh.			
4	vedant Raut.			
5	Rutik shelke.	Civil		
6	Ashish Padavale.			
7	Hiranmay Pramank			
8	Tanmay Jadhav.			
9	Omkar- Gaikwad.			
10	Pratik Taware.			
11	<del>Dhruv</del> Dhruv Yadav			
12	Minel Sankhe.			
13	Priyanshu Bari			
14				

1 Best Betsman - Tanmay Sankhe.

T.Y. Civil Diploma

Event Incharge  
Prof.

*Sankhe*

Prof.

Received by:  
*[Signature]*

Prof.

P.D Head  
Prof.



PRINCIPAL

THEEM COLLEGE OF ENGINEERING  
At Village Betegaon, Boisar Chithar Road  
Boisar (East) Tal. & Dist. Palohar - 40



H. J. THIM TRUST'S

## THEEM COLLEGE OF ENGINEERING

### NOTICE

Date: 14/03/2022

All the students are hereby informed that, the college level Badminton Singles and Doubles events will be starting from 21Mar 2022. All the interested students should enroll your name as an Individual or Group on or before 18 Mar 2022.

(Entry fees for Individual are Rs 10 and for Group /Team is Rs 20.)

Following Students Coordinators:-

AMEY (SE IT)

SAMRUDDI (SE IT)

SHALAJ (SE MECH)

MAITRI (TE COMP)

**Staff Coordinator**

Prof. Abid Manyar

**Sport Coordinator**

Prof. Harshal Ahire

Prof. Ayaz Bagwan.



**PRINCIPAL**

THEEM COLLEGE OF ENGINEERING  
At, Village Betegaon, Bolsar Chitlihar Road,  
Bolisar (East) Tal. & Dist. Palohar - 40



**JASHN-E-THEEM 2022**

**BADMINTON**

**21 MAR 2022**



**Student Coordinators**

**Amey (SE IT)**

**Shalaj (SE Mech)**

**Samruddi (SE IT)**

**Maitri (TE Comp)**

**Staff Coordinators**

**Prof Abid Manyar (8983189619)**



**PRINCIPAL**  
THEEM COLLEGE OF ENGINEERING  
At Village Betegaon, Bolsar Chikhar Road,  
Palsar (East) Tal. & Dist. Palohar - Odisha



H. J. THIM TRUST'S

# Theem College of Engineering, Boisar

Approved by AICTE (New Delhi) Government of Maharashtra & DTE  
Affiliated to University of Mumbai Est.: - 2009 - 2010

## Jashn-e-Theem 2022

### List of Winner of Group Event

Category: Technical/ Sports/ Cultural (Tick any one)

Date:

Name of Event: Bussle Badminton Girls (Doubles)

Kindly award Certificate and Medals/ Trophies to the following students.

Name of ~~1<sup>st</sup>~~ Runner-Up: (In Capital Letters Only) 1<sup>st</sup> Runner UP

1	M	A	I	T	R	A	Y	E	E	V	A	R	T	A	K	(T E - I T)		
2	S	A	M	R	U	D	D	H	I	N	A	Y	A	K		(B E - I T)		
3																		
4																		
5																		
6																		
7																		
8																		
9																		
10																		
11																		
12																		
13																		
14																		



Prof. Head  
Prof.

Received by:

Prof. Head

PRINCIPAL

THEEM COLLEGE OF ENGINEERING  
At, Village Betegaon, Boisar Chitner Road  
Boisar (East) Tal. & Dist. Palohar - 401 201





H. J. THIM TRUST'S  
**Theem College of Engineering, Boisar**

Approved by AICTE (New Delhi) Government of Maharashtra & DTE  
Affiliated to University of Mumbai Est.: - 2009 - 2010

*Badminton (Boys)*

Name of Winners: (In Capital Letters Only)

Sr.No	Name	Branch	Year	Mob. No.
1	VIPUL HITIN PIMPLE	CIVIL	B.E	9011799978
2	SUMIT SANJAY PAWASKAR	MECH	TE	7020246052
3				
4				
5				
6				
7				
8				
9				
10				
11				
12				
13				
14				



*S. S. Figueira*  
Head

Prof.

Head

Prof.

Received by:

P.D Head

PRINCIPAL

THEEM COLLEGE OF ENGINEERING  
At Village Betegaon, Boisar Chilhar Road  
Boisar (East) Tal. & Dist. Palghar - 401 201





H. J. THIM TRUST'S  
**Theem College of Engineering, Boisar**

Approved by AICTE (New Delhi) Government of Maharashtra & DTE  
Affiliated to University of Mumbai Est.: - 2009 - 2010

# Jashn-e-Theem 2022

## List of Winner of Group Event

Category: Technical/ Sports/ Cultural (Tick any one)

Date:

Name of Event: Badminton double Boys

Kindly award Certificate and Medals/ Trophies to the following students.

Name of Winners: (In Capital Letters Only)

1	V	I	P	U	L	N	I	T	I	N	P	I	M	P	L	E				
2	S	U	M	I	T	S	A	N	J	A	Y	P	A	W	A	S	K	A	R	
3																				
4																				
5																				
6																				
7																				
8																				
9																				
10																				
11																				
12																				
13																				
14																				



Event in charge  
Prof. Zulfiqar Head

Received by:  
Prof.

PRINCIPAL Head  
THEEM COLLEGE OF ENGINEERING  
At Village Betegaon, Boisar Chikhar Road  
Boisar (East) Tal. & Dist. Palghar - 401 201



H. J. THIM TRUST'S  
**Theem College of Engineering, Boisar**

Approved by AICTE (New Delhi) Government of Maharashtra & DTE  
Affiliated to University of Mumbai Est.: - 2009 - 2010

Badminton ~~or~~ Double (Boys)

Name of 1<sup>st</sup> Runner-Up: (In Capital Letters Only)

Sr.No	Name	Branch	Year	Mob. No.
1	ARCHIS RANJITSAVE	IT	SE	9359963604
2	ADITYA JAGENDRAGUPTA	IT	SE	
3				
4				
5				
6				
7				
8				
9				
10				
11				
12				
13				
14				



Prof. Zee Anwar Head

Received by: Prof.

**PRINCIPAL**  
THEEM COLLEGE OF ENGINEERING  
At. Village Betegaon, Boisar Chithar Road  
Boisar (East) Tal. & Dist. Palohar - 401 201







H. J. THIM TRUST'S  
**Theem College of Engineering, Boisar**

Approved by AICTE (New Delhi) Government of Maharashtra & DTE  
Affiliated to University of Mumbai Est.: - 2009 - 2010

*Badminton Bowler Boy*

Name of 2<sup>nd</sup> Runner-Up: (In Capital Letters Only)

Sr.No	Name	Branch	Year	Mob. No.
1	KAIVALYA MAHESH KAWLI	AUTO	BE	8369769221
2	JITEN NAGENDRA DAS	MECH	TE	
3				
4				
5				
6				
7				
8				
9				
10				
11				
12				
13				
14				

**PRINCIPAL**  
THEEM COLLEGE OF ENGINEERING  
At. Village Bilegaon, Boisar Chillar Road  
Boisar (East) Tal. & Dist. Palohar - 401 201

Event Incharge  
Prof. *Zulfiqar Ahmad*



Prof. \_\_\_\_\_ Head

Received by:  
Prof. \_\_\_\_\_



H. J. THIM TRUST'S

# Theem College of Engineering, Boisar

Approved by AICTE (New Delhi) Government of Maharashtra & DTE  
Affiliated to University of Mumbai Est.: - 2009 - 2010

## Jashn-e-Theem 2022

### List of Winner of Group Event

Category: Technical/ Sports/ Cultural (Tick any one)

Date: 24/3/2022

Name of Event: Badminton double boys

Kindly award Certificate and Medals/ Trophies to the following students.

Name of 2<sup>nd</sup> Runner-Up: (In Capital Letters Only)

1	K	A	I	V	A	L	Y	A	M	A	H	E	S	H	K	A	W	L	I				
2	J	I	T	E	N	N	A	G	E	N	D	R	A	D	A	S							
3																							
4																							
5																							
6																							
7																							
8																							
9																							
10																							
11																							
12																							
13																							
14																							

Event Incharge  
Prof. Zulfiqar

Head  
Prof. \_\_\_\_\_

Received by:  
Prof. \_\_\_\_\_

P.D Head  
Prof. \_\_\_\_\_



PRINCIPAL  
THEEM COLLEGE OF ENGINEERING  
At, Village Betegaon, Boisar Chithar Road  
Boisar (East) Tal. & Dist. Palghar - 40









H. J. THIM TRUST'S

## THEEM COLLEGE OF ENGINEERING

### NOTICE

Date: 05/03/2022

All the students are hereby informed that, the college level Chess (Boys and Girls) events will be starting from 21 Mar 2022. All the interested students should enroll your name as an Individual or Group on or before 19 Mar 2022.

(Entry fees for Individual are Rs 10 )

Following Students Coordinators:-

ARPIT (SE COMP)

SHAKIR (SE COMP)

HINMAVE (SE IT)

ANKITA (TE IT)

#### Staff Coordinator

Prof. Kazi Azimuddin

#### Sport Coordinator

Prof. Harshal Ahire

Prof. Ayaz Bagwan.



  
PRINCIPAL  
THEEM COLLEGE OF ENGINEERING  
At. Village Biregason, Bolar Chitkar Tal. & Dist. Palghar - 410 202



# JASHN-E-THEEM 2022

## CHESS DAY

### 21 MAR 2022



**Student Coordinators**

**Arpit (SE COMP)**

**Hinmaye (SE IT)**

**Shakir (SE Comp)**

**Ankita (TE IT)**

**Staff Coordinators**

**Prof. Kazi Azimuddin (9579850730)**

**PRINCIPAL**

**THEEM COLLEGE OF ENGINEERING**  
St. Village Behgaon, Bolser Chitwan P.  
Pisar (East) Tal. & Dist. Palpa-17









H. J. THIM TRUST'S

## THEEM COLLEGE OF ENGINEERING

### NOTICE

Date: 15/03/2022

All the students are hereby informed that, the college level Carrom Singles and Doubles events will be starting from 21 Mar 2022. All the interested students should enroll your name as an Individual or Group on or before 18 Mar 2022.

(Entry fees for Individual are Rs 10 and for Group /Team is Rs 20.)

Following Students Coordinators:-

SHALAL (SE IT)

USMAN (SE AIML)

ARPIT (SE COMP)

CHINMAYI (BE MECH)

#### Staff Coordinator

Prof. Moinuddin Ansari

#### Sport Coordinator

Prof. Harshal Ahire

Prof. Ayaz Bagwan.



  
**PRINCIPAL**  
THEEM COLLEGE OF ENGINEERING  
At, Village Belegaon, Boisar Chithar R.  
Boisar (East) Tal. & Dist. Palohar - 40

**JASHN-E-THEEM 2022**

# **CARROM DAY**

**21 MAR 2022**



**Student Coordinators**

**Shalal (SE IT)**

**Arpit (SE COMP)**

**Usman (SE AIML)**

**Chinmayi (BE MECH)**

**Staff Coordinators**

**Prof. Moinuddin Ansari (8275589497)**

**PRINCIPAL**

**THEEM COLLEGE OF ENGINEERING**  
At Village Betegaon, Bolsar Chikhar P.  
Bolsar (East) Tal. & Dist. Palehar - 81



H. J. THIM TRUST'S

# Theem College of Engineering, Boisar

Approved by AICTE (New Delhi) Government of Maharashtra & DTE  
Affiliated to University of Mumbai Est.: - 2009 - 2010

Carrom Doubles - Girls

Name of Winners: (In Capital Letters Only)

Sr.No	Name	Branch	Year	Mob. No.
1	Diksha Satave	EXTC	B.E	
2	Chinmayi Satave	EXTC	B.E	
3				
4				
5				
6				
7				
8				
9				
10				
11				
12				
13				
14				



Prof.  Head

Received by:  
Prof.

  
Prof. P.D. Head  
PRINCIPAL  
THEEM COLLEGE OF ENGINEERING  
At. Village Betegaon, Boisar Chithar Road  
Boisar (East) Tal. & Dist. Palghar - 401 205





# H. J. THIM TRUST'S Theem College of Engineering, Boisar

Approved by AICTE (New Delhi) Government of Maharashtra & DTE  
Affiliated to University of Mumbai Est.: - 2009 - 2010

Carrom Doubles Girls

Name of  Runner-Up: (In Capital Letters Only)

Sr.No	Name	Branch	Year	Mob. No.
1	Jannat Shaikh	Comp	TE	
2	Jayruti Patil	Comp	TE	
3				
4				
5				
6				
7				
8				
9				
10				
11				
12				
13				
14				

Event Incharge

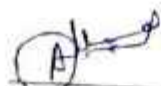

  
Prof. \_\_\_\_\_ Head

Received by:  
Prof.



PRINCIPAL  
P.D Head  
THEEM COLLEGE OF ENGINEERING  
At. Village Betegaon, Boisar Chithar Road  
Boisar (East) Tal. & Dist. Palghar



H. J. THIM TRUST'S

# Theem College of Engineering, Boisar

Approved by AICTE (New Delhi) Government of Maharashtra & DTE  
Affiliated to University of Mumbai Est.: - 2009 - 2010

Corroto Doubles Boys

Name of Winners: (In Capital Letters Only)

Sr.No	Name	Branch	Year	Mob. No.
1	Usman Patel	mech	TE	
2	Maaz Shaikh	mech	TE	
3				
4				
5				
6				
7				
8				
9				
10				
11				
12				
13				
14				



  
Prof. Head

  
Received by: **PRINCIPAL** Head  
Prof. THEEM COLLEGE OF ENGINEERING  
At Village Betegaon, Boisar, Tal. Boisar, Dist. Palghar - 401 302



# H. J. THIM TRUST'S Theem College of Engineering, Boisar

Approved by AICTE (New Delhi) Government of Maharashtra & DTE  
Affiliated to University of Mumbai Est.: - 2009 - 2010

Carrom Doubles Boys

Name of <sup>1<sup>st</sup></sup> Runner-Up: (In Capital Letters Only)

Sr.No	Name	Branch	Year	Mob. No.
1	Chirag Patil	Civil	SE	
2	Aarif Shaitch	Civil	SE	
3				
4				
5				
6				
7				
8				
9				
10				
11				
12				
13				
14				



  
Prof. \_\_\_\_\_ Head

  
Received by \_\_\_\_\_  
PRINCIPAL  
THEEM COLLEGE OF ENGINEERING  
At. Village Betegaon, Post Chithar Road,  
Boisar (East) Tal. & Dist. Palghar - 401 501









H. J. THIM TRUST'S

# Theem College of Engineering, Boisar

Approved by AICTE (New Delhi) Government of Maharashtra & DTE  
Affiliated to University of Mumbai Est.: - 2009 - 2010

## Jashn-e-Theem 2022

### List of Winner of Individual Event

Category: Technical/ Sports/ Cultural (Tick any one)

Date:

Name of Event: Carrom Boy Single

Kindly award Certificate and Medals/ Trophies to the following students.

Name of Winner: (In Capital Letters Only)

SHALAT MANJALKAR

Name of Winner

Branch: IT Year: TE Mob. No. \_\_\_\_\_

Name of 1<sup>st</sup> Runner-Up: In Capital Letters Only

AARPI T SHARMA

Name of 1st Runner-Up

Branch: Mech Year: BE Mob. No. \_\_\_\_\_

Name of 2<sup>nd</sup> Runner-Up: In Capital Letters Only

\_\_\_\_\_

Name of 2nd Runner-Up

Branch: \_\_\_\_\_ Year: \_\_\_\_\_ Mob. No. \_\_\_\_\_



Event Incharge  
Prof.

A. H. S.  
Prof. Head

Received by:  
Prof.

[Signature]  
PRINCIPAL  
THEEM COLLEGE OF ENGINEERING  
At. Village Betegaon, Boisar Chithar Road  
Boisar (East) Tal. & Dist. Palghar

P.D Head  
Prof.





H. J. THIM TRUST'S

## THEEM COLLEGE OF ENGINEERING

### NOTICE

Date: 18/03/2022

All the students are hereby informed that, the college level Athletics (Boys and Girls) events will be starting from 24<sup>th</sup> March 2022. All the interested students should enroll your name as an Individual or Group on or before 21<sup>st</sup> March 2022.

(Entry fees for Individual are Rs 10 and for Group /Team is Rs 40.)

Following Coordinators:-

MAAZ (TE COMP)

DANISH (SE AIML)

ANISH (TE COMP)

RITVIK(TE AIML)

#### Staff Coordinator

Prof. N G Hiremath

Prof. Harshad R.

Mr. Neetishkumar

Mrs. Sayali Patil

Mrs. Surekha Attarde

#### Sport Coordinator

Prof. Harshal Ahire

Prof. Ayaz Bagwan.



  
PRINCIPAL  
THEEM COLLEGE OF ENGINEERING  
At Village Betogaon, Boisar Chitthar Road  
Boisar (East) Tal. & Dist. Palghar - 425 002

**JASHN-E-THEEM 2022**

# **ATHLETICS DAY**

**24th MAR 2022**



**Student Coordinators**

**Maaz (TE COMP)**

**Anish (TE COMP)**

**Danish (SE AIML)**

**Ritvik (TE AIML)**

**Staff Coordinators**

**Prof N G Hiremath (8880106375)**

**Prof Harshad R**

**PRINCIPAL**

**THEEM COLLEGE OF ENGINEERING**  
St. Village Betegaon, Bolser Chikher Road,  
Pisar (East) Tal. & Dist. Palghar - 407 501







H. J. THIM TRUST'S

# Theem College of Engineering, Boisar

Approved by AICTE (New Delhi) Government of Maharashtra & DTE  
Affiliated to University of Mumbai Est.: - 2009 - 2010

## Jashn-e-Theem 2022

### List of Winner of Individual Event

Category: Technical/ Sports/ Cultural (Tick any one)

Date: 24/03/2022

Name of Event: Javelin Throw (Boys)

Kindly award Certificate and Medals/ Trophies to the following students.

Name of Winner: (In Capital Letters Only)

SHAYESH WAGHMARE  
Name of Winner

Branch: Mechanical Year: B.E Mob. No. 8530466806

Name of 1<sup>st</sup> Runner-Up: In Capital Letters Only)

RIZWAN KHAN  
Name of 1st Runner-Up

Branch: I.T Year: T.E Mob. No. 8080440468

Name of 2<sup>nd</sup> Runner-Up: In Capital Letters Only)

DANINA DABHAWALA AMPAD  
Name of 2nd Runner-Up

Branch: MECHANICAL Year: S.Y. Mob. No. \_\_\_\_\_



\_\_\_\_\_  
Prof. Head Received by:  
Prof. Prof.

\_\_\_\_\_  
P.D. Head  
Prof.

**PRINCIPAL**  
THEEM COLLEGE OF ENGINEERING  
At Village Betegaon, Boisar Chithar Road  
Boisar (East) Tal. & Dist. Palghar





H. J. THIM TRUST'S

# Theem College of Engineering, Boisar

Approved by AICTE (New Delhi) Government of Maharashtra & DTE  
Affiliated to University of Mumbai Est.: - 2009 - 2010

## Jashn-e-Theem 2022

### List of Winner of Individual Event

Category: Technical/ Sports/ Cultural (Tick any one)

Date: 24/03/22

Name of Event: Discuss (Girls)

Kindly award Certificate and Medals/ Trophies to the following students.

Name of Winner: (In Capital Letters Only)

SAMRUDDHI NATAK  
Name of Winner

Branch: IT Year: B.E Mob. No. \_\_\_\_\_

Name of 1<sup>st</sup> Runner-Up: In Capital Letters Only)

ALISHA BHASKAR  
Name of 1st Runner-Up

Branch: computer Year: IT Mob. No. \_\_\_\_\_

Name of 2<sup>nd</sup> Runner-Up: In Capital Letters Only)

MANSI PATHARE  
Name of 2nd Runner-Up

Branch: computer Year: SE Mob. No. \_\_\_\_\_



Event Incharge  
Prof. V. K. Kulkarni

Head  
Prof. \_\_\_\_\_

Received by  
[Signature]  
Prof. \_\_\_\_\_

P.D Head  
Prof. \_\_\_\_\_

PRINCIPAL  
THEEM COLLEGE OF ENGINEERING  
At. Village Betegaon, Boisar Chitthar R.  
Boisar (East) Tal. & Dist. Palghar - 401





H. J. THIM TRUST'S

# Theem College of Engineering, Boisar

Approved by AICTE (New Delhi) Government of Maharashtra & DTE

Affiliated to University of Mumbai Est.: - 2009 - 2010

## Jashn-e-Theem 2022

### List of Winner of Individual Event

Category: Technical/ Sports/ Cultural (Tick any one)

Date: 24/03/2022

Name of Event: DISCUSS THROM (BOYS)

Kindly award Certificate and Medals/ Trophies to the following students.

Name of Winner: (In Capital Letters Only)

JOSHIL BARDI  
Name of Winner

Branch: Mech Year: SE Mob. No. 9960028308

Name of 1<sup>st</sup> Runner-Up: In Capital Letters Only)

NITESH GUPTA  
Name of 1st Runner-Up

Branch: \_\_\_\_\_ Year: \_\_\_\_\_ Mob. No. 8779722702

Name of 2<sup>nd</sup> Runner-Up: In Capital Letters Only)

SUSHANT PATIL  
Name of 2nd Runner-Up

Branch: Electrical Year: \_\_\_\_\_ Mob. No. \_\_\_\_\_



Prof. \_\_\_\_\_ Head

Received by: \_\_\_\_\_ Prof.

PRINCIPAL  
THEEM COLLEGE OF ENGINEERING  
At: Village Bilegaon, Boisar Chikhar Road  
Boisar (East) Tal. & Dist. Palghar









H. J. THIM TRUST'S

# Theem College of Engineering, Boisar

Approved by AICTE (New Delhi) Government of Maharashtra & DTE  
Affiliated to University of Mumbai Est.: - 2009 - 2010

Name of 1<sup>st</sup> Runner-Up: (In Capital Letters Only)

Sr.No	Name	Branch	Year	Mob. No.
1	ALISHA SHAIKH	Comp	T.E	
2	TEJAL PATIL	Comp	TE	
3	MANSI GHARAT	Comp		
4	SWARUPA SARVANKAR	Comp	B.E	
5				
6				
7				
8				
9				
10				
11				
12				
13				
14				



Prof. \_\_\_\_\_ Head

Received by:  
Prof.

  
P.D Head  
PRINCIPAL

THEEM COLLEGE OF ENGINEERING  
At. Village Betegaon, Boisar Chiltar Rd.  
Boisar (East) Tal. & Dist. Palghar - 401 301





H. J. THIM TRUST'S  
**Theem College of Engineering, Boisar**

Approved by AICTE (New Delhi) Government of Maharashtra & DTE  
Affiliated to University of Mumbai Est.: - 2009 - 2010

Relay (Boys)

Name of  Runner-Up: (In Capital Letters Only)

Sr.No	Name	Branch	Year	Mob. No.
1	MAAR SHAIKH			
2	MAVIYA SHAIKH			
3	RUFFI FAKKI	Comp	TE	
4	AMAN AHMED			
5				
6				
7				
8				
9				
10				
11				
12				
13				
14				



Event Incharge  
Prof.

Prof. \_\_\_\_\_ Head

Received by:  
Prof.

P.D. Head  
Prof. **PRINCIPAL**  
THEEM COLLEGE OF ENGINEERING  
At Village Betegaon, Boisar Chitkar Road  
Boisar (East) Tal. & Dist. Palghar - 401 301







# H. J. THIM TRUST'S Theem College of Engineering, Boisar

Approved by AICTE (New Delhi) Government of Maharashtra & DTE  
Affiliated to University of Mumbai Est.: - 2009 - 2010

Relay (Boys)

Name of Winners: (In Capital Letters Only)

Sr.No	Name	Branch	Year	Mob. No.
1	ANIRVA ANHARE	MECH	57	8010049259
2	VED PURANDARE	ELEM	57	9665472140
3	VIROJ SANKHE	ELEC	57	8010504945
4	VRUSHANT DHANPAL	ELE.	57	9322849567
5				
6				
7				
8				
9				
10				
11				
12				
13				
14				



Prof. \_\_\_\_\_ Head Received by:  
Prof. \_\_\_\_\_

*(Signature)*  
Prof. \_\_\_\_\_

PRINCIPAL

THEEM COLLEGE OF ENGINEERING  
At. Village Betegaon, Boisar Chilhar R-  
Boisar (East) Tal. & Dist. Palghar - 40









H. J. THIM TRUST'S

# Theem College of Engineering, Boisar

Approved by AICTE (New Delhi) Government of Maharashtra & DTE  
Affiliated to University of Mumbai Est.: - 2009 - 2010

## Jashn-e-Theem 2022

### List of Winner of Individual Event

Category: Technical/ Sports/ Cultural (Tick any one)

Date: 24/03/2022

Name of Event: 100 m running (Girls)

Kindly award Certificate and Medals/ Trophies to the following students.

Name of Winner: (In Capital Letters Only)

MAHEK SHAIKH

Name of Winner

Branch: COMPUTER Year: TE Mob. No. \_\_\_\_\_

Name of 1<sup>st</sup> Runner-Up: In Capital Letters Only

MARIYA SIDDIQUI

Name of 1st Runner-Up

Branch: COMPUTER Year: TE Mob. No. \_\_\_\_\_

Name of 2<sup>nd</sup> Runner-Up: In Capital Letters Only

ZOHA SHAIKH

Name of 2nd Runner-Up

Branch: Computer Year: S.E Mob. No. \_\_\_\_\_

*Smruti*

Event Incharge  
Prof. Abd maly Prof.

Head  
Prof. [Signature] Received by:

P.D Head  
Prof.



PRINCIPAL  
THEEM COLLEGE OF ENGINEERING  
At Village Betegaon, Boisar Chikhar P.  
Boisar (East) Tal. & Dist. Palghar.

## Ramp burn.

M/s Theem - Pragati Kambdi  
Mr Theem - Anwes Chauhan

~~3<sup>rd</sup>~~ prize - Rasika Roshivate  
2<sup>nd</sup> prize - Rahul Rana  
1<sup>st</sup> prize - Ritvik Mishra



A handwritten signature in blue ink, appearing to be 'S. S. S.', written over a horizontal line.

PRINCIPAL  
THEEM COLLEGE OF ENGINEERING  
At, Village Betnagaon, Bolisar Chilhara R.  
Bolisar (East) Tal. & Dist. Patohara





H. J. THIM TRUST'S

## THEEM COLLEGE OF ENGINEERING

### NOTICE

Date: 12/03/2022

All the students are hereby informed that, the college level Hand Writing Competition (Boys and Girls) event will be starting from 22 March 2022. All the interested students should enroll your name as an Individual or Group on or before 18<sup>rd</sup> March 2022.

(Entry fees for Individual are Rs 10 and for Group /Team is Rs 30.)

Following Coordinators:-

SWARUPA (TE IT)

MITRI (SE ELE)

HIMANSHI (SE COMP)

**Staff Coordinator**

Prof. Priyanka Patil

**Cultural Coordinator**

Prof. Arbiya Shaikh

Prof. Rosy Bhoi



  
**PRINCIPAL**  
THEEM COLLEGE OF ENGINEERING  
At Village Betegaon, Boisar Chitlihar Road  
Boisar (East) Tal. & Dist. Palghar - 425 102

# JASHN-E-THEEM 2022 HANDWRITING COMPETITION

22 MAR 2022



**Student Coordinators**

**Swarupa (TE IT)**

**Mitri (SE ELE)**

**Himanshi (SE Comp)**

**Staff Coordinators**

**Prof. Priyanka PATIL**

**PRINCIPAL**

THEEM COLLEGE OF ENGINEERING  
At Village Belegaon, Borsar Chittran B...  
Borsar (East) Tal. & Dist. Palenw...





H. J. THEEM TRUST'S  
**Theem College of Engineering, Boisar**

Approved by AICTE (New Delhi) Government of Maharashtra & DTE  
Affiliated to University of Mumbai Est.: - 2009 - 2010

# Jashn-e-Theem 2022

## List of Winner of Individual Event

Category: Technical/ Sports/ Cultural (Tick any one)

Date: 22/03/2022

Name of Event: HAND WRITING COMPETITION (MARATHI/HINDI)

Kindly award Certificate and Medals/ Trophies to the following students.

Name of Winner: (In Capital Letters Only)

S W A R U P A S A R V A N K A R  
Name of Winner

Branch: COMPUTER Year: BE Mob. No. 8625095050

Name of 1<sup>st</sup> Runner-Up: In Capital Letters Only)

M A I T R A Y E E V A R T A K  
Name of 1st Runner-Up

Branch: I.T Year: TE Mob. No. 7038234985

Name of 2<sup>nd</sup> Runner-Up: In Capital Letters Only)

M A N S I R A U T  
Name of 2nd Runner-Up

Branch: CIVIL Year: B.E Mob. No. 9022443899

Event Incharge  
Prof. Kajal A.S.

SP  
(Shaikh Sajid Adik)

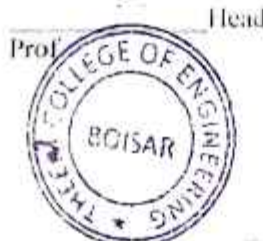

Received by:  
Prof.

[Signature]  
- P.D Head  
Prof.  
**PRINCIPAL**

**THEEM COLLEGE OF ENGINEERING**  
At Village Betegaon, Boisar Chithar Road,  
Boisar (East) Tal. & Dist. Palohar - 401 301







H. J. THIM TRUST'S

# Theem College of Engineering, Boisar

Approved by AICTE (New Delhi) Government of Maharashtra & DTE  
Affiliated to University of Mumbai Est.: - 2009 - 2010

## Jashn-e-Theem 2022

### List of Winner of Individual Event

Category: Technical/  Sports/ Cultural (Tick any one)

Date: 22/03/2022

Name of Event: HANDWRITING COMPETITION (ENGLISH)

Kindly award Certificate and Medals/ Trophies to the following students.

Name of Winner: (In Capital Letters Only)

S O F I Y A A L T A F S H A I K H  
Name of Winner

Branch: I.T Year: B.E Mob. No. 9967846562

Name of 1<sup>st</sup> Runner-Up: In Capital Letters Only)

M O H A M M A D A R I F S . A S A Y E D  
Name of 1st Runner-Up

Branch: COMPUTER Year: F.Y Mob. No. 9422484312

Name of 2<sup>nd</sup> Runner-Up: In Capital Letters Only)

S A L O N I S U D H A K A R T A N D E L  
Name of 2nd Runner-Up

Branch: I.T Year: B.E Mob. No. 9112183828

Event Incharge  
Prof. *(Signature)*



Head

Prof.

Received by:

P.D Head

*(Signature)*  
PRINCIPAL

THEEM COLLEGE OF ENGINEERING  
At. Village Betegaon, Boisar Chilhar Rd.  
Boisar (East) Tal. & Dist. Palghar - 40

*(Signature)*  
(Shaikh Sajid A.K)







H. J. THEM TRUST'S  
**Theem College of Engineering, Boisar**

Approved by AICTE (New Delhi) Government of Maharashtra & DTE  
Affiliated to University of Mumbai Est.: - 2009 - 2010

em C  
Approved

POSTER/DRAWING

Name of 2<sup>nd</sup> Runner-Up: (In Capital Letters Only)

Sr.No	Name	Branch	Year	Mob. No.
1	SURAJ YADAV	IT	TE	9137127927
2				
3				
4				
5				
6				
7				
8				
9				
10				
11				
12				
13				
14				



Prof. \_\_\_\_\_ Head

Received by:   
Prof. \_\_\_\_\_ P.D Head

**PRINCIPAL**  
THEEM COLLEGE OF ENGINEERING  
At. Village Betegaon, Boisar Chilhar Road  
Boisar (East) Tal. & Dist. Palohar - 401 202



H. J. THIM TRUST'S  
**Theem College of Engineering, Boisar**

Approved by AICTE (New Delhi) Government of Maharashtra & DTE  
Affiliated to University of Mumbai Est.: - 2009 - 2010

Name of 1<sup>st</sup> Runner-Up: (In Capital Letters Only)

POSTER / DRAWING

Sr.No	Name	Branch	Year	Mob. No.
1	MANJIREB PATIL	COMP	SE	9665068550
2	SHUBHAM NAYPURE	COMP	SE	9373471068
3				
4				
5				
6				
7				
8				
9				
10				
11				
12				
13				
14				

Event Incharge  
Prof.



Head  
Prof.

Received by:  
Prof.

**PRINCIPAL** Head  
THEEM COLLEGE OF ENGINEERING  
At. Village Betegaon, Boisar Chithar Road  
Boisar (East) Tal. & Dist. Palohar - 40



H. J. THIM TRUST'S  
**Theem College of Engineering, Boisar**

Approved by AICTE (New Delhi) Government of Maharashtra & DTE  
Affiliated to University of Mumbai Est.: - 2009 - 2010

# Jashn-e-Theem 2022

## List of Winner of Group Event

Category: Technical/ Sports/ Cultural (Tick any one)

Date: 22/03/22

Name of Event: POSTER / DRAWING

Kindly award Certificate and Medals/ Trophies to the following students.

Name of 1<sup>st</sup> Runner-Up: (In Capital Letters Only)

1	M	A	N	J	I	R	E	E	P	A	T	I	L	} group
2	S	H	U	B	H	A	M	N	A	U	P	U	R	
3														
4														
5														
6														
7														
8														
9														
0														
1														
2														
3														
4														

Event Incharge  
Prof.



Head

Prof.

Received by:

P.D Head

PRINCIPAL

THEEM COLLEGE OF ENGINEERING

At Village Betegaon, Boisar Chitkar Road

Boisar (East) Tal. & Dist. Palghar - 401 202





H. J. THIM TRUST'S

## THEEM COLLEGE OF ENGINEERING

### NOTICE

Date: 17/03/2022

All the students are hereby informed that, the college level Cultural Days Celebration (Boys and Girls) events will be starting from 21<sup>th</sup> March 2022. All the interested students should enroll your name as an Individual or Group on or before 19<sup>rd</sup> March 2022.

(Entry fees for Individual are Rs 10 and for Group /Team is Rs 40.)

Following Coordinators:-

SOFIA (TE IT)

MAITRI(SE COMP)

NILESH (SE MECH)

VIPUL(TE ELE)

#### Staff Coordinator

Prof. Ketaki Patil

Prof. Jagruti More

Prof. Monika Pathare

Prof Shahegul

#### Cultural Coordinator

Prof. Arbiya Shaikh

Prof. Rosy Bhoi



PRINCIPAL  
THEEM COLLEGE OF ENGINEERING  
At. Village Betegaon, Bosisar Chikhat Road,  
Bosisar (East) Tal. & Dist. Palghar - 425 102

# JASHN-E-THEEM 2022

## CULTURAL DAYS CELEBRATION

21 MAR 2022



### Student Coordinators

Sofia (TE IT)

Maitri (SE Comp)

Nilesh (SE Mech)

Vipul (TE ELE)

### Staff Coordinators

Prof Ketaki Patil

Prof Jagruthi More

PRINCIPAL

THEEM COLLEGE OF ENGINEERING

Prof Monika Pathare

Prof Shahegul





H. J. THIM TRUST'S  
**Theem College of Engineering, Boisar**

Approved by AICTE (New Delhi) Government of Maharashtra & DTE  
Affiliated to University of Mumbai Est.: - 2009 - 2010

# Jashn-e-Theem 2022

## List of Winner of Individual Event

Category: Technical/ Sports/ Cultural (Tick any one)

Date: 21-03-22

Name of Event: TRADITIONAL DAY (GIRLS)

Kindly award Certificate and Medals/ Trophies to the following students.

Name of Winner: (In Capital Letters Only)

S O F I A S H A I K H

Name of Winner

Branch: INFORMATION Year: B.E Mob. No. \_\_\_\_\_  
TECHNOLOGY  
(DEURFE)

Name of 1<sup>st</sup> Runner-Up: In Capital Letters Only)

M A I T R A Y E E V A R T A K

Name of 1st Runner-Up

Branch: INFORMATION Year: T.E Mob. No. \_\_\_\_\_  
TECHNOLOGY  
(DEURFE)

Name of 2<sup>nd</sup> Runner-Up: In Capital Letters Only)

Name of 2nd Runner-Up

Branch: \_\_\_\_\_ Year: \_\_\_\_\_ Mob. No. \_\_\_\_\_



Prof. \_\_\_\_\_ Head

Received by:  
Prof. \_\_\_\_\_

P.D. Head  
**PRINCIPAL**  
THEEM COLLEGE OF ENGINEERING  
At, Village Belegaon, Boisar Chiltar Rd.  
Boisar (East) Tal. & Dist. Palghar - 401 201









H. J. THIM TRUST'S

## THEEM COLLEGE OF ENGINEERING

### NOTICE

Date: 12/03/2022

All the students are hereby informed that, the college level Mehandi event will be starting from 22 March 2022. All the interested students should enroll your name as an Individual or Group on or before 18<sup>rd</sup> March 2022.

(Entry fees for Individual are Rs 10 and for Group /Team is Rs 20.)

Following Coordinators:-

SWARUPA (TE IT)

MITRI (SE ELE)

HIMANSHI (TE COMP)

#### Staff Coordinator

Prof. Jagruti More

Prof. Jayashree

Prof Jyoti Katela

#### Cultural Coordinator

Prof. Arbiya Shaikh

Prof. Rosy Bhoi



  
PRINCIPAL  
THEEM COLLEGE OF ENGINEERING  
At. Village Betgaon, Bosisar Chitthar Road,  
Bosisar (East) Tal. & Dist. Palohar - AP - 522 202





H. J. THIM TRUST'S  
**Theem College of Engineering, Boisar**

Approved by AICTE (New Delhi) Government of Maharashtra & DTE  
 Affiliated to University of Mumbai Est.: - 2009 - 2010

# Jashn-e-Theem 2022

## List of Winner of Individual Event

Category: Technical/ Sports/ Cultural (Tick any one)

Date: 21-03-2022

Name of Event: MEHENDI COMPETITION

Kindly award Certificate and Medals/ Trophies to the following students.

Name of Winner: (In Capital Letters Only)

P R I Y A N K A   B H I D E  
 Name of Winner

Branch: COMPUTER   Year: 5-Y   Mob. No. 8010973391  
(DIPLOMA)

Name of 1<sup>st</sup> Runner-Up: In Capital Letters Only

A N K I T A  
 Name of 1st Runner-Up

Branch: COMPUTER   Year: B.E   Mob. No. 9561471998  
(DEGREE)

Name of 2<sup>nd</sup> Runner-Up: In Capital Letters Only

D H A N A S H R E E   D H E K A N E  
 Name of 2nd Runner-Up

Branch: INFORMATION   Year: \_\_\_\_\_   Mob. No. 7502333666  
TECHNOLOGY

Event Incharge  
 Prof. \_\_\_\_\_

Head  
 Prof. \_\_\_\_\_

Received by:  
 Prof. \_\_\_\_\_

P.D. Head  
 Prof. \_\_\_\_\_



# JASHN-E-THEEM 2022

## RANGOLI COMPETITION

22 Mar 2022



**Student Coordinators**

**Swarupa (TE IT)**

**Himanshi (SE Comp)**

**Mitri (SE ELE)**

**Staff Coordinators**

**Prof Jagruti More**

**Prof Jyoti katela**

**PRINCIPAL**

**THEEM COLLEGE OF ENGINEERING**  
St. Village Betegaon, Boisar Chitwan Road  
Boisar (East) Tal. & Dist. Palanpur



H. J. THIM TRUST'S

## THEEM COLLEGE OF ENGINEERING

### NOTICE

Date: 12/03/2022

All the students are hereby informed that, the college level Rangoli event will be starting from 22 March 2022. All the interested students should enroll your name as an Individual or Group on or before 18<sup>rd</sup> March 2022.

(Entry fees for Individual are Rs 10 and for Group /Team is Rs 20.)

Following Coordinators:-

SWARUPA (TE IT)

MITRI (SE ELE)

HIMANSHI (SE COMP)

#### Staff Coordinator

Prof. Jagruti More

Prof. Jayashree

Prof Jyoti Katela

#### Cultural Coordinator

Prof. Arbiya Shaikh

Prof. Rosy Bhoi



**PRINCIPAL**  
THEEM COLLEGE OF ENGINEERING  
At. Village Betegaon, Boisar Chilhar Road  
Boisar (East) Tal. & Dist. Palahar - 401 202





H. J. THIM TRUST'S  
**Theem College of Engineering, Boisar**

Approved by AICTE (New Delhi) Government of Maharashtra & DTE  
Affiliated to University of Mumbai Est.: - 2009 - 2010

# Jashn-e-Theem 2022

## List of Winner of Individual Event

Category: Technical/ Sports/ Cultural (Tick any one)

Date: 21-03-22

Name of Event: RANOLI COMPETITION

Kindly award Certificate and Medals/ Trophies to the following students.

Name of Winner: (In Capital Letters Only)

TANVESH RAJU NAIK  
Name of Winner

Branch: MELHANICAL Year: B.E Mob. No. 9552980862  
(DEGREE)

Name of 1<sup>st</sup> Runner-Up: In Capital Letters Only

KIRAN SUNDKAR  
Name of 1st Runner-Up

Branch: ELECTRICAL Year: B.E Mob. No. 8779635309  
(DEGREE)

Name of 2<sup>nd</sup> Runner-Up: In Capital Letters Only

MANAST GHARAT  
Name of 2nd Runner-Up

Branch: COMPUTER Year: T.E Mob. No. 7397903247  
(DEGREE)

Event Incharge  
Prof.

Head  
Prof.

Received by:  
Prof.

P.D. Head  
Prof.

PRINCIPAL

THEEM COLLEGE OF ENGINEERING  
At. Village Betegaon, Boisar Chikhar Road  
Boisar (East) Tal. & Dist. Palghar - 401 301





H. J. THIM TRUST'S

## THEEM COLLEGE OF ENGINEERING

### NOTICE

Date: 12/03/2022

All the students are hereby informed that, the college level Nail Art Competition event will be starting from 22 March 2022. All the interested students should enroll your name as an Individual or Group on or before 18<sup>rd</sup> March 2022.

(Entry fees for Individual are Rs 10 and for Group /Team is Rs 20.)

Following Coordinators:-

SWARUPA (TE IT)

MITRI (SE ELE)

HIMANSHI (SE COMP)

#### Staff Coordinator

Prof. Jagruti More

Prof. Jayashree

Prof Jyoti Katela

#### Cultural Coordinator

Prof. Arbiya Shaikh

Prof. Rosy Bhoi



**PRINCIPAL**  
THEEM COLLEGE OF ENGINEERING  
At. Village Betegaon, Boisar Chilar Road  
Boisar (East) Tal. & Dist. Palohar - 401 202

# JASHN-E-THEEM 2022

## NAIL ART COMPETITION

### 22 MAR 2022



**Student Coordinators**

**Swarupa (TE IT)**

**Mitre (SE ELE)**

**Himanshi (SE Comp)**

**Staff Coordinators**

**Prof Jagruti More**

**Prof Jyoti katela**

**PRINCIPAL**

**THEEM COLLEGE OF ENGINEERING**  
St. Village, Betegaon, Bolser, Chhota Bazar  
Dist. East Tal. & Dist. Palshahi







H. J. THIM TRUST'S

## THEEM COLLEGE OF ENGINEERING

### NOTICE

Date: 12/03/2022

All the students are hereby informed that, the college level Best out of Waste event will be starting from 22 March 2022. All the interested students should enroll your name as an Individual or Group on or before 18<sup>th</sup> March 2022.

(Entry fees for Individual are Rs 10 and for Group /Team is Rs 20.)

Following Coordinators:-

SWARUPA (TE IT)

MITRI (SE ELE)

HIMANSHI (SE COMP)

#### Staff Coordinator

Prof. Jagruti More

Prof. Jayashree

Prof Jyoti Katela

#### Cultural Coordinator

Prof. Arbiya Shaikh

Prof. Rosy Bhoi



  
PRINCIPAL  
THEEM COLLEGE OF ENGINEERING  
At Village Betegaon, Boisar Chhitar Road  
Boisar (East) Tal. & Dist. Palghar - 401

# JASHN-E-THEEM 2022

## BEST OUT OF WASTE

22 MAR 2022



**Student Coordinators**

**Swarupa (TE IT)**

**Mitre (SE ELE)**

**Himanshi (SE Comp)**

**Staff Coordinators**

**Prof Jagruti More**

**Prof Jyoti katela**

**PRINCIPAL**

**THEEM COLLEGE OF ENGINEERING**  
At Village Betegaon, Borsar Chhatra Panchayat,  
Borsar (East) Tal. & Dist. Patancher





# H. J. THIM TRUST'S Theem College of Engineering, Boisar

Approved by AICTE (New Delhi) Government of Maharashtra & DTE  
Affiliated to University of Mumbai Est.: - 2009 - 2010

## Jashn-e-Theem 2022

### List of Winner of Individual Event

Category: Technical/ Sports/ Cultural (Tick any one)

Date: 22-03-22

Name of Event: BEST OF WASTE

Kindly award Certificate and Medals/ Trophies to the following students.

Name of Winner: (In Capital Letters Only)

IRAM ANSARI

Name of Winner

Branch: COMPUTER Year: 5E Mob. No. 9823352745  
(DEGREE)

Name of 1<sup>st</sup> Runner-Up: In Capital Letters Only)

HAMIRA SHAIKH

Name of 1st Runner-Up

Branch: INFORMATION Year: BE Mob. No. 8879543477  
TECHNOLOGY

Name of 2<sup>nd</sup> Runner-Up: In Capital Letters Only)

MANASI KIRAN UHARAT

Name of 2nd Runner-Up

Branch: COMPUTER Year: T-E Mob. No. 7399903247  
(DEGREE)



Head of Institute,  
Prof. Gawanoli Trust, Prof.

Head of Institute,  
Prof. Received by:

P.D. Head  
Prof. **PRINCIPAL**  
THEEM COLLEGE OF ENGINEERING  
At: Village Betegaon, Boisar Chikhar P.  
Boisar (East) Tal. & Dist. Palghar - 40



H. J. THIM TRUST'S  
**Theem College of Engineering, Boisar**

Approved by AICTE (New Delhi) Government of Maharashtra & DTE  
Affiliated to University of Mumbai Est.: - 2009 - 2010

Name of Winners: (In Capital Letters Only) (POSTER / DRAWING)

Sr.No	Name	Branch	Year	Mob. No.
1	Siddhi Cheulkar	Mech	BE	9725745495
2	Abhishek Mane	Mech	BE	8668045128
3				
4				
5				
6				
7				
8				
9				
10				
11				
12				
13				
14				

Event Incharge  
Prof.

Prof.

Head

Prof.

Received by

P.D Head

Prof.

PRINCIPAL

THEEM COLLEGE OF ENGINEERING  
At. Village Betegaon, Boisar Chikhar R.  
Boisar (East) Tal. & Dist. Palghar - 40



H. J. THIM TRUST'S  
**Theem College of Engineering, Boisar**  
Approved by AICTE (New Delhi) Government of Maharashtra & IETE  
Affiliated to University of Mumbai Est.: - 2009 - 2010

# Jashn-e-Theem 2022

## List of Winner of Group Event

Category: Technical/ Sports/ Cultural (Tick any one)

Date: 22/09/22

Name of Event: POASTER / DRAWING

Kindly award Certificate and Medals/ Trophies to the following students.

Name of Winners: (In Capital Letters Only)

1	S	I	D	D	M	Z	C	H	E	U	L	K	A	R	} group
2	A	B	H	I	S	H	E	K	M	A	N	E			
3															
4															
5															
6															
7															
8															
9															
10															
11															
12															
13															
14															

Event Incharge  
Prof.

Head  
Prof.

Received by  
Prof.

P.D Head  
Prof.



**PRINCIPAL**  
THEEM COLLEGE OF ENGINEERING  
At Village Betegaon, Boisar Chithar Road  
Boisar (East) Tal. & Dist. Palghar - 40





H. J. THIM TRUST'S

## THEEM COLLEGE OF ENGINEERING

### NOTICE

Date: 12/03/2022

All the students are hereby informed that, the college level Tattoo Painting event will be starting from 23 March 2022. All the interested students should enroll your name as an Individual or Group on or before 18<sup>rd</sup> March 2022.

(Entry fees for Individual are Rs 10 and for Group /Team is Rs 20.)

Following Coordinators:-

SWARUPA (TE IT)

MITRI (SE ELE)

HIMANSHI (SE COMP)

#### Staff Coordinator

Prof. Jagruti More

Prof. Jayashree

Prof Jyoti Katela

#### Cultural Coordinator

Prof. Arbiya Shaikh

Prof. Rosy Bhoi



PRINCIPAL  
THEEM COLLEGE OF ENGINEERING  
At, Village Betegaon, Borsar Chithar Road,  
Borsar (East) Tal. & Dist. Palohar - 481 124, Orissa

JASHN-E-THEEM 2022  
TATTOO PAINTING  
23 MAR 2022



**Student Coordinators**

**Swarupa (TE IT)**

**Mitre (SE ELE)**

**Himanshi (SE Comp)**

**Staff Coordinators**

**Prof Jagruti More**

**Prof Jyoti katela**

**PRINCIPAL**

**THEEM COLLEGE OF ENGINEERING**  
At. Village Betegaon, Borsar Chilhar Road,  
Borsar (East) Tal. & Dist. Palohar - M.P.







H. J. THIM TRUST'S  
**Theem College of Engineering, Boisar**

Approved by AICTE (New Delhi) Government of Maharashtra & DTE  
Affiliated to University of Mumbai Est.: - 2009 - 2010

# Jashn-e-Theem 2022

## List of Winner of Individual Event

Category: Technical/ Sports/ Cultural (Tick any one)

Date: 23-03-22

Name of Event: SALAD DECORATION.

Kindly award Certificate and Medals/ Trophies to the following students.

Name of Winner: (In Capital Letters Only)

SANIYA SHAIKH  
Name of Winner

Branch: INFORMATION Year: T.E. Mob. No. 7875374749  
TECHNOLOGY  
(DEGREE)

Name of 1<sup>st</sup> Runner-Up: In Capital Letters Only)

AASIYA KAZI  
Name of 1st Runner-Up

Branch: CIVIL DEGREE Year: B.E. Mob. No. 9029520687

Name of 2<sup>nd</sup> Runner-Up: In Capital Letters Only)

NAMIRA SHAIKH  
Name of 2nd Runner-Up

Branch: INFORMATION Year: T.E. Mob. No. 8879543477  
TECHNOLOGY  
(DEGREE)

Event Incharge

Prof. \_\_\_\_\_ Head

Received by:  
Prof. \_\_\_\_\_

P.D Head  
Prof. \_\_\_\_\_

PRINCIPAL

THEEM COLLEGE OF ENGINEERING  
At Village Betegaon, Boisar Chithar R.  
Boisar (East) Tal. & Dist. Palahar - 40





H. J. THIM TRUST'S

## THEEM COLLEGE OF ENGINEERING

### NOTICE

Date: 15/03/2022

All the students are hereby informed that, the college level Solo/Duet/Group/Dance and Drama (Boys and Girls) events will be starting from 24<sup>th</sup> March 2022. All the interested students should enroll your name as an Individual or Group on or before 21 March 2022.

(Entry fees for Individual are Rs 20 and for Group /Team is Rs 50.)

Following Coordinators:-

SHRISHA (TE COMP)

TEJAL (SE MECH)

SHEBAZ (TE IT)

MOHIT (TE ELE)

#### Staff Coordinator

Prof. Rosy Bhoi

Prof. Jayashree

Prof. Snehal Patil

#### Cultural Coordinator

Prof. Arbiya Shaikh

Prof. Rosy Bhoi



PRINCIPAL

THEEM COLLEGE OF ENGINEERING  
At. Village Betegaon, Boisar Chikhar Road  
Boisar (East) Tal. & Dist. Palohar - 401 202

# JASHN-E-THEEM 2022

Solo/Duet/Group/Dance and Drama

24 MAR 2022



## Student Coordinators

Shrisha (TE Comp)

Shebaz (TE IT)

Tejal (SE Mech)

Mohit (TE ELE)

## Staff Coordinators

Prof Rosy Bhoi

Prof Jayashree

A stylized signature in blue ink, likely belonging to Prof Snehal Patil.

Prof Snehal Patil

PRINCIPAL

THEEM COLLEGE OF ENGINEERING

At Village Betegaon, Borsar Chikher Road

Borsar (East) Tal. & Dist. Palehar - 47



inrl  
TAK?



# H. J. THIM TRUST'S Theem College of Engineering, Boisar

Approved by AICTE (New Delhi) Government of Maharashtra & DTE  
Affiliated to University of Mumbai Est.: - 2009 - 2010

## Jashn-e-Theem 2022

### List of Winner of Individual Event

Category: Technical/ Sports/ Cultural (Tick any one)

Date: 24/03/2022

Name of Event: Solo Dance

Kindly award Certificate and Medals/ Trophies to the following students.

Name of Winner: (In Capital Letters Only)

S H R I S H A S H E T T Y  
Name of Winner

Branch: EXTC Year: T.E Mob. No. 9518794502

Name of 1<sup>st</sup> Runner-Up: In Capital Letters Only

S A K S H I S I N G H  
Name of 1st Runner-Up

Branch: I.T. Year: B.E Mob. No. 7507978218

Name of 2<sup>nd</sup> Runner-Up: In Capital Letters Only

A I S H W A R Y A G O L A T K A R  
Name of 2nd Runner-Up

Branch: comps Year: S.E Mob. No. 9975946579



Head  
Prof. Arbija Shantik

Received by:  
Prof. PRINCIPAL

P.D Head  
Prof.

THEEM COLLEGE OF ENGINEERING  
Village Betegaon, Boisar Chithar Road  
Boisar (East) Tal. & Dist. Palghar.



H. J. THIM TRUST'S  
**Theem College of Engineering, Boisar**

Approved by AICTE (New Delhi) Government of Maharashtra & DTE  
Affiliated to University of Mumbai Est.: - 2009 - 2010

Name of Winners: (In Capital Letters Only) ( DANCE )

Sr.No	Name	Branch	Year	Mob. No.
1	SHRISHA SHETTY	EXTC	T.E	9518994502
2	TEJAL PATIL	Comp	T.E	
3	MOHIT MER	Mech	B.E	
4	MANAS MANKAR	Mech	B.E	
5				
6				
7				
8				
9				
10				
11				
12				
13				
14				

*Sneha*  
Event Incharge  
Prof. Sneha P.



*Srinivas*  
Head

Received by,  
Prof.

*[Signature]*  
P.D Head  
Prof.

**PRINCIPAL**  
THEEM COLLEGE OF ENGINEERING  
At. Village Betegaon, Boisar Chilar Road  
Boisar (East) Tal. & Dist. Palghar - 401 204







H. J. THIM TRUST'S  
**Theem College of Engineering, Boisar**

Approved by AICTE (New Delhi) Government of Maharashtra & DTE  
Affiliated to University of Mumbai Est.: - 2009 - 2010

**DANCE**

Name of 1<sup>st</sup> Runner-Up: (In Capital Letters Only)

Sr.No	Name	Branch	Year	Mob. No.
1	ANIKET MORE	MECH	T.E	
2	MANASVI DOIPHODE	EXTC	T.E	
3	TEJAL PATIL	Comp	T.E	
4	MOHIT MER	MECH	B.E	
5				
6				
7				
8				
9				
10				
11				
12				
13				
14				



Patil Prof. Head  
Received by  
Prof.

PD Head  
Prof. **PRINCIPAL**

**THEEM COLLEGE OF ENGINEERING**  
At. Village Betegaon, Boisar Chithar Road  
Boisar (East) Tal. & Dist. Palghar - 40





H. J. THIM TRUST'S  
**Theem College of Engineering, Boisar**

Approved by AICTE (New Delhi) Government of Maharashtra & DTE  
Affiliated to University of Mumbai Est.: - 2009 - 2010

Name of 2<sup>nd</sup> Runner-Up: (In Capital Letters Only) **DANCE**

Sr.No	Name	Branch	Year	Mob. No.
1	ANIKET MORE	MECH	T.E	9082447082
2	MANASVI DOIPHODE	EXTC	TE	
3				
4				
5				
6				
7				
8				
9				
10				
11				
12				
13				
14				

  
Event Incharge  
Prof. Smehal



Head

Prof.

Received by:

PRINCIPAL

THEEM COLLEGE OF ENGINEERING  
At. Village Betegaon, Boisar Chikhar Road  
Boisar (East) Tal. & Dist. Palghar - 401 301







# H. J. THIM TRUST'S Theem College of Engineering, Boisar

Approved by AICTE (New Delhi) Government of Maharashtra & DTE  
Affiliated to University of Mumbai Est.: - 2009 - 2010

## Jashn-e-Theem 2022

### List of Winner of Group Event

Category: Technical/ Sports/ Cultural (Tick any one)

Date: 24/03/22

Name of Event: DRAMA

Kindly award Certificate and Medals/ Trophies to the following students.

Name of Winners: (In Capital Letters Only) FATHER & SON.

1	W	A	L	I	M	O	M	A	M	M	A	D	K	A	D	R	I				
2	S	H	A	I	K	H	M	O	I	Z	S	H	A	K	E	E	L				
3	S	H	E	B	A	Z	S	H	E	R	U	S	H	A	I	K	H				
4	A	N	A	F	F	A	I	Y	A	Z	K	H	A	N							
5	H	A	Y	Y	A	N	M	E	H	B	O	O	B	V	O	R	A				
6	T	A	N	M	A	Y	P	R	A	K	A	S	H	M	A	R	A	D			
7	K	A	I	F	F	I	R	O	Z	E	S	A	Y	Y	D						
8	R	A	N	Q	A	R	J	R	E	H	A	N									
9																					
10																					
11																					
12																					
13																					
14																					

Gawandi  
Dean Incharge  
Prof. Gawandi  
Team

Head  
Prof. Anbigar  
Shaukh

Received by:  
Prof.

Prof.

**PRINCIPAL**  
THEEM COLLEGE OF ENGINEERING  
At. Village Betegaon, Boisar Chithar Road  
Boisar (East) Tal. & Dist. Palohar - 401 301



H. J. THIM TRUST'S

# Theem College of Engineering, Boisar

Approved by AICTE (New Delhi) Government of Maharashtra & DTE  
Affiliated to University of Mumbai Est.: - 2009 - 2010

Name of Winners: (In Capital Letters Only) **DRAMA / FATHER & SON**

Sr.No	Name	Branch	Year	Mob. No.
1	WALI MOHAMMAD KADRI	COMP	F.E	
2	SHAIKH MDIZ SHAIKHL	COMP	F.E	
3	SHEBAZ SHERU SHAIKH	COMP	F.E	
4	ANAF FAIYAZ KHAN	AJ/ML	F.E	
5	HAYYAN MEMBOOB VORA	COMP	F.E	
6	TANMAY PRARASH HARAD	ELE	F.E	
7	KAIF FIROZE SAYYD	COMP	F.E	
8				
9				
10				
11				
12				
13				
14				

Gawandi  
Event Incharge

Gawandi Iram

Prof. Arbiya Shaikh  
Head

Received by:  
Prof.

Prof. Head

PRINCIPAL

THEEM COLLEGE OF ENGINEERING  
At Village Betegaon, Boisar Chithar Road  
Boisar (East) Tal. & Dist. Palghar - 401 301







H. J. THIM TRUST'S

# Theem College of Engineering, Boisar

Approved by AICTE (New Delhi) Government of Maharashtra & DTE  
Affiliated to University of Mumbai Est.: - 2009 - 2010

## Jashn-e-Theem 2022

### List of Winner of Group Event

Category: Technical/ Sports/ Cultural (Tick any one)

Date: 24/03/22

Name of Event: DRAMA (SHARARTI BALMA)

Kindly award Certificate and Medals/ Trophies to the following students.

Name of 1<sup>st</sup> Runner-Up: (In Capital Letters Only)

1	K	A	L	Y	A	N	I	Q	A	N	E	S	H	J	M	A				
2	A	N	K	I	T	A	S	U	R	E	N	D	E	R	C	H	A	V	A	N
3	M	O	H	D	A	R	F	A	A	S	H	A	D	S	M	A	I	K	H	
4	S	A	F	A	S	A	L	I	M	S	A	Y	Y	E	D					
5	M	O	M	I	N	I	B	R	A	H	I	M	P	A	R	V	E	Z		
6	M	O	H	D	S	H	A	M	I	M	M	A	N	I	H	A	R			
7																				
8																				
9																				
10																				
11																				
12																				
13																				
14																				



Incharge

Prof. \_\_\_\_\_ Head

Received by:  
Prof. \_\_\_\_\_

Prof. \_\_\_\_\_ P.D Head

PRINCIPAL

THEEM COLLEGE OF ENGINEERING  
At Village Betegaon, Boisar Chithar Road,  
Boisar (East) Tal. & Dist. Palghar - 426



# THEEM COLLEGE OF ENGINEERING, BOISAR

H. J. THIM TRUST'S

Approved by AICTE (New Delhi) Government of Maharashtra & DTE  
Affiliated to University of Mumbai Est.: - 2009 - 2010

Name of 1<sup>st</sup> Runner-Up: (In Capital Letters Only) **DRAMA (SHARARTI BAICHA)**

Sr.No	Name	Branch	Year	Mob. No.
1	KALYANI ANANESH JHA	COMPS	F.E	
2	ANKITA SURENDER CHAVAN	COMPS	F.E	
3	MOHD. ARFA ASHAD SHAIKH	COMPS	F.E	
4	SABA SALIM SAYYED	COMPS	F.E	
5	MOMIN IBRAHIM PARVEZ	ELECTRICAL	S.E	
6	SHAMIM . R. MANIHAR	MELT	S.E	
7				
8				
9				
10				
11				
12				
13				
14				

Event Incharge  
Prof. Gawandi  
Joram



Prof. *Arbiya Shaikh* Head

Received by:  
Prof.

Prof. *[Signature]* P.D Head  
PRINCIPAL

THEEM COLLEGE OF ENGINEERING  
At. Village Betegaon, Boisar Chithar Road  
Boisar (East) Tal. & Dist. Palghar - 401 301



# H. J. THEM TRUST'S Theem College of Engineering, Boisar

Approved by AICTE (New Delhi) Government of Maharashtra & DTE  
Affiliated to University of Mumbai Est. - 2002 - 2010

Name of 2<sup>nd</sup> Runner-Up: (In Capital Letters Only) **DRAMA (MOMMA SON)**

Sr.No	Name	Branch	Year	Mob. No.
1	SHIVANI CHADMEKAR	CIVIL	T.E	Diploma
2	RIKAMA AHMEN HUSAN	CIVIL	F.E	
3				
4				
5				
6				
7				
8				
9				
10				
11				
12				
13				
14				

*Parvathi*  
Incharge  
Prof. *Parvathi Thim*

*Arbaya*  
Head  
Prof  
Received by

*[Signature]*  
Principal  
THEEM COLLEGE OF ENGINEERING  
At. Village Betegaon, Boisar Chiltar Rd.  
Boisar (East) Tal. & Dist. Palohar - 478









H. J. THIM TRUST'S  
**Theem College of Engineering, Boisar**

Approved by AICTE (New Delhi) Government of Maharashtra & DTE  
Affiliated to University of Mumbai Est.: - 2009 - 2010

# Jashn-e-Theem 2022

## List of Winner of Group Event

Category: Technical/ Sports/ Cultural (Tick any one)

Date:

Name of Event: Double Badminton (Girls)

Kindly award Certificate and Medals/ Trophies to the following students.

Name of <sup>Winner</sup> 2<sup>nd</sup> ~~Runner-Up~~: (In Capital Letters Only)

1	S	H	R	I	S	H	A	S	H	E	T	T	Y	(T	E	-	E	X	T	C)			
2	M	A	N	A	S	V	E	E	D	O	I	P	H	O	D	E	(T	E	-	E	X	T	C)
3																							
4																							
5																							
6																							
7																							
9																							
10																							
11																							
12																							
13																							
14																							



Prof. Head

Received by:  
Prof.

P.D. Head  
Principal  
THEEM COLLEGE OF ENGINEERING  
At. Village Betegaon, Boisar Chikhar Road  
Boisar (East) Tal. & Dist. Palghar - 401 301

H. J. Thim Trust's

# THEEM COLLEGE OF ENGINEERING

(Approved By AICTE (New Delhi), Government of Maharashtra & DTE, Affiliated To University Of Mumbai & MSBTE, Esld. 2009)



## Certificate of Merit

*Awarded to*

Mr./ Miss SOFIYA SHAIKH

Course INFORMATION TECHNOLOGY Year B.E

Participate TRADITIONAL DAY of **JASHN-E-THEEM**

and being adjudged WINNER in the year 2021-22

25-03-22

Date

Sofiya  
Co-ordinator

[Signature]  
Principal



[Signature]

PRINCIPAL  
THEEM COLLEGE OF ENGINEERING  
At Village Betegaon, Boisar Chitthar Road  
Boisar (East) Tal. & Dist. Palohar - 401 201





H. J. Thim Trust's

# THEEM COLLEGE OF ENGINEERING

(Approved By AICTE (New Delhi), Government of Maharashtra & DTE, Affiliated To University Of Mumbai & MSBTE, Estd. 2009)

## Certificate of Merit

*Awarded to*

Mr./Miss SALONI SUDHAKAR TANDEL

Course INFORMATION TECHNOLOGY Year B.E

Participate HANDWRITING COMPETITION (ENG) of JASHN-E-THEEM  
and being adjudged 2<sup>nd</sup> RONNER UP in the year 2021-22

25-03-22  
Date



[Signature]  
Co-ordinator

[Signature]  
Principal





H. J. Thim Trust's

# THEEM COLLEGE OF ENGINEERING

(Approved By AICTE (New Delhi), Government of Maharashtra & DTE, Affiliated To University Of Mumbai & MSBTE, Esd. 2009)

## Certificate of Merit

*Awarded to*

Mr./Miss WALID MOHAMMAD KADRI

Course COMPUTER Year FE

Participate PUBG (Team) of **JASHN-E-THEEM**

and being adjudged 1<sup>st</sup> RUNNER UP in the year 2022

25/03/2022

Date

Co-ordinator



Principal





H. J. Theem Trust's

# THEEM COLLEGE OF ENGINEERING

(Approved By AICTE (New Delhi), Government of Maharashtra & DTU, Affiliated To University Of Mumbai & MSBTE, Estd. 2009)

## Certificate of Merit

*Awarded to*

Mr./ Miss WALI MOHAMMAD KADRI

Course COMPUTER ENGINEERING Year F.E

Participate DRAMA of **JASHN-E-THEEM**

and being adjudged WINNER in the year 2021-22

25-03-2022

Date

Co-ordinator



Principal





H. J. THIM TRUST'S  
**THEEM COLLEGE OF ENGINEERING**

Approved by AICTE (New Delhi), Government of Maharashtra & DTE, Affiliated to University of Mumbai & MSBTE, Estd. 2009  
A NAAC Accredited Institute | Institute Code: EN3222

## Certificate

*This certificate is awarded to*

Mr./Ms. ADITYA JAYENDRA GUPTA of S.E. INFORMATION TECH.

*for Co-ordinating / Participating / Securing* 2nd PLACE *in the event of*  
BADMINTON DOUBLES *at* JASHN-E-THEEM *on* 25/03/2022

Event Co-ordinator



Principal

Village Betegaon, Boisar Chilhar Road, Boisar (E), Tal. & Dist. Palghar - 401 501. | Office: 7769916109 | Admission: 7506830077



H. J. THIM TRUST'S  
**THEEM COLLEGE OF ENGINEERING**

Approved by AICTE (New Delhi), Government of Maharashtra & DTE, Affiliated to University of Mumbai & MSBTE, Estd. 2009  
A NAAC Accredited Institute | Institute Code: EN3222

## Certificate

This certificate is awarded to

Mr/Ms. RUTUSA JADHAV

of IT (S.E)

for Co-ordinating / Participating / Securing FIRST PLACE in the event of  
THROW BALL (GIRLS) at **JASHN-E-THEEM** on 25.03.2022



Event Co-ordinator

Principal

Village Betegaon, Boisar Chilhar Road, Boisar (E), Tal. & Dist. Palghar - 401 501. | Office: 7769916109 | Admission: 7506830077



H. J. Thim Trust's

# THEEM COLLEGE OF ENGINEERING

(Approved By AKTE (New Delhi), Government of Maharashtra & DTE, Affiliated To University Of Mumbai & MSBTE, Edd. 2009)

## Certificate of Merit

*Awarded to*

Mr./ Miss SHUBH KHANDHAR

Course I.T Year T.E

Participate FOOTBALL of **JASHN-E-THEEM**

and being adjudged RUNNER-UP in the year 2022

**PRINCIPAL**

THEEM COLLEGE OF ENGINEERING  
At Village Betegaon, Boisar Chillar Road,  
Boisar (East) Tal. & Dist. Palohar.

25/03/2022

Date

Coordinator







H. J. THIM TRUST'S  
**THEEM COLLEGE OF ENGINEERING**

Approved by AICTE (New Delhi), Government of Maharashtra & DTE, Affiliated to University of Mumbai & MSBTE, Estd. 2009  
A NAAC Accredited Institute | Institute Code: EN3222

# Certificate

This certificate is awarded to

Mr./Ms. SHUBHAM DUBEY

of T.E. CIVIL

for ~~Co-ordinating~~ / ~~Participating~~ / ~~Securing~~ 1st PLACE in the event of

WAR

at **JASHN-E-THEEM** on 25/03/2022

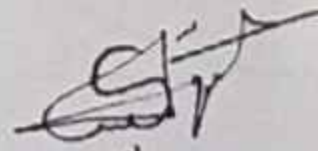

  
Event Co-ordinator

  
Principal



H. J. Thim Trust's

# THEEM COLLEGE OF ENGINEERING

(Approved By AICTE (New Delhi), Government of Maharashtra & DTE, Affiliated To University Of Mumbai & MSBTE, Estd. 2009)

## Certificate of Merit

*Awarded to*

Mr./ Miss SHUBHAM k. DUBEY

Course CIVIL Year T.E

Participate CRICKET ( BOYS ) of **JASHN-E-THEEM**

and being adjudged WINNER in the year 2022

25/03/2022  
Date



  
Co-ordinator



PRINCIPAL  
THEEM COLLEGE OF ENGINEERING  
At. Village Betegaon, Boisar Chitthar Road  
Boisar (East) Tal. & Dist. Palghar - 401 301





H. J. Thim Trust's

# THEEM COLLEGE OF ENGINEERING

(Approved By AICTE (New Delhi), Government of Maharashtra & DTE, Affiliated To University Of Mumbai & MSBTE, E#id. 2009)

## Certificate of Merit

*Awarded to*

Mr./ Miss SHAZEB RAZI

Course CIVIL Year T. E.

Participate CRICKET ( BOYS ) of **JASHN-E-THEEM**

and being adjudged WINNER in the year 2022

25/03/2022

Date



Co-ordinator

PRINCIPAL

THEEM COLLEGE OF ENGINEERING  
At. Village Betegauri, Tal. Palghar, Dist. Palghar - 401301  
Boisar (East) Tal. & Dist. Palghar - 401301





# H. J. THIM TRUST'S THEEM COLLEGE OF ENGINEERING

Approved by AICTE (New Delhi), Government of Maharashtra & DTE, Affiliated to University of Mumbai & MSBTE, Estd. 2009

A NAAC Accredited Institute | Institute Code: EN3222

## Certificate

This certificate is awarded to

Mr./Ms. ARCHIS RANJIT SAVE of S.E INFORMATION TECH.

for ~~Co-ordinating~~ / ~~Participating~~ / ~~Securing~~ 2<sup>nd</sup> PLACE in the event of  
BADMINTON DOUBLES at **JASHN-E-THEEM** on 25/03/2022

Event Co-ordinator



Principal

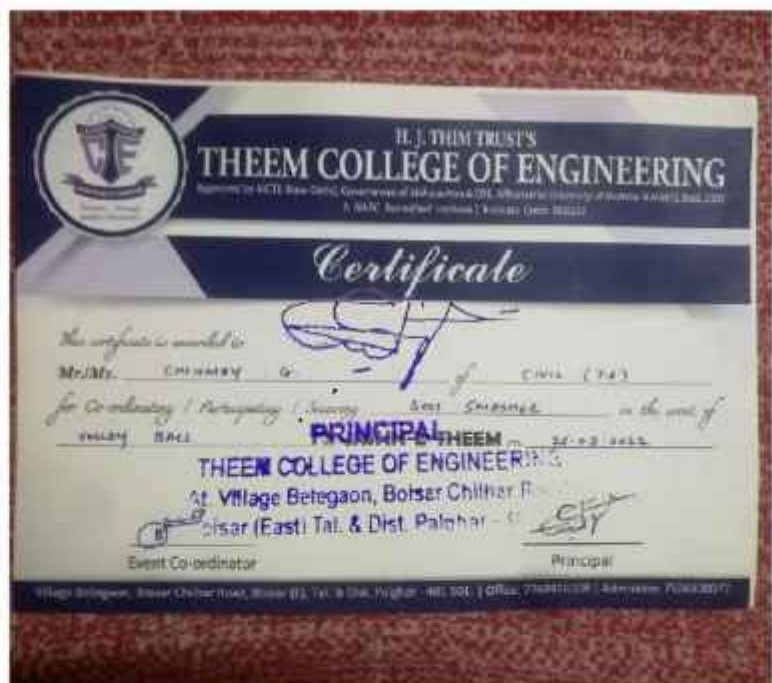





# H. J. THIM TRUST'S THEEM COLLEGE OF ENGINEERING

Approved by AICTE (New Delhi), Government of Maharashtra & DTE, Affiliated to University of Mumbai & MSBTE, Estd. 2009  
A NAAC Accredited Institute | Institute Code: EN3222

## Certificate

This certificate is awarded to

Mr./Ms. SOFIYA SHEIKH of IT (B.E)

for Co-ordinating / Participating / Securing FIRST PLACE in the event of  
THROW BALL (GIRLS) at **JASHN-E-THEEM** on 25.03.2022

Event Co-ordinator



Principal

Village Betegaon, Boisar Chillhar Road, Boisar (E), Tal. & Dist. Palghar - 401 501. | Office: 7769916109 | Admission: 7506830077





H. J. Thim Trust's

# THEEM COLLEGE OF ENGINEERING

(Approved By AICTE (New Delhi), Government of Maharashtra & DTE, Affiliated To University Of Mumbai & MSBTE, Estd. 2009)

## Certificate of Merit

*Awarded to*

Mr./Miss                     SOFIYA SHAIKH                    

Course                     IT                     Year                     

Participate           TUG OF WAR           (GIRLS)           of JASHN-E-THEEM            
and being adjudged           RUNNER UP           in the year           2022          



*[Handwritten signature]*

**PRINCIPAL**  
THEEM COLLEGE OF ENGINEERING  
At. Village-Betegaon, Palisar, Chitthar Road,  
Palsar (East) Tal. & Dist. Palnhar - 40  
*Principal*

          25/03/2022            
Date

*[Handwritten signature]*  
Co-ordinator



H. J. Thim Trust's

# THEEM COLLEGE OF ENGINEERING

(Approved By AICTE (New Delhi), Government of Maharashtra & DTE, Affiliated To University Of Mumbai & MSBTE, Estd. 2009)

## Certificate of Merit

*Awarded to*

Mr./ Miss PRATIK KHUTHIA

Course COMPUTER Year 5E

Participate PROGRAMMING CHALLENGE of **JASHN-E-THEEM**

and being adjudged BONSAR RUNNER UP in the year 2022



25/03/2022

Date

Co-ordinator

PRINCIPAL

THEEM COLLEGE OF ENGINEERING

At Village Betegaon, Bonsar Chiltar Road

Bonsar (East) Tal. & Dist. Palghar - Maharashtra

Principal





H. J. Thim Trust's

# THEEM COLLEGE OF ENGINEERING

(Approved By AICTE (New Delhi), Government of Maharashtra & DTE, Affiliated To University Of Mumbai & MSBTE, Estd. 2009)

## Certificate of Merit

*Awarded to*

Mr./ Miss PRATIK KHUTHIA

Course COMPUTER Year 5E

Participate PROGRAMMING CHALLENGE of **JASHN-E-THEEM**

and being adjudged 1st RUNNER UP in the year 2022



25/03/2022

Date

Co-ordinator

Principal





H. J. Thim Trust's

# THEEM COLLEGE OF ENGINEERING

(Approved By AICTE (New Delhi), Government of Maharashtra & DTE, Affiliated To University Of Mumbai & MSBTE, Esd. 2009)

## Certificate of Merit

*Awarded to*

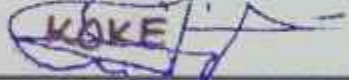
Mr./Miss MOHAMMAD ALIRAZA MUPHID 

Course COMPUTER ENGINEERING Year SE  

Participate PROGRAMMING QUIZ **PRINCIPAL**  
**THEEM COLLEGE OF ENGINEERING**  
At Village Beregaon, Borsar Chittar P.  
Borsar (East) Tal. & Dist. Palghar

and being adjudged RUNNER UP in the year 2022

25/03/2022  
Date

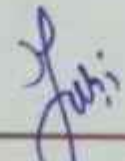
  
Co-ordinator

  
Principal



H. J. Thim Trust's

# THEEM COLLEGE OF ENGINEERING

(Approved By AICTE (New Delhi), Government of Maharashtra & DTE, Affiliated To University Of Mumbai & MSBTE, Estd. 2009)

## Certificate of Merit

*Awarded to*

Mr./ Miss SURAJ RAMASARE YADAV

Course IT Year TE

Participate TECHNICAL POSTER PRESENTATION OF JASHN-E-THEEM

and being adjudged 1<sup>st</sup> RUNNER UP in the year 2022

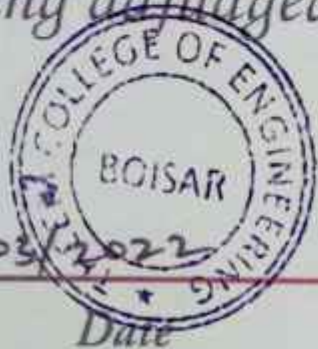

25/03/2022

Date

Co-ordinator

THEEM COLLEGE OF ENGINEERING  
At. Village Betegaon, Boisar, Chithar Road,  
Boisar (East) Tal. & Dist. Palohar - 401 301

Principal





H. J. Thim Trust's

# THEEM COLLEGE OF ENGINEERING

(Approved By AICTE (New Delhi), Government of Maharashtra & DTE, Affiliated To University Of Mumbai & MSBTE, Estd. 2009)

## Certificate of Merit

*Awarded to*

Mr./ Miss BHAUMIK PAGDHARE

Course COMPUTER Year SE

Participate PROGRAMMING CHALLENGE of **JASHN-E-THEEM**

and being adjudged 2<sup>nd</sup> RUNNER UP in the year 2022

25/03/2022

Date

Co-ordinator



Principal





H. J. THIM TRUST'S  
**THEEM COLLEGE OF ENGINEERING**

Approved by AICTE (New Delhi), Government of Maharashtra & DTE, Affiliated to University of Mumbai & MSBTE, Estd. 2009  
A NAAC Accredited Institute | Institute Code: EN3222

## Certificate

*This certificate is awarded to*

Mr./Ms. KUNAL SANTOSH RAUT of T.E MECHANICAL

for Co-ordinating / Participating / Securing 3<sup>rd</sup> PLACE in the event of

BADMINTON SINGLE (BOYS) at **JASHN-E-THEEM** on 25/03/2022

Event Co-ordinator



Principal



# H. J. THIM TRUST'S THEEM COLLEGE OF ENGINEERING

Approved by AICTE (New Delhi), Government of Maharashtra & DTE, Affiliated to University of Mumbai & MSBTE, Estd. 2009  
A NAAC Accredited Institute

## INSTITUTE LEVEL ENTREPRENEURSHIP COMPETITION

### Certificate of Excellence

Awarded to, Mr./Ms. Das Jiten Nagendra  
of Mechanical Engineering for securing 2nd Prize  
in **Challenge-I, Idea Presentation - Start-up Business Proposal**  
on 3D Technology organised by Department of  
**Mechanical Engineering & Theem Entrepreneurship & Start-up Cell**  
in association with IQAC, on 9<sup>th</sup> October, 2021.



  
Mentor-E Start-up Cell  
Prof. M. A. Gulbarga

  
Principal  
Dr. Shah Aqueel Ahmed

  
Director  
Dr. K. Rana



Village Betegaon, Boisar Chilhar Road, Boisar (E), Tal. & Dist. Palghar - 401 501. | [www.theemcoe.org](http://www.theemcoe.org)



H. J. THIM TRUST'S  
**THEEM COLLEGE OF ENGINEERING**

Approved by AICTE (New Delhi), Government of Maharashtra & DTE, Affiliated to University of Mumbai & MSBTE, Estd. 2009  
A NAAC Accredited Institute



INSTITUTION'S  
INNOVATION  
COUNCIL  
(Ministry of HRD Initiatives)

## Certificate of Excellence

This is to certify that **Mr./Ms. Tejal Lahange**  
is adjudged as **II** winner in **Poster Presentation** organized by  
**Department of Civil Engineering & NSS Team** on **15<sup>th</sup> September 2022**.

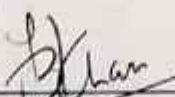

  
Co-ordinator  
Ms. Shaikh Arbiya

  
HOD  
Mr. Faiz Mohd. Khan

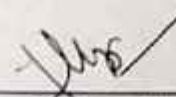
  
Principal  
Dr. Riyazuddin Siddiqui

  
Director  
Dr. N. K. Rana





H. J. THIM TRUST'S  
**THEEM COLLEGE OF ENGINEERING**

Approved by AICTE (New Delhi), Government of Maharashtra & DTE, Affiliated to University of Mumbai & MSBTE, Estd. 2009  
A NAAC Accredited Institute | Institute Code: EN3222

# Certificate

*This certificate is awarded to*

**Mr./Ms.** KUNAL. S. RAUT of T.E. MECH

for Co-ordinating / Participating / Securing SECOND PLACE in the event of  
VOLLEY BALL at **JASHN-E-THEEM** on 25.03.2022

Event Co-ordinator



Principal



H. J. Thim Trust's

# THEEM COLLEGE OF ENGINEERING

(Approved By AICTE (New Delhi), Government of Maharashtra & DTE, Affiliated To University Of Mumbai & MSBTE, Edid. 2009)

## Certificate of Merit

*Awarded to*

Mr./ Miss MONIKA BHOI

Course CIVIL Year         

Participate TUG OF WAR of **JASHN-E-THEEM**  
and being adjudged WINNER in the year 2022



25/03/2022  
Date

[Signature]  
Co-ordinator

[Signature]  
Principal





# H. J. THIM TRUST'S THEEM COLLEGE OF ENGINEERING

Approved by AICTE (New Delhi), Government of Maharashtra & DTE, Affiliated to University of Mumbai & MSBTE, Estd. 2009  
A NAAC Accredited Institute | Institute Code: EN3222

## Certificate

*This certificate is awarded to*

Mr./Ms. GANESH SHETE of CIVIL (TY)

for Co-ordinating / Participating / Securing FIRST PLACE in the event of  
VOLLEY BALL at **JASHN-E-THEEM** on 25.03.2022

Event Co-ordinator



Principal





H. J. Thim Trust's

# THEEM COLLEGE OF ENGINEERING

(Approved By AICTE (New Delhi), Government of Maharashtra & DTE, Affiliated To University Of Mumbai & MSBTE, Estd. 2009)

## Certificate of Merit

*Awarded to*

Mr./ Miss TEJAL LAHANGE

Course CIVIL Year \_\_\_\_\_

Participate TUG OF WAR (GIRLS) of **JASHN-E-THEEM**

and being adjudged WINNER in the year 2022

25/03/2022

Date

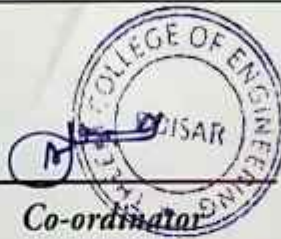

Co-ordinator

Principal



H. J. THIM TRUST'S  
**THEEM COLLEGE OF ENGINEERING**

Approved by AICTE (New Delhi), Government of Maharashtra & DTE, Affiliated to University of Mumbai & MSBTE, Estd. 2009  
A NAAC Accredited Institute | Institute Code: EN3222

## Certificate

*This certificate is awarded to*

Mr./Ms. ZOHA SHAIKH

of SE COMPUTER

for Co-ordinating / Participating / Securing 1<sup>st</sup> RANK in the event of  
RELAY (GIRLS TEAM) at **JASHN-E-THEEM** on 24/03/2022

Event Co-ordinator



Principal

Village Betegaon, Boisar Chilhar Road, Boisar (E), Tal. & Dist. Palghar - 401 501. | Office: 7769916109 | Admission: 7506830077



H. J. THIM TRUST'S  
**THEEM COLLEGE OF ENGINEERING**

Approved by AICTE (New Delhi), Government of Maharashtra & DTE, Affiliated to University of Mumbai & MSBTE, Estd. 2009  
A NAAC Accredited Institute | Institute Code: EN3222

# Certificate

*This certificate is awarded to*

Mr./Ms. ZOHA SHAIKH of S.E - COMPS

for *Co-ordinating / Participating / Securing* 1st PLACE in the event of  
CRICKET (GIRLS) at **JASHN-E-THEEM** on 25/03/2022

\_\_\_\_\_  
Event Co-ordinator





\_\_\_\_\_  
Principal

Village Betegaon, Boisar Chilhar Road, Boisar (E), Tal. & Dist. Palghar - 401 501. | Office: 7769916109 | Admission: 7506830077





# H. J. THIM TRUST'S THEEM COLLEGE OF ENGINEERING

Approved by AICTE (New Delhi), Government of Maharashtra & DTE, Affiliated to University of Mumbai & MSBTE, Estd. 2009  
A NAAC Accredited Institute | Institute Code: EN3222

## Certificate

This certificate is awarded to

Mr./Ms. ZOHA SHAIKH of COMPS

for Co-ordinating / Participating / Securing SECOND PLACE in the event of  
THROW BALL (GIRLS) at **JASHN-E-THEEM** on 25.03.2022

Event Co-ordinator



Principal

Village Betegaon, Boisar Chilhar Road, Boisar (E), Tal. & Dist. Palghar - 401 501. | Office: 7769916109 | Admission: 7506830077



H. J. THIM TRUST'S  
**THEEM COLLEGE OF ENGINEERING**

Approved by AICTE (New Delhi), Government of Maharashtra & DTE, Affiliated to University of Mumbai & MSBTE, Estd. 2009  
A NAAC Accredited Institute | Institute Code: EN3222

## Certificate

This certificate is awarded to

Mr./Ms. Shaikh Zoha of Computer (S.E)

for Co-ordinating / Participating / Securing 3<sup>rd</sup> Rank in the event of  
Running 100M (Girls) at **JASHN-E-THEEM** on 24/03/2022

Event Co-ordinator



Principal

Village Betegaon, Boisar Chilhar Road, Boisar (E), Tal. & Dist. Palghar - 401 501. | Office: 7769916109 | Admission: 7800183007



H. J. Thim Trust's

# THEEM COLLEGE OF ENGINEERING

(Approved By AICTE (New Delhi), Government of Maharashtra & DTE, Affiliated To University Of Mumbai & MSBTE, Estd. 2009)

## Certificate of Merit

*Awarded to*

Mr./ Miss SOFIYA ALTAJ SHAIKH

Course INFORMATION TECHNOLOGY Year B. E.

Participate HANDWRITING COMPETITION (ENG) of **JASHN-E-THEEM**

and being adjudged WINNER in the year 2021-22

25-03-22

Date



[Signature]  
Co-ordinator

[Signature]

Principal





H. J. Thim Trust's  
**THEEM COLLEGE OF ENGINEERING**  
(Approved by AICTE / New Delhi, Commission of Maharashtra & STS, Affiliated To University Of Mumbai & MAHTE, Estd. 2001)

## Certificate of Merit

*Awarded to*

Mr./ Miss ANIKET MORE  
Course MECHANICAL ENGINEERING Year T.E  
Participate GROUP DANCE of **JASHN-E-THEEM**  
and being adjudged 2<sup>nd</sup> RUNNER UP in the year 2021-22

25-03-22  
Date



[Signature]  
Co-ordinator

[Signature]  
Principal



H. J. Thim Trust's

# THEEM COLLEGE OF ENGINEERING

(Approved By AICTE (New Delhi), Government of Maharashtra & DTE, Affiliated To University Of Mumbai & MSHTE, Estd. 2005)

## Certificate of Merit

*Awarded to*

Mr./ Miss           ANIKET MORE          

Course           MECHANICAL ENGINEERING           Year           T.E          

Participate           GROUP DANCE           of **JASHN-E-THEEM**

and being adjudged           1<sup>st</sup> RUNNER UP           in the year           2021-22          

          25-03-22          

Date

          *S. Singh*            
Co-ordinator



          *[Signature]*          

Principal



**PRINCIPAL**  
THEEM COLLEGE OF ENGINEERING  
At Village Betegaon, Boisar Chithar Road,  
Boisar (East) Tal. & Dist. Palghar - 401 304.





POCO  
SHOT ON POCO M2

24/03/2022 ATHLETICS-JAVELIN



  
PRINCIPAL  
THEEM COLLEGE OF ENGINEERING  
St. Village Botegaon, Boisar Chikher Road,  
Boisar (East) Tal. & Dist. Palanpur - 385001



  
**PRINCIPAL**  
THEEM COLLEGE OF ENGINEERING  
St. Village Batogaon, Boisar Chitwan Road,  
Boisar (East) Tal. & Dist. Patkote - 421 101





22/03/2022 BEST OUT OF WASTE



PRINCIPAL  
THE COLLEGE OF ENGINEERING  
BOSAR, SANGLI  
WILSON ROAD, SANGLI  
MAHARASHTRA





23/03/2022 SALAD DECORATION

*Signature*  
MEMORIAL  
THIRUVARUR COLLEGE OF ENGINEERING  
At Village Deivanai, Dattar Chikkar Road  
Thiruv. (East) Tal. & Dist. Pudukottai - 605 001



**VOLLEYBALL**  
22/03/2022



**PRINCIPAL**  
THEEM COLLEGE OF ENGINEERING  
At Village Botegaon, Boisar Chithar Road,  
Boisar (East) Tal. & Dist. Palohar, Ahmednagar Dist.

A.Y  
2020-21





# H. J. THIM TRUST'S THEEM COLLEGE OF ENGINEERING

Approved by AICTE (New Delhi), Government of Maharashtra & DTE, Affiliated to University of Mumbai & MSBTE, Estd. 2009  
NAAC Accredited with B+ Grade

Village Betegaon, Boisar Chilhhar Road, Boisar (E), Tal. & Dist.: Palghar - 401 501.

Tel.: (02525) 284 909 • Fax : (02525) 284 927 • Email : info@theemcoe.org • Website : www.theemcoe.org

## Year 3 A.Y.2020-21

Date of event/activity (DD-MM-YYYY)	Name of the event/activity	Name of the organising institution	Name of the student participated
<b>SPORTS</b>			
13/3/2021 to 14/03/2021	Tennis Cricket Tournament	TCOE	Pratik yadav,Hardik Sunil bari,Ghodake Manav vasant,Dhoni yash mahesh,Yadav deepak,Bhavesh Akre,Mrinal Patil,Hrutik mali,Patil Atharva Mahesh,Mit Kishor Pawar,Divyanshu Kishor Raut,Yadav Ankit Shishupal,Pratap Bipic,Swapnil Wavare,Mitesh Sharma,Patil prathamesh Sanjay



  
PRINCIPAL  
THEEM COLLEGE OF ENGINEERING  
At Village Betegaon, Boisar Chilhhar Road,  
Boisar (East) Tal. & Dist. Palghar - 401 501

## 5.3.3 Average number of sports and cultural activities/competitions organized at the institution level in 2020-21 (Additional Details)

SR. No.	NAME OF SCHOOL	NAME OF PT/SPORTS TEACHER	CONTACT NO. OF PT/SPORTS TEACHER	NAME OF PRINCIPAL/HEAD MASTER	CONTACT NO. OF PRINCIPAL/HEAD MASTER	NAME & CONTACT NO. OF STUDENT
01	Tarapurvidyamandir & Junior college	Prushottam Paisul e	9272368117	Joan Rosario		Pratik Yadav 9890233870
02	YASH RAJ ENGLISH HIGH SCHOOL & JR. COLLEGE, DHANANI NAGAR, BOISAR (W)	FAYYAZUDDIN SHAIKH	8087199328	GAUSIYA SHAIKH	9130701658	SAURABH TIWARI - 7219855876
03	DYAN BHARTI'S BSES JR. COLLEGE OF SCIENCE, VADKAN, DAHANU ROAD.	-----	-----	RAVINDRA GHAGHASKAR SIR	7743995515	HARDIK SUNIL BARI - 8010139206
04	Lt Saa V ADHIKARI & JR CLG, Lalonde, Palghar	SHRI DEEPAK RAWAT	9850051063	SHRI SUNIL NAIK	NA	GHODAKE MANAV VASANT- 7798116355
05	Smt Mitrabai A C Jr Ctg (Sevashram)	Mishra Sir	9561659059	SHRI RAVINDRA PIMPLE	8855934182	Dhodi Yash Mahesh- 8767781400
06	Sri Raghunir Madhyamik Vidyalay, Boisar	Vinod Gupta	7208699567	Virendra Kumar Yadav	9657672935	Yadav Deepak - 9096967267
07	MK Junior College Chinchani	HARISH WADVI	9422666072	SARVOFE	NA	BHAGESH AKRE
08	Janta High School, Navapur	Samidha Thakur	9823713325	Sudhakar Thakur	9860259751	Mrunal Patil - 7756804506
09	LATE SAU VIDYA VINOD ADHIKARI VIDYALAYA & JR. COLLEGE LALONDE	DEEPAK PATIL	9850051063	NAIK PATIK	NA	HRUTIK MALI 8000684864
10	Twinkle Star English High School, Palghar	Mayur Pawar	8308700055	Kedar Mahajan	9158135172	Patil Atharva Mahesh- 9284044110
11	Dr. S.D Vartak Vidyalaya Boisar	Vaishali Bwapnis h	8270881714	Darel Thomas Dimole	NA	Mit Keshav Pawar - 7249655201
12	Vanskruti Jr. College, Lalonde, Palghar	Danish Pathan	8234410114	Rushikesh Holi	9252121672	Dnyaneshwar shri Ravi - 9172759068
13	Shri Raghunir Jr. College of Sci & Commerce,	Guddu Sir	9870871248	Virendra Kumar	9657672035	Yadav Arvind Shriharaj - 7219055872



	Boisar					
14	Shaskiyamatsyawya wasanyshala ,Satpati	chaudhri	8446865682	Shinde	9119436776	prathamkpin c 9588637067
15	Ashram ShalaBetegaon	Deepak Suresh	7875601005	Rajesh Mhatre	9284006962	Swapnil Wav are 7875601005
16	Dandekar B palghar	KiranThorat	7767067567	Kiransagar	8600260790	Mitlesh Sharma 9370557663
17	Dandekar Jr. College (RH Save Arts C.J.) A palghar	KiranThorat	7767067567	Kiransagar	8600260790	PatilPratham esh Sanjay 9307480793



Principal

Dr. Shah Aqueel Ahmad

**PRINCIPAL**  
THEEM COLLEGE OF ENGINEERING  
Boisar (East) Tal. & Dist. Palghar -401 501.



**PRINCIPAL**  
THEEM COLLEGE OF ENGINEERING  
4, Village Betegaon, Boisar, District Palghar - 401 501.  
Boisar (East) Tal. & Dist. Palghar - 401 501.





# H. J. THIM TRUST'S THEEM COLLEGE OF ENGINEERING

Approved by AICTE (New Delhi), Government of Maharashtra & DTE, Affiliated to University of Mumbai & MSBTE, Estd. 2009  
A NAAC Accredited Institute

Institute Code  
**EN3222**

Present's

## TENNIS CRICKET TOURNAMENT

from 26<sup>th</sup> to 27<sup>th</sup> November, 2021

**1<sup>st</sup>**  
**Prize**

**₹ 7,777**  
**TROPHY**



**2<sup>nd</sup>**  
**Prize**

**₹ 4,444**  
**TROPHY**

PRINCIPAL  
THEEM COLLEGE OF ENGINEERING  
St. Village Betgaon, Bolisar Chikkar, Bolisar (East) Tal. & Dist. Palnhar

**GROUP A School**



**Jr. College GROUP B**

**CASH & TROPHY FOR BEST BATSMAN | BEST BOWLER | MAN OF THE TOURNAMENT**

Co-ordinators:  
Mr. Priyasan Thakur : 7709355703  
Mr. Harshal Ahire : 8275124797  
Mr. Sumit Mhatre : 9730408448

**FREE ENTRY**

**SCAN FOR  
REGISTRATION**



A.Y

2019-20



# H. J. THIM TRUST'S THEEM COLLEGE OF ENGINEERING

Approved by AICTE (New Delhi), Government of Maharashtra & DTE, Affiliated to University of Mumbai & MSBTE, Estd. 2009  
NAAC Accredited with B+ Grade

Village Betagaon, Boisar Chillhar Road, Boisar (E), Tal. & Dist.: Palghar - 401 501.

Tel.: (02525) 284 909 • Fax : (02525) 284 927 • Email : info@theemcoe.org • Website : www.theemcoe.org

## Year 2 A.Y.2019-20

Date of event/activity (DD-MM-YYYY)	Name of the event/activity	Name of the organising institution	Name of the student participated
<b>SPORTS (Jashn -E- Theem)</b>			
6/1/2020	Running 100m (Boys)	TCOE	bhoir Bhavin Rohidas,khan Mo Shahid,Chavan Ajinkya Sushil
6/1/2020	Running 100m(Girls)	TCOE	Chaudhary Dhanashree vasant,Jadhav Komal vasudev
6/1/2020	Running 200m(boys)	TCOE	Nirban Ruman usman,Chauhan Pritam Dinesh
6/1/2020	Long Jump(Boys)	TCOE	Kadam Advait Vivek,Pal Rahul Rajesh
6/1/2020	Long Jump(Girls)	TCOE	Mhatre Tejashree Kailas,Singh Ankita Anilkumar
6/1/2020	Discuss Throw(Boys)	TCOE	Patel Mahendra Omprakash,Bari Daywat Rakesh,kadam Mayur Subhash
6/1/2020	Discuss Throw(Girls)	TCOE	Patil Samiksha Jitendra,Patil Simran N.,Yadav Soni Triochan
8/1/2020	shotput (Boys)	TCOE	Patel Pritesh Ganeshbhai,Phadatare Girish Hanumant,Srirag Sreekumar
8/1/2020	Shotput(Girls )	TCOE	Patil Shruti Shivaji,Jadyar Ketaki suryakant,Patil Shivani manoj,
8/1/2020	Javelin(Girls)	TCOE	Mallah Julee Laxman,Jadyar Ketaki Suryakant,siddiqui saaima Neyaz
8/1/2020	Javelin(Boys)	TCOE	Jaiswal Ravi Kalluprasad,Gaykwad Nayan Dipak,Singh Shashank
7/1/2020	Football	TCOE	Ansari Afsana Mohd Farook,Bhairagi Abhishek ,Barde Gaurav,Bhosale sarvesh,Chamute Pratik shivaji
7/1/2020	Throwball (Girls)	TCOE	Gilani Anisha Salim,Jha Rakhi Nagendra,Bhoi Durga ,pimple saloni, Gaikwad prajyoti
<b>Cultral (Jashn -E- Theem)</b>			
17/1/2020	stand up comedy	TCOE	Dalvi Shubham Yashwant,Bharamade Hitesh Jagannath,Kanade Riddesh Dinesh
14/1/2020	Retro days(Boys)	TCOE	Bhafalekar Shreyas Prashant,Ahire Prathamesh Ashok,Bhosale Parag
14/1/2020	Retro days(Girls )	TCOE	Patil Gauri Pramod,Gupta Nehal Anandkumar,Dive Aditi Dattatrey
15/1/2020	Traditional Day(Boys)	TCOE	Ahmad Ansar Jalil,Bhoir Hitesh vinayak ,Gupta kundan Rambilas
15/1/2020	Traditional Day(Girls)	TCOE	Rashivate Rasika Manohar,Patil Riddhi Rajan,sonawane pranali pratap
13/1/2020	Cook without fire	TCOE	mallah julee laxman,Patil Shivani manoj,Pawar jyoti mahadu
14/1/2020	Mehandi competition	TCOE	Parmar Mitali Babulal,Pawar shweta Balu,Maurya Neha
15/1/2020	Face Makover	TCOE	Patil Unnati Deepak,Kazi Aasiya Nisarahmad,Pimple saloni deepak
15/1/2020	poster painting competition	TCOE	Patil Dipesh Madhukar,Mallick MD.Mahsin Ali Rafik,Maknogiya Salman Yunus

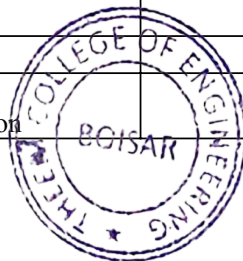

THEEM COLLEGE OF ENGINEERING  
At Village Betagaon, Boisar Chillhar Road,  
Boisar (East) Tal. & Dist. Palghar - 401 501



16/1/2020	Intra singing competition	TCOE	Khan Rizwan Islamkhan,bhoye Ashutosh Dilip,khan movie moiz
13/1/2020	Mismatch Day(Girls)	TCOE	Chauhan nidhi udaiprakash,maurya neha,Patil Shreya kalpesh
11/1/2020	Bollywood day(Boys)	TCOE	jha manish pravin,Bhagat jay anand,kalia Abdulaziz sarfraz
11/1/2020	Bollywood day(Girls)	TCOE	Dubey Sakshi Rajmani,Gaikwad Prajyoti pratapsinh,khachane vaibhavi
16/1/2020	solo Dance(Intra)	TCOE	Chauhan Pritam Dinesh,Mallick Md.Mahsin Ali Rafik,Lambe Kashinath Tanaji
14/1/20	Rangoli	TCOE	Gawade Shreya Janardhan,Koli prajakta ashok,Patil jaiee kiran



  
**PRINCIPAL**  
 THEEM COLLEGE OF ENGINEERING  
 At. Village Betegaon, Boisar Chithar Road  
 Boisar (East) Tal. & Dist. Palghar - 401 501



H. J. THIM TRUST'S

# THEEM COLLEGE OF ENGINEERING

*Presents*

# JASHN-E-THEEM 2020

## ATHLON

16 - 18 Jan

*Cricket*  
*Football*  
*Volleyball*

## PROMETHEAN

16 - 18 Jan

*Robo-race*  
*Robo-war*  
*Junior Scientist*

**Contact:**

Gaurav Kini : 7030187801  
Meet Mistry : 9867434226  
Utkarsh Gharat : 8788340588

**Contact:**

Ashutosh Mishra : 9834605569  
Victor Samanta : 9503973095  
Nimesh More : 9867318699



H. J. THIM TRUST'S  
**THEEM COLLEGE OF ENGINEERING**  
Approved By AICTE (New Delhi), Government of Maharashtra & DTE, Affiliated To University of Mumbai & MSBTE. Estd. 2009  
NAAC Accredited with B+ Grade

**Jashn-E-Theem 2020**

**Cultural Event\_Decennial Celebration\_2020**

Events Name	Staff Coordinator	Student Coordinator	Student Coordinator Mobile	Final Event Schedule		
				Date	Time	Venue
1.Group Attire Day	Prof. Rosy Bhoi(9766160629), Prof. Maya Patil(9970407910), Prof. Jayashree Sali(8698705911)			1/7/2020	2:30 PM	Main Entrance Gate - Main Stage
2.Saree/Formal/Rose Day	Prof. Ansar Shaikh(9405734267), Mrs. Surekha Attarde(7385103900)			1/8/2020	2:30 PM	
3.Bollywood / Chocolate Day	Prof. Rosy Bhoi(9766160629), Prof. Maya Patil(9970407910), Prof. Jayashree Sali(8698705911)			1/9/2020	2:30 PM	
4.Traditional Day	Prof. Ansar Shaikh(9405734267), Mrs. Surekha Attarde(7385103900)			1/10/2020	2:30 PM	



**PRINCIPAL**  
THEEM COLLEGE OF ENGINEERING  
At Village Betegaon, Borsar Chikhar Road,  
Borsar (East) Tal. & Dist. Palghar-40



# JASHN - E - THEEM 2020

(DATE: 16/01/2020 TO 18/01/2020)

OVER ALL COORDINATOR MR AZIZ-UR-REHMAN SIR

Sr.No.	Event	Chief Co-ordina ors	Members
01	Prize Distribution	<p style="text-align: center;"><i>aziz ur rehman sir</i></p> <p>Prof. Tilottama Deore &amp; Prof. Rahatullah Khan</p>	<p>Prof. Roshan Wani            Prof. Srikrishna Sonavane            Prof. Iqbal Mansoori, <del>Prof. Obaid Ansari</del>            Prof. Ganesh Rodge            Prof. Basavraj            Mr. Sayyed Kazim Ali            Prof. S. V. Ali            Prof. Abdul Naved            Prof. N.G. Hiremath            Prof. Majid Shaikh            Prof. Nitin Galawade            Prof. Mushtaque Ahmed            Prof. Aqsa Shaikh            Ms. Sayali Patil (Comp)            Prof. Sneha Sankhe            Prof. Surraiya Shaikh  <del>Prof. Sneha Sankhe</del>            Prof. Tasneem Azam            Ms. Tanvi Raut            Shahid Ahmed</p>
02	 Sports	<p style="text-align: center;"><i>Prashant Rathod</i></p> <p>Prof. Prashant Rathod  <i>Mr. Khalid Akh</i></p>	<p>Prof. Syed Tanzeem, Prof. Awani            Sankhe, Prof. Vinod Dhande,            Prof. Rajesh Patil, Prof. Sarita Tiwari,            Prof. Tejal Raut, Prof. Krunal  <del>Pimple, Prof. Krunal</del>            Kumari, Prof. Emily Ghosh,            Prof. Khalid Pinjari, Ms. Hemlata            Jangale, Prof. Arsalan Khan, Prof. Iqbal</p>

*Aziz*

			<p>Mansoori, Dr. A. Jyothikumari,  <del>Prof. Ashraf Siddique, Prof. Prof. Harshal</del>  <del>Abire, Prof. K.N. Attarde, Prof. Umar</del>  <del>Jamadar, Ms. Oniza</del>  <del>Shaikh, Mr. Roshan Vade, Ms. Sayali</del>  <del>Pimple, Mr. Ravindra Dawane,</del>  <del>Prof. Ganesh Rodge,</del>  <del>Prof. Nitin Sall, Ms. Sayali</del>  <del>Mahajan, Prof. Faiz Shaikh, Prof. Rosy</del>  <del>Bhoi, Prof. Abid Ansari, Prof. Rajat</del>  <del>Singh, Prof. Ruchi Rahi, Prof. Azar</del>  <del>Nabi, Mr. Priyasan</del>  <del>Thakur, Ms. Vaishali</del>  <del>Patil, Prof. Nirajsingh Yeotikar,</del>  <del>Prof. Ayaz Bagwan, Mr. Kazim</del>  <del>Ali, Mr. Sumit Mhatre.</del></p>
03	Cultural	<p><del>Arshad Hussain</del>  <del>Prof. Shakir Hussain</del>  <del>Anwar Hussain</del>  <del>And</del>  <del>Prof. Geetha Yadur</del>  <del>Rosy Bhoi</del></p>	<p><del>Prof. Tejal Raut, Prof. Ayni Sankhe,</del>  <del>Prof. Ishan Wash, Prof. Rosy Bhoi,</del>  <del>Prof. Maya Patil, Prof. Sheeb Khan,</del>  <del>Prof. Zulfiquar, Prof. Snehal</del>  <del>Pawde, Prof. Priyanka Patil, Prof.</del>  <del>Jayashree Sali, Prof. Nitin Sall,</del>  <del>Ms. Surekha Attarde, Mr. Abusaeed.</del></p>
04	Technical	<p>Prof. Rajesh Patil  <del>Ahmed Hussain</del></p>	<p>Prof. Khemchandra Attarde,  <del>Prof. Nirajsingh Yeotikar, Prof. Furqan</del>  <del>Hassan, Hemlata Jangale, Surekha</del>  <del>Attarde, Moin Ansari, Sneha</del>  <del>Sankhe, Amjad ali, Khalil Pinjari, Abu</del>  <del>saeed, Ahmad Shaikh, Manoj</del>  <del>Gwada, Nitin Sall, Harshad</del>  <del>Ranadive, Surayya Shaikh, Tasnoom</del>  <del>Azam, Sneha Sankhe, , Arsalan</del>  <del>khan, Shaikh afjal, Ansari Abid, Sheeb</del>  <del>Khan, Naeem Jilani, Abid Ansari,</del>  <del>Mushtaque Ahmed, Tojes Thakur,</del>  <del>Waseem Khan, Nitin Sall, Tasnoom</del>  <del>Azam, Nisar shah, Firoj Pathan, Oniza</del>  <del>Shaikh.</del></p>

*Uyaz*



  
 PRINCIPAL  
 THEEM COLLEGE OF ENGINEERING  
 At Village Belgaoon, Bolker Chitkar Road,  
 Boisar (East) Tal. & Dist. Palghar - 401 301

*[Handwritten signature]*

05	Magazine	Prof. Balasubramani	Dr. Amritanshu Kumar, Mr. Rashikh Shaikh, Azhar Nabi, Prof. Srikrishna Sonawane.
06	Finance	Prof. Raees Ahmad	Prof. Khalil Binjari, Ashraf Shah, Rajesh Patil, Niraj Singh Yeotkar, Vinod Dhande, Ruchi Rahi, Shaikh Ahmad.
07	Discipline	Prof. Saleem Pasha Chaudhary	Sayyad Layak B., Zulfiquar, Wasim Khan, Harshal Patil, Khemchandra Attarde, Gulbarga sir, Ayaz Bagwan, Prashant Rathod, Khalil Binjari, Anshu Tiwari, Sneha Sankhe, Awni Sankhe, Umar Jamadar, Mr. Roshan Wade, Mr. Ravindra Dawane, Mr. Sandesh Patil, Mr. Rupesh Sankhe, Ms. Sheetal Patil, Ms. Hemlata Jangale.

*Fringsham  
Rohit Khan  
E-mail  
mishra*



(DR. N. K. RANA)

Director

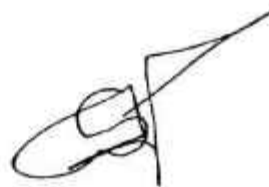
(DR. SHAH AQUEEL AHMED)

Principal



PRINCIPAL  
THEEM COLLEGE OF ENGINEERING  
At Village Bilegaon, Baisar Chitthar Road  
Baisar (East) Tal. & Dist. Patkhar



Name Of Event		Co-ordinator Name					
<b>OutDoor Games</b>							
1	Cricket (Girls)	Ruchi Rahi	Sayali Mahajan	Sayali Pimple			
2	Cricket <i>Main - V</i>	Mohd. Raes	Harshal Ahire	Ansar Shaikh	Priyasan Thakur	Krunal Pimple	Vinod Dhande
3	Cricket (BOX)	Ahmed Shaikh	Abid Ansari	Sumit Mhatre			
4	Football <i>Main - V</i>	Syed Tanzeem	Khalil Pinjari	Faiz Shaikh	Raes Ahmed	Vivek Anand	Kazim
5	ValleyBall <i>Main - V</i>	IQBAL MANSURI	K N Attarde	Imran Khan		Manoj Gowda	Amol Patil
6	ThrowBall (Girls)	Tasneem	Hemlata	Sayali Patil	Vaishali Patil	Sureka Attarde	
7	Kabbadi (Girls)	Rosy Bhoi	Hemlata jangale	Ruchi Rahi			
8	Kabaddi	Umar Jamadar	Balaji Dadas	Abid Sir			
9	Kho Kho (Girls)	Jyothi K.	Oniza Shaikh	Surekha Attarde			
10	Kho Kho	Krunal Pimple	Roshan Wade	Rupesh Sankhe			
11	Badminton	Jyothi Kumari	Mrunali Kokate	Rajat Siggh	Santosh Dubey		
12	Tug Of War	Tejas Thakur	Ravi Dhavne	Jitendra Chavan			
13	Blind Fold & Blind Hit Man	Khalil Pinjari	Abu. Syed	Mehraj Saifee			
<b>Athletics Event</b>							
1	100M (Boys)+200M	Prof. Inayat Khan	Prof. Ganesh Rodge	Shubham Bhandari			
2	100M (Girls)	Hemata Jangale	Surekha Attarde	Ruchi Rahi	Oniza Shaikh		
3	Relay	Arsalan KHAN					
4	Javelin	Ansar Shaikh					
5	Disc Throw	IRFAN KHAN					
6	Short Put	IQBAL MANSURI					
<b>Indoor Games</b>							
22	Chess	Emily Ghosh	Wasim Sultan	Ganesh Sir			
23	Carrom	Promod Mourya	Nitin Sall				
24	Neon Cricket	Ashraf Siddiqui	Waseem Sultan	Azhar Nabi	Vivek Anand		



**PRINCIPAL**  
**THEEM COLLEGE OF ENGINEERING**  
 At. Village Betegaon, Boisar Chitihar Road,  
 Boisar (East) Tal. & Dist. Patnagarh (SI)



H.J. Thim Trust's

**THEEM COLLEGE OF ENGINEERING**

BoisarChilhar Road, Boisar (E), Tal.Palghar, Dist.Thane 401 501

Tel.: (02525) 284 909, Fax.: (02525) 284 927

Date: 26-11-2019

All the students are hereby informed that **JASHN – E – THEEM 2020** has been scheduled in second and third week of January (16 to 18 )

Those students who want to participate as an organizing committee member should enroll or submit their name with events (Culture, Sports, technical) to their concerned HODs.

(Dr.Shah Aqueel Ahmed)

Principal



(Dr.N.K.Rana)

Director

PRINCIPAL  
THEEM COLLEGE OF ENGINEERING  
Village Betagan, Boisar Chilhar Road  
Boisar (East) Tal. & Dist. Palghar



H. J. THIM TRUST'S

## THEEM COLLEGE OF ENGINEERING

### NOTICE

Date: 12/01/2020

All the students are hereby informed that, the college level stand up comedy event will be starting from 17 Jan 2020. All the interested students should enroll your name as an Individual or Group on or before 18<sup>rd</sup> Jan 2020.

(Entry fees for Individual are Rs 10 and for Group /Team is Rs 20.)

Following Coordinators:-

SHUBHAM (TE COMP)

HITESH (SE MECH)

RIDDESH (TE COMP)

#### Staff Coordinator

Prof. Snehal patil

Prof. Jayashree

Prof Jyoti Katela

#### Cultural Coordinator

Prof. Rosy Bhoi



PRINCIPAL

THEEM COLLEGE OF ENGINEERING

At, Village Boregaon, Bosisar Chitkar Rd-01

Bosisar (East) Tal. & Dist. Palohar - 471 001



# JASHN-E-THEEM 2020 STANDUP COMEDY

17 JAN 2020



**Student Coordinators**  
**SHUBHAM (TE COMP)**  
**RIDDESH (TE Comp)**

**HITESH (SE MECH)**

**Staff Coordinators**  
**Prof. SNEHAL PATIL**  
**Prof. Jayashree**



  
**PRINCIPAL**  
THEEM COLLEGE OF ENGINEERING  
St. Village Brotegaon, Boisar Chitambar  
Boisar (East) Tal. & Dist. Palghar



H. J. THIM TRUST'S

# Theem College of Engineering, Boisar

Approved by AICTE (New Delhi) Government of Maharashtra & DTE  
Affiliated to University of Mumbai Est.: - 2009 - 2010

## Jashn-e-Theem-2020

### List of Winner of Individual Event

Category: Technical/ Sports/ Cultural (Tick any one)

Date: 17/1/20

Name of Event: Stand Up Comedy

Name of Winner: (In Capital Letters Only)

Dalvi Shubham Yashwant

Theme (if any):

Branch: COMP

Year: BE

Mob. No.

Name of 1<sup>st</sup> Runner-Up: In Capital Letters Only)

Bharambe Hitesh Jagannath

Theme (if any):

Branch: COMP

Year: SE

Mob. No.

Name of 2<sup>nd</sup> Runner-Up: In Capital Letters Only)

Kanade Riddhesh Dinesh

Theme (if any):

Branch: EXTC

Year: TE

Mob. No:

Event coordinator	Event Head	Received by:	PD Head
Student: <u>        </u>	Staff: <u>        </u>	Staff: <u>        </u>	Prof. <u>        </u>

PRINCIPAL  
THEEM COLLEGE OF ENGINEERING  
St. Village Bhatgaon, Boisar Chikhar Road  
Boisar (East) Tal. & Dist. Palghar - 40





H. J. THIM TRUST'S

# Theem College of Engineering, Boisar

Approved by AICTE (New Delhi) Government of Maharashtra & DTE  
Affiliated to University of Mumbai Est.: - 2009 - 2010

## Jashn-e-Theem-2020

### List of Winner of Individual Event

Category: Technical/ Sports/ Cultural (Tick any one)

Date: 24/1/20

Name of Event: Retro Day(BOYS)

Name of Winner: (In Capital Letters Only)

Bhafalekar Shreyas Prashant

Theme (if any):

Branch: IT Year: BE Mob. No.

Name of 1<sup>st</sup> Runner-Up: In Capital Letters Only)

Ahire Prathamesh Ashok

Theme (if any):

Branch:AUTO Year:BE Mob. No.

Name of 2<sup>nd</sup> Runner-Up: In Capital Letters Only)

Bhosale Parag Anant

Theme (if any):

Branch: ELECTRICAL Year:BE Mob. No:

PRINCIPAL  
THEEM COLLEGE OF ENGINEERING  
42, Village Bhatgaon, Bomer Chitner Road,  
Boisar (East) Tal. & Dist. Palghar - 40

Event coordinator Student: <u>Kus</u>	Event Head Staff: <u>Prashant</u>	Received by: Staff: <u>Prashant</u>	PD Head Prof. <u>Prashant</u>
--	--------------------------------------	--	----------------------------------







H. J. THIM TRUST'S

## THEEM COLLEGE OF ENGINEERING

### NOTICE

Date: 03/03/2020

All the students are hereby informed that, the college level Cultural Days Celebration (Boys and Girls) events will be starting from 11<sup>th</sup> March 2020. All the interested students should enroll your name as an Individual or Group on or before 07 March 2020.

(Entry fees for Individual are Rs 10 and for Group /Team is Rs 40.)

Following Coordinators:-

NIDHI (TE IT)

NEHA(TE COMP)

JAY (SE MECH)

MANISH(SE ELE)

#### Staff Coordinator

Prof. Jayashree

Prof. Snehal Patil

Prof. Sonali K

#### Cultural Coordinator

Prof. Rosy Bhoi



PRINCIPAL

THEEM COLLEGE OF ENGINEERING  
At, Village Betegaon, Boisar Chithar Road,  
Boisar (East) Tal. & Dist. Palahar - 40

# JASHN-E-THEEM 2020

## CULTURAL DAYS CELEBRATION

### 11 MAR 2020



#### Student Coordinators

Nidhi (TE IT)

Jay (SE Mech)

Neha (TE Comp)

Manish (SE ELE)

#### Staff Coordinators

Prof Jayashree

Prof Sneha Patil

Prof Sonali K



PRINCIPAL

THEEM COLLEGE OF ENGINEERING  
Village: Bheegaon, Boisar, District: Palghar  
Jash Road, Tal: A. Dist: Palghar





H. J. THIM TRUST'S

# Theem College of Engineering, Boisar

Approved by AICTE (New Delhi) Government of Maharashtra & DTE  
Affiliated to University of Mumbai Est.: - 2009 - 2010

## Jashn-e-Theem-2020

### List of Winner of Individual Event

Category: Technical/ Sports/ Cultural (Tick any one)

Date: 14/1/20

Name of Event: Retro Day(GIRLS)

Name of Winner: (In Capital Letters Only)

Patil Gauri Pramod

Theme (if any):

Branch:COMP Year:BE Mob. No.

Name of 1<sup>st</sup> Runner-Up: In Capital Letters Only)

Gupta Nehal Anandkumar

Theme (if any):

Branch:CIVIL Year: BE Mob. No.

Name of 2<sup>nd</sup> Runner-Up: In Capital Letters Only)

Dive Aditi Dattatrey

Theme (if any):

Branch:EXTC Year: DSE Mob. No:

PRINCIPAL  
THEEM COLLEGE OF ENGINEERING  
At Village Belegaon, Boisar Chitthar B.  
Boisar (East) Tal. & Dist. Palghar.

Event coordinator Student: <u>Vijay</u>	Event Head Staff: <u>Sahil</u>	Received by: Staff: <u>Pray</u>	PD Head Prof. <u>Pray</u>
--	-----------------------------------	------------------------------------	------------------------------







H. J. THIM TRUST'S

# Theem College of Engineering, Boisar

Approved by AICTE (New Delhi) Government of Maharashtra & DTE  
Affiliated to University of Mumbai Est.: - 2009 - 2010

## Jashn-e-Theem-2020

### List of Winner of Individual Event

Category: Technical/ Sports/ Cultural (Tick any one)

Date: 15/7/20

Name of Event: Traditional Day(Boys)

Name of Winner: (In Capital Letters Only)

Ahmed Ansar Jalil

Theme (if any):

Branch: COMP

Year: TE

Mob. No.

Name of 1<sup>st</sup> Runner-Up: In Capital Letters Only)

Bhoir Hitesh Vinayak

Theme (if any):

Branch: COMP

Year: TE

Mob. No.

Name of 2<sup>nd</sup> Runner-Up: In Capital Letters Only)

Gupta Kundan Rambilas

Theme (if any):

Branch: EXTC

Year: TE

Mob. No:

PRINCIPAL  
THEEM COLLEGE OF ENGINEERING  
At Village Beteagan, Boisar, Tal. Boisar, Dist. Palghar - 401 301

Event coordinator	Event Head	Received by:	PD Head
Student: <u>Kis</u>	Staff: <u>Bodhan</u>	Staff: <u>PNJ</u>	Prof. <u>SPK</u>





H. J. THIM TRUST'S

# Theem College of Engineering, Boisar

Approved by AICTE (New Delhi) Government of Maharashtra & DTE  
Affiliated to University of Mumbai Est.: - 2009 - 2010

## Jashn-e-Theem-2020

### List of Winner of Individual Event

Category: Technical/ Sports/ Cultural (Tick any one)

Date: 18/1/20

Name of Event: Traditional Day(Girls)

Name of Winner: (In Capital Letters Only)

Rashivate Rasika Manohar

Theme (if any):

Branch: ELECTRICAL

Year: DSE

Mob. No.

Name of 1<sup>st</sup> Runner-Up: In Capital Letters Only)

Patil Riddhi Rajan

Theme (if any):

Branch: ELECTRICAL

Year: DSE

Mob. No.

Name of 2<sup>nd</sup> Runner-Up: In Capital Letters Only)

Sonawane Pranali Pratap

Theme (if any):

Branch: IT

Year: FE

Mob. No:

  
PRINCIPAL  
THEEM COLLEGE OF ENGINEERING  
at Village Bategaon, Boisar Chiher Road  
(near East Tal. & Dist. Palghar)

Event coordinator Student: <u>Kis</u>	Event Head Staff: <u>Pradha</u>	Received by: Staff: <u>Pradha</u>	PD Head Prof. <u>Pradha</u>
--	------------------------------------	--------------------------------------	--------------------------------





H. J. THIM TRUST'S

## THEEM COLLEGE OF ENGINEERING

### NOTICE

Date: 05/01/2020

All the students are hereby informed that, the college level Cook Without Fire (Boys and Girls) event will be starting from 13 Jan 2020. All the interested students should enroll your name as an Individual or Group on or before 10 Jan 2020.

(Entry fees for Individual are Rs 10 and for Group /Team is Rs 30.)

Following Coordinators:-

SHIVANI (SE ELE)

JYOTI (SE IT)

JULEE (SE COMP)

#### Staff Coordinator

Prof. Arbiya Shaikh

Prof. Jayashree

Prof Snehal Patil

#### Cultural Coordinator

Prof. Rosy Bhoi



  
PRINCIPAL  
THEEM COLLEGE OF ENGINEERING  
At, Village Baraman, Baraman Chikar (B.)  
Dist. (East) Tel. & Dist. Palghar - 407 501



# JASHN-E-THEEM 2020

## COOK WITHOUT FIRE

13 Jan 2020



**Student Coordinators**

**Shivani (SE ELE)**

**Julee (SE Comp)**

**Jyoti (SE IT)**

**Staff Coordinators**

**Prof Arbiya Shaik**

**Prof. Snehal Patil**



**PRINCIPAL**  
THEEM COLLEGE OF ENGINEERING  
Village Botegaon, Bobisar Chitradurga  
Tal. & Dist. Patanhalli

**Prof Jayashree**



H. J. THIM TRUST'S

# Theem College of Engineering, Boisar

Approved by AICTE (New Delhi) Government of Maharashtra & DTE  
Affiliated to University of Mumbai Est.: - 2009 - 2010

## Jashn-e-Theem-2020

### List of Winner of Individual Event

Category: Technical/ Sports/ Cultural (Tick any one)

Date: 13/11/20

Name of Event: Cook without Fire

Name of Winner: (In Capital Letters Only)

Mallah Julee Laxman

Theme (if any):

Branch: EXTC Year: TE Mob. No.

Name of 1<sup>st</sup> Runner-Up: In Capital Letters Only)

Patil Shivani Manoj

Theme (if any):

Branch: CIVIL Year: TE Mob. No.

Name of 2<sup>nd</sup> Runner-Up: In Capital Letters Only)

Pawar Jyoti Mahadu

Theme (if any):

Branch: COMP Year: TE Mob. No:

PRINCIPAL  
THEEM COLLEGE OF ENGINEERING  
St. Village Boregaon, Boisar City (Dist. Palghar)  
Palghar (East) Tal. & Dist. Palghar

Event coordinator	Event Head	Received by:	PD Head
Student: <u>KS</u>	Staff: <u>Bois</u>	Staff: <u>PM</u>	Prof: <u>SB</u>







H. J. THIM TRUST'S

## THEEM COLLEGE OF ENGINEERING

### NOTICE

Date: 06/01/2020

All the students are hereby informed that, the college level Mehandi event will be starting from 14 Jan 2020. All the interested students should enroll your name as an Individual or Group on or before 10 March 2020.

(Entry fees for Individual are Rs 10 and for Group /Team is Rs 20.)

Following Coordinators:-

MITALI (TE IT)                      NEHA (SE ELE)  
HIMANSHI (SE COMP)

#### Staff Coordinator

Prof. Jagruti More

Prof. Jayashree

Prof Jyoti Katela

#### Cultural Coordinator

Prof. Arbiya Shaikh

Prof. Rosy Bhoi



  
**PRINCIPAL**  
THEEM COLLEGE OF ENGINEERING  
At. Village Betgaon, Bosisar Chilhara Rd.  
Bosisar (East) Tal. & Dist. Palohar - 371 004





H. J. THIM TRUST'S

# Theem College of Engineering, Boisar

Approved by AICTE (New Delhi) Government of Maharashtra & DTE  
Affiliated to University of Mumbai Est.: - 2009 - 2010

## Jashn-e-Theem-2020

### List of Winner of Individual Event

Category: Technical/ Sports/ Cultural (Tick any one)

Date: 14/12/20

Name of Event: Mehendi Competition

Name of Winner: (In Capital Letters Only)

**Parmar Mitali Babulal**

Theme (if any):

**Branch: ELECTRICAL**

**Year: TE**

**Mob. No.**

Name of 1<sup>st</sup> Runner-Up: In Capital Letters Only)

**Pawar Shweta Balu**

Theme (if any):

**Branch: ELECTRICAL**

**Year: TE**

**Mob. No.**

Name of 2<sup>nd</sup> Runner-Up: In Capital Letters Only)

**Maurya Neha**

Theme (if any):

**Branch: MECH**

**Year: TE**

**Mob. No:**

PRINCIPAL  
THEEM COLLEGE OF ENGINEERING  
St. Village Bategaon, Boisar Taluka Tal.  
Boisar (East) Tal. & Dist. Palghar - 401 301

Event coordinator Student: <u>Kas</u>	Event Head Staff: <u>Isdrh</u>	Received by: Staff: <u>pmv</u>	PD Head Prof. <u>SPC</u>
--	-----------------------------------	-----------------------------------	-----------------------------





H. J. THIM TRUST'S

# Theem College of Engineering, Boisar

Approved by AICTE (New Delhi) Government of Maharashtra & DTE  
Affiliated to University of Mumbai Est.: - 2009 - 2010

## Jashn-e-Theem-2020

### List of Winner of Individual Event

Category: Technical/ Sports/ Cultural (Tick any one)

Date: 15/1/20

Name of Event: Face Makover

Name of Winner: (In Capital Letters Only)

Patil Unnati Deepak

Theme (if any):

Branch: EXTC

Year: BE

Mob. No.

Name of 1<sup>st</sup> Runner-Up: In Capital Letters Only)

Kazi Aasiya Nisarahmed

Theme (if any):

Branch: CIVIL

Year: DSE

Mob. No.

Name of 2<sup>nd</sup> Runner-Up: In Capital Letters Only)

Pimple Saloni Deepak

Theme (if any):

Branch: EXTC

Year: BE

Mob. No:

PRINCIPAL  
THEEM COLLEGE OF ENGINEERING  
At Village Britegaon, Boisar Taluka Boisar  
Dist. Palghar - 40

Event coordinator	Event Head	Received by:	PD Head
Student: <u>Kis</u>	Staff: <u>Joshi</u>	Staff: <u>pry</u>	Prof. <u>Jisc</u>





H. J. THIM TRUST'S

## THEEM COLLEGE OF ENGINEERING

### NOTICE

Date: 09/01/2020

All the students are hereby informed that, the college level Poster Painting (Boys and Girls) event will be starting from 15 Jan 2020. All the interested students should enroll your name as an Individual or Group on or before 12 Jan 2020.

(Entry fees for Individual are Rs 10 and for Group /Team is Rs 30.)

Following Coordinators:-

SWARUPA (TE IT)

MITRI (SE ELE)

HIMANSHI (SE COMP)

**Staff Coordinator**

Prof. Priyanka Patil

**Cultural Coordinator**

Prof. Rosy Bhoi



  
**PRINCIPAL**  
THEEM COLLEGE OF ENGINEERING  
At Village Betegaon, Bolisar Chitkar Road,  
Bolisar (East) Tal. & Dist. Palahar - 41



# JASHN-E-THEEM 2020

## POSTER PAINTING

15 Jan 2020



**Student Coordinators**

**Swarupa (TE IT)**

**Mitri (TE Comp)**

**Himanshi (SE Comp)**

**Staff Coordinators**

**Prof priyanka Patil**



**PRINCIPAL**  
THEEM COLLEGE OF ENGINEERING  
At Village Boragan, Borar Chitli, Boisar (East), Tal. & Dist. Palghar - 407 505



H. J. THIM TRUST'S

# Theem College of Engineering, Boisar

Approved by AICTE (New Delhi) Government of Maharashtra & DTE  
Affiliated to University of Mumbai Est.: - 2009 - 2010

## Jashn-e-Theem-2020

### List of Winner of Individual Event

Category: Technical/ Sports/ Cultural (Tick any one)

Date: 18/1/20

Name of Event: poster painting competition

Name of Winner: (In Capital Letters Only)

Patil Dipesh Madhukar

Theme (if any):

Branch: EXTC      Year: BE      Mob. No.

Name of 1<sup>st</sup> Runner-Up: In Capital Letters Only)

Mallie Md.Mahsin Ali Rafik

Theme (if any):

Branch: IT      Year: BE      Mob. No.

Name of 2<sup>nd</sup> Runner-Up: In Capital Letters Only)

Maknogiya Salman Yunus

Theme (if any):

Branch: MECH      Year: TE      Mob. No:

PRINCIPAL  
THEEM COLLEGE OF ENGINEERING  
At: Village Birtegaon, Bomsar-Chilmer Road,  
Boisar (East) Tal. & Dist. Patan.

Event coordinator	Event Head	Received by:	PD Head
Student: <u>KES</u>	Staff: <u>EDW</u>	Staff: <u>PMY</u>	Prof. <u>SKC</u>







H. J. THIM TRUST'S

## THEEM COLLEGE OF ENGINEERING

### NOTICE

Date: 10/01/2020

All the students are hereby informed that, the college level Intra singing competition event will be starting from 16 Jan 2020. All the interested students should enroll your name as an Individual or Group on or before 12<sup>rd</sup> Jan 2020.

(Entry fees for Individual are Rs 10 and for Group /Team is Rs 20.)

Following Coordinators:-

SHUBHAM (BE COMP)

HITESH (TE MECH)

RIDDESH (BE COMP)

#### Staff Coordinator

Prof. Snehal patil

Prof. Jayashree

Prof Jyoti Katela

#### Cultural Coordinator

Prof. Rosy Bhoi



PRINCIPAL  
THEEM COLLEGE OF ENGINEERING  
At Village Betegaon, Boisar Chhitar Road,  
Boisar (East) Tal. & Dist. Palohar - 395 001



# JASHN-E-THEEM 2020

## INTRA SINGING COMPETITION

16 Jan 2020



**Student Coordinators**  
**Shubham (BE Comp)**  
**Riddesh (BE Comp)**

**Hitesh (TE Mech)**

**Staff Coordinators**  
**Prof Snehal Patil**  
**Prof Jyoti katela**



  
**PRINCIPAL**  
THEEM COLLEGE OF ENGINEERING  
At Village Bilegaon, Bolser, Chikar, Tal. Bilegaon,  
Dist. Palghar - 407 505



H. J. THIM TRUST'S

# Theem College of Engineering, Boisar

Approved by AICTE (New Delhi) Government of Maharashtra & DTE  
Affiliated to University of Mumbai Est.: - 2009 - 2010

## Jashn-e-Theem-2020

### List of Winner of Individual Event

Category: Technical/ Sports/ Cultural (Tick any one)

Date: 16/11/20

Name of Event: Intra singing competition

Name of Winner: (In Capital Letters Only)

**Khan Rizwan Islamkhan**

Theme (if any):

Branch: IT

Year: FE

Mob. No.

Name of 1<sup>st</sup> Runner-Up: In Capital Letters Only)

**Bhoye Ashutosh Dilip**

Theme (if any):

Branch: MECH

Year: FE

Mob. No.

Name of 2<sup>nd</sup> Runner-Up: In Capital Letters Only)

**Khan Mosir Moiz**

Theme (if any):

Branch: COMP

Year: DSE

Mob. No:

PRINCIPAL  
THEEM COLLEGE OF ENGINEERING,  
N. Village Betejgaon, Boisar District Boisar  
Boisar (East) Tal. & Dist. Palghar

Event coordinator Student: <u>KA</u>	Event Head Staff: <u>Joshi</u>	Received by: Staff: <u>Pmy</u>	PD Head Prof. <u>Sire</u>
---	-----------------------------------	-----------------------------------	------------------------------



H. J. THIM TRUST'S

# Theem College of Engineering, Boisar

Approved by AICTE (New Delhi) Government of Maharashtra & DTE  
Affiliated to University of Mumbai Est.: - 2009 - 2010



## Jashn-e-Theem-2020

### List of Winner of Individual Event

Category: Technical/ Sports/ Cultural (Tick any one)

Date: 13/6/20

Name of Event: Mismatch Day(Girls)

Name of Winner: (In Capital Letters Only)

Chauhan Nidhi Udaiprakash

Theme (if any):

Branch: IT

Year: BE

Mob. No.

Name of 1<sup>st</sup> Runner-Up: In Capital Letters Only)

Maurya Neha

Theme (if any):

Branch: MECH Year: TE

Mob. No.

Name of 2<sup>nd</sup> Runner-Up: In Capital Letters Only)

Patil Shreya Kalpesh

Theme (if any):

Branch: IT

Year: BE

Mob. No:

PRINCIPAL  
THEEM COLLEGE OF ENGINEERING  
At Village Betgaon, Boisar Taluka, Dist. Palghar

Event coordinator	Event Head	Received by:	PD Head
Student: <u>Kin</u>	Staff: <u>Joshi</u>	Staff: <u>Pony</u>	Prof. <u>Joshi</u>







H. J. THIM TRUST'S

# Theem College of Engineering, Boisar

Approved by AICTE (New Delhi) Government of Maharashtra & DTE  
Affiliated to University of Mumbai Est.: - 2009 - 2010

## Jashn-e-Theem-2020

### List of Winner of Individual Event

Category: Technical/ Sports/ Cultural (Tick any one)

Date: 11/11/20

Name of Event: Bollywood day(Boys)

Name of Winner: (In Capital Letters Only)

**Jha Manish Pravin**

Theme (if any):

**Branch: COMP      Year: DSE      Mob. No.**

Name of 1<sup>st</sup> Runner-Up: In Capital Letters Only)

**Bhagat Jay Anand**

Theme (if any):

**Branch: ELECTRIAL      Year: FE      Mob. No.**

Name of 2<sup>nd</sup> Runner-Up: In Capital Letters Only)

**Kalia Abdulaziz Sarfraz**

Theme (if any):

**Branch: COMP      Year: DSE      Mob. No:**

PRINCIPAL  
THEEM COLLEGE OF ENGINEERING  
At: Village Betegaon, Boisar, Chikhal B-  
Dist: (East) Tal. & Dist. Palghar - 40

Event coordinator	Event Head	Received by:	PD Head
Student: <u>Kis</u>	Staff: <u>Bhad</u>	Staff: <u>any</u>	Prof. <u>SR</u>





H. J. THIM TRUST'S

# Theem College of Engineering, Boisar

Approved by AICTE (New Delhi) Government of Maharashtra & DTE  
Affiliated to University of Mumbai Est.: - 2009 - 2010

## Jashn-e-Theem-2020

### List of Winner of Individual Event

Category: Technical/ Sports/ Cultural (Tick any one)

Date: 4/1/20

Name of Event: Bollywood day(Girls)

Name of Winner: (In Capital Letters Only)

Dubey Sakshi Rajmani

Theme (if any):

Branch: IT

Year: BE

Mob. No.

Name of 1<sup>st</sup> Runner-Up: In Capital Letters Only)

Gaikwad Prajyoti Pratapsinh

Theme (if any):

Branch:COMP

Year: DSE

Mob. No.

Name of 2<sup>nd</sup> Runner-Up: In Capital Letters Only)

Khachane Vaibhavi Yuvraj

Theme (if any):

Branch:COMP

Year: DSE

Mob. No.

PRINCIPAL  
THEEM COLLEGE OF ENGINEERING  
At Village Beteagan, Boisar Chikhat Rd.  
Boisar (East) Tal. & Dist. Palanpur

Event coordinator Student: <u>kin</u>	Event Head Staff: <u>Ishita</u>	Received by: Staff: <u>pry</u>	PD Head Prof. <u>[Signature]</u>
--	------------------------------------	-----------------------------------	-------------------------------------





H. J. THIM TRUST'S

# Theem College of Engineering, Boisar

Approved by AICTE (New Delhi) Government of Maharashtra & DTE  
Affiliated to University of Mumbai Est.: - 2009 - 2010

## Jashn-e-Theem-2020

### List of Winner of Individual Event

Category: Technical/ Sports/ Cultural (Tick any one)

Date: 16/11/20

Name of Event: solo Dance (Intra)

Name of Winner: (In Capital Letters Only)

**Chauhan Pritam Dinesh**

Theme (if any):

**Branch: MECH**

**Year: FE**

**Mob. No.**

Name of 1<sup>st</sup> Runner-Up: In Capital Letters Only)

**Mallic Md.Mahsin Ali Rafik**

Theme (if any):

**Branch: IT**

**Year: BE**

**Mob. No.**

Name of 2<sup>nd</sup> Runner-Up: In Capital Letters Only)

**Lambe Kashinath Tanaji**

Theme (if any):

**Branch: IT**

**Year: BE**

**Mob. No:**

PRINCIPAL  
THEEM COLLEGE OF ENGINEERING  
At Village Botejason, Boisar, Chiplun Dist.  
Dist. (East) Tal. & Dist. Palghar - 40

Event coordinator	Event Head	Received by:	PD Head
Student: <u>Kis</u>	Staff: <u>Solar</u>	Staff: <u>pmj</u>	Prof. <u>Be</u>







H. J. THIM TRUST'S

## THEEM COLLEGE OF ENGINEERING

### NOTICE

Date: 09/01/2020

All the students are hereby informed that, the college level Rangoli event will be starting from 14 Jan 2020. All the interested students should enroll your name as an Individual or Group on or before 11 Jan 2020.

(Entry fees for Individual are Rs 10 and for Group /Team is Rs 20.)

Following Coordinators:-

PRAJAKTA (TE COMP)

SHREYA (SE ELE)

KIRAN (SE IT)

#### Staff Coordinator

Prof. Jagruti More

Prof. Jayashree

Prof Jyoti Katela

#### Cultural Coordinator

Prof. Rosy Bhoi



  
PRINCIPAL  
THEEM COLLEGE OF ENGINEERING  
At Village Betegaon, Boisar Chikhar Road,  
Boisar (East) Tal. & Dist. Palohar - AP - 522 201

# JASHN-E-THEEM 2020 RANGOLI COMPETITION

14 Jan 2020



**Student Coordinators**  
**Prajakta (TE COMP)**  
**Kiran (SE IT)**

**Shreya (SE ELE)**

**Staff Coordinators**  
**Prof Jagruti More**  
**Prof Jyoti katela**



  
**PRINCIPAL**  
THEEM COLLEGE OF ENGINEERING  
At Village Binsgaon, Borsar Chittaur Dist.  
Boisar (East) Tal. & Dist. Palghar.



H. J. THIM TRUST'S  
**Theem College of Engineering, Boisar**  
Approved by AICTE (New Delhi) Government of Maharashtra & DTE  
Affiliated to University of Mumbai Est.: - 2009 - 2010

# Jashn-e-Theem-2020

## List of Winner of Individual Event

Category: Technical/ Sports/ Cultural (Tick any one)

Date: 14/1/20

Name of Event: Rangoli

Name of Winner: (In Capital Letters Only)

Gawade Shreya Janardhan

Theme (if any):

Branch: IT

Year: BE

Mob. No.

Name of 1<sup>st</sup> Runner-Up: In Capital Letters Only)

Koli Prajakta Ashok

Theme (if any):

Branch: EXTC

Year: TE

Mob. No.

Name of 2<sup>nd</sup> Runner-Up: In Capital Letters Only)

Patil Jaice Kiran

Theme (if any):

Branch: ELECTRICAL

Year: TE

Mob. No:

PRINCIPAL  
THEEM COLLEGE OF ENGINEERING  
At Village Betsgaon, Boisar Tal. Chitambar  
Boisar (East) Tal. & Dist. Palghar - 401 301

Event coordinator	Event Head	Received by:	PD Head
Student: <u>Kir</u>	Staff: <u>Falhi</u>	Staff: <u>pnj</u>	Prof. <u>G...</u>







H. J. THIM TRUST'S

## THEEM COLLEGE OF ENGINEERING

### NOTICE

Date: 01/01/2020

All the students are hereby informed that, the college level Athletics (Boys and Girls) events will be starting from 06 Jan 2020. All the interested students should enroll your name as an Individual or Group on or before 03 Jan 2020.

(Entry fees for Individual are Rs 10 and for Group /Team is Rs 40.)

Following Students Coordinators:-

JADHAV KOMAL (TE IT)

SHRUTI PATIL(SE EXTC)

PAL RAHUL (TE COMP)

SIMRAN (TE COMP)

#### Staff Coordinator

Prof . N G Hiremath

Prof . Harshad R.

Mr. Neetishkumar

Mrs. Sayali Patil

Mrs. Surekha Attarde

#### Sport Coordinator

Prof. Ansar shaikh

Prof. Ayaz Bagwan.



**PRINCIPAL**  
THEEM COLLEGE OF ENGINEERING  
At. Village Betegaon, Boisar Chilar Road,  
Boisar (East) Tal. & Dist. Palohar - 411 002.



H. J. THIM TRUST'S

# Theem College of Engineering, Boisar

Approved by AICTE (New Delhi) Government of Maharashtra & DTE  
Affiliated to University of Mumbai Est.: - 2009 - 2010

## Jashn-e-Theem 2020

### List of Winner of Individual Event

Category: Technical/ Sports/ Cultural (Tick any one)

Date: 6/1/20

Name of Event: RUNNING 100 M (Boys)

Name of Winner: (In Capital Letters Only)

**BHOIR BHAVIN ROHIDAS**

Theme (if any):

Branch: COMP

Year: BE

Mob. No. \_\_\_\_\_

Name of 1<sup>st</sup> Runner-Up: In Capital Letters Only)

**Khan Mo Shahid**

Theme (if any):

Branch: MECH

Year: TE

Mob. No. \_\_\_\_\_

Name of 2<sup>nd</sup> Runner-Up: In Capital Letters Only)

**CHAVAN AJINKYA SUSHIL**

Theme (if any):

Branch: COMP

Year: FE

Mob. No: \_\_\_\_\_

PRINCIPAL  
THEEM COLLEGE OF ENGINEERING  
No. Village Bolegaon, Boisar - Chikar - Boisar  
(Boisar (East) Tal. & Dist. Palghar - 40)

Event coordinator Student: <u>My</u>	Event Head Staff: <u>Hand</u>	Received by: Staff: <u>K</u>	PD Head Prof. <u>Sgt</u>
---	----------------------------------	---------------------------------	-----------------------------





H. J. THIM TRUST'S

## THEEM COLLEGE OF ENGINEERING

### NOTICE

Date: 01/01/2020

All the students are hereby informed that, the college level Football (Boys) events will be starting from 07 Jan 2020. All the interested students should enroll your name as Group on or before 04 Jan 2020.

(Entry fees for Group /Team is Rs 50.)

Following Students Coordinators:-

BHAIRAGI ABHISHEK (TE COMP)      BHOSALE SARVESH (SE MECH)  
BARDE GAURAV (BE IT)

**Staff Coordinator**

Prof. Abid Manyar

**Sport Coordinator**

Prof. Ansar Shaikh

Prof. Ayaz Bagwan.



  
**PRINCIPAL**  
THEEM COLLEGE OF ENGINEERING  
At Village Bolegaon, Boisar Chithar Road  
Boisar (East) Tal. & Dist. Palohar, AP.



# JASHN-E-THEEM2020

## Football(Boys)

### 07 JAN 2020

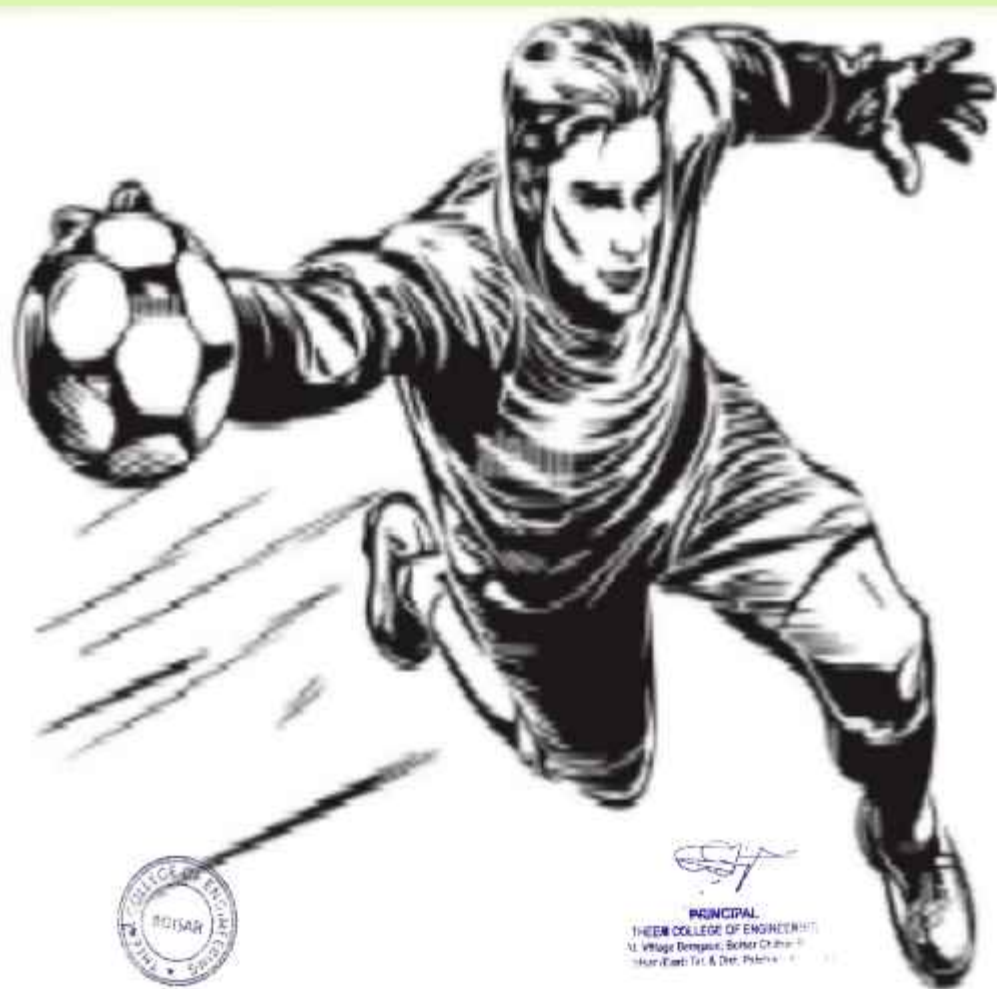

**Student Coordinators**

**Bhairagi Abhishek (TE Comp)**

**Badre Gaurev (BE IT)**

**Bhosale Sarvesh(SE Mech)**

**Staff Coordinators**

**Prof Abid Manjor (8983189619)**



H. J. THIM TRUST'S

# Theem College of Engineering, Boisar

Approved by AICTE (New Delhi) Government of Maharashtra & DTE  
Affiliated to University of Mumbai Est.: - 2009 - 2010

## Jashn-e-Theem 2020

Category: Technical/ Sports/ Cultural (Tick any One)

Date: 7/11/20

Name of Event: FOOTBALL

Theme (if any): \_\_\_\_\_

Name of Winner: (In Capital Letters Only)

Type: Intra/Inter

Sr.No	Name	Branch	Year	Mob. No.
1	ANSARI AFSANA MOHD FAROOK	COMP	BE	
2	BAIRAGI ABHISHEK TAPAN	IT	BE	
3	BARDE GAURAV HARESHWAR	COMP	TE	
4	BHOSALE SARVESH NITIN	IT	TE	
5	CHAMUTE PRATIK SHIVAJI	COMP	SE	
6	ANSARI MOHD DANISH SHAFIQUE AHMAD	COMP	SE	
7	BANGERA ASHISH BHASKAR	CIVIL	TE	
8	BHAGAT DEEPAK ARJUN	MECH	TE	
9	BHARAMBE HITESH JAGANNATH	AUTO	TE	
10	CHAUDHARY OMPRAKASH	CIVIL	BE	
11				

PRINCIPAL  
THEEM COLLEGE OF ENGINEERING  
At Village Betgaon, Boisar Taluka Boisar  
Dist. Palghar - 401 301

Event coordinator Student: <u>_____</u>	Event Head Staff: <u>_____</u>	Received by: Staff: <u>_____</u>	PD Head Prof. <u>_____</u>
--	-----------------------------------	-------------------------------------	-------------------------------





H. J. THIM TRUST'S

# Theem College of Engineering, Boisar

Approved by AICTE (New Delhi) Government of Maharashtra & DTE  
Affiliated to University of Mumbai Est.: - 2009 - 2010

## Jashn-e-Theem 2020

Category: Technical/ Sports/ Cultural (Tick any one)

Date: 7/1/20

Name of Event: FOOTBALL

Theme (if any): \_\_\_\_\_

Name of 1<sup>st</sup> Runner-Up: (In Capital Letters Only)

Type: Intra/Inter

Sr.No	Name	Branch	Year	Mob. No.
1	ANSARI MOHAMMED AREEB MOHAMMED ASHFAQUE	COMP	FE	
2	BARDE HEMANT VIJAY	CIVIL	SE	
3	CHAVAN AJINKYA SUSHIL	MECH	BE	
4	CHOUDHARY DILIP KUPARAM	IT	TE	
5	ANSARI MOHAMMED AREEB MOHAMMED ASHFAQUE	CIVIL	TE	
6	BARDE HEMANT VIJAY	ETRX	BE	
7	BHOIR HITESH VINAYAK	IT	BE	
8	JAIWAR SANDEEP KUMAR RAMJI	IT	SE	
9	GUPTA SUDHEER GULAB	ETRX	TE	
10	DAS CHANDAN RAVINDRA	MECH	TE	
11				

PRINCIPAL  
THEEM COLLEGE OF ENGINEERING  
At Village Beteagan, Boisar Chitambar  
Boisar (East) Tal. & Dist. Palghat - 686 012

Event coordinator Student: <u>may</u>	Event Head Staff: <u>Haha</u>	Received by: Staff: <u>[Signature]</u>	PD Head Prof. <u>[Signature]</u>
--	----------------------------------	---	-------------------------------------







H. J. THIM TRUST'S

## THEEM COLLEGE OF ENGINEERING

### NOTICE

Date: 02/03/2020

All the students are hereby informed that, the college level Throwball (Girls) events will be starting from 07 Jan 2020. All the interested students should enroll your name as Group on or before 05 Mar 2020.

(Entry fees for Individual are Rs 10 and for Group /Team is Rs 20.)

Following Students Coordinators:-

ANISHA (SE COMP)

DURGA(BE CIVIL)

SALONI (BE CIVIL)

RAKHI(BE IT)

#### Staff Coordinator

Prof . Sonali kartik

#### Sport Coordinator

Prof. Ansar shaikh

Prof. Ayaz Bagwan.



**PRINCIPAL**  
THEEM COLLEGE OF ENGINEERING  
At. Village Betegaon, Boisar Chiltar Rd.  
Boisar (East) Tal. & Dist. Palohar - 391 140

**JASHN-E-THEEM 2020**

**THROWBALL**

**7 JAN 2020**



**Student Coordinators**

**Anisha (SE COMP)**

**Saloni (BE Civil)**

**Durga (BE CIVIL)**

**Rakhi (BE IT)**

**Staff Coordinators**

**Prof Sonali Kartik**



  
**PRINCIPAL**  
THE COLLEGE OF ENGINEERING  
DURGAM CHERUVU, HYDRABAD  
ESTD. 1981



H. J. THIM TRUST'S

# Theem College of Engineering, Boisar

Approved by AICTE (New Delhi) Government of Maharashtra & DTE  
Affiliated to University of Mumbai Est.: - 2009 - 2010

## Jashn-e-Theem 2020

Category: Technical/ Sports/ Cultural (Tick any one)

Date: 9/1/20

Name of Event: THROWBALL (GIRLS)

Theme (if any): \_\_\_\_\_

Name of Winner: (In Capital Letters Only)

Type: Intra/Inter

Sr.No	Name	Branch	Year	Mob. No.
1	GILANI ANISA SALIM	EXTC	BE	
2	JHA RAKHI NAGENDRA	EXTC	BE	
3	BHOI DURGA GURUDATT	EXTC	BE	
4	PIMPLE SALONI DEEPAK	COMP	SE	
5	GAIKWAD PRAJYOTI PRATAPSIH	COMP	SE	
6				
7				
8				
9				
10				

PRINCIPAL  
THEEM COLLEGE OF ENGINEERING  
St. Village Betegeon, Boisar Chikhar Rd.  
Boisar (East) Tal. & Dist. Palghar. (M)

Event coordinator Student: <u>May</u>	Event Head Staff: <u>Hand</u>	Received by: Staff: <u>Hand</u>	PD Head Prof. <u>Hand</u>
--	----------------------------------	------------------------------------	------------------------------







H. J. THIM TRUST'S

# Theem College of Engineering, Boisar

Approved by AICTE (New Delhi) Government of Maharashtra & DTE  
Affiliated to University of Mumbai Est.: - 2009 - 2010

## Jashn-e-Theem 2020

### List of Winner of Individual Event

Category: Technical/ Sports/ Cultural (Tick any one)

Date: 6/1/20

Name of Event: RUNNING 100 M (Girls)

Name of Winner: (In Capital Letters Only)

**Chaudhari Dhanashree Vasant**

Theme (if any):

Branch: ELECT

Year: BE

Mob. No.

Name of 1<sup>st</sup> Runner-Up: In Capital Letters Only)

**Jadhav Komal Vasudev**

Theme (if any):

Branch: COMP

Year: SE

Mob. No.

Name of 2<sup>nd</sup> Runner-Up: In Capital Letters Only)

**Chavan Namrata Atmaram**

Theme (if any):

Branch: IT

Year: TE

Mob. No:

PRINCIPAL  
THEEM COLLEGE OF ENGINEERING  
At Village Belegao, Boisar Taluka, Dist. Palghar - 401 301  
(Near I.E.T. & D.H. Patil - II)

Event coordinator	Event Head	Received by:	PD Head
Student: <u>May</u>	Staff: <u>Harsh</u>	Staff: <u>①</u>	Prof. <u>S. S. S.</u>





H. J. THIM TRUST'S

# Theem College of Engineering, Boisar

Approved by AICTE (New Delhi) Government of Maharashtra & DTE  
Affiliated to University of Mumbai Est.: - 2009 - 2010

## Jashn-e-Theem 2020

### List of Winner of Individual Event

Category: Technical/ Sports/ Cultural (Tick any one)

Date: 6/1/20

Name of Event: RUNNING 200 M (Boys)

Name of Winner: (In Capital Letters Only)

**Nirban Ruman Usman**

Theme (if any):

Branch: CIVIL

Year: SE

Mob. No.

Name of 1<sup>st</sup> Runner-Up: In Capital Letters Only)

**Chauhan Pritam Dinesh**

Theme (if any):

Branch: MECH

Year: FE

Mob. No.

Name of 2<sup>nd</sup> Runner-Up: In Capital Letters Only)

**Jadav Ketan Subhash**

Theme (if any):

Branch: ELECT

Year: BE

Mob. No:

PRINCIPAL  
THEEM COLLEGE OF ENGINEERING  
St. Village Boregaon, Boisar Chikar Road  
Boisar (East Tal. & Dist. Palghar - 401 301)

Event coordinator Student: <u>manoj</u>	Event Head Staff: <u>Hard</u>	Received by: Staff: <u>RD</u>	PD Head Prof. <u>SPK</u>
--	----------------------------------	----------------------------------	-----------------------------





H. J. THIM TRUST'S

# Theem College of Engineering, Boisar

Approved by AICTE (New Delhi) Government of Maharashtra & DTE  
Affiliated to University of Mumbai Est.: - 2009 - 2010

## Jashn-e-Theem 2020

### List of Winner of Individual Event

Category: Technical/ Sports/ Cultural (Tick any one)

Date: 6/1/20

Name of Event: LONG JUMPS (Boys)

Name of Winner: (In Capital Letters Only)

**Nirban Ruman Usman**

Theme (if any):

Branch: CIVIL

Year: SE

Mob. No.

Name of 1<sup>st</sup> Runner-Up: In Capital Letters Only)

**Kadam Advait Vivek**

Theme (if any):

Branch: AUTO

Year: BE

Mob. No.

Name of 2<sup>nd</sup> Runner-Up: In Capital Letters Only)

**Pal Rahul Rajesh**

Theme (if any):

Branch: MECH

Year: SE

Mob. No:

PRINCIPAL  
THEEM COLLEGE OF ENGINEERING  
At Village Belegani, Boisar District Palghar  
Boisar (East) Tal. & Dist. Palghar - 40

Event coordinator Student: <u>May</u>	Event Head Staff: <u>Harsh</u>	Received by: Staff: <u>(Signature)</u>	PD Head Prof. <u>(Signature)</u>
--	-----------------------------------	---	-------------------------------------







H. J. THIM TRUST'S

# Theem College of Engineering, Boisar

Approved by AICTE (New Delhi) Government of Maharashtra & DTE  
Affiliated to University of Mumbai Est.: - 2009 - 2010

## Jashn-e-Theem 2020

### List of Winner of Individual Event

Category: Technical/ Sports/ Cultural (Tick any one)

Date: 6/1/20

Name of Event: LONG JUMPS (Girls)

Name of Winner: (In Capital Letters Only)

**Mhatre Tejashree Kailas**

Theme (if any):

**Branch: IT**

**Year: TE**

**Mob. No.**

Name of 1<sup>st</sup> Runner-Up: In Capital Letters Only)

**Singh Ankita Anilkumar**

Theme (if any):

**Branch: COMP**

**Year: SE**

**Mob. No.**

Name of 2<sup>nd</sup> Runner-Up: In Capital Letters Only)

**Umbarsada Mayuri Anant**

Theme (if any):

**Branch: COMP**

**Year: SE**

**Mob. No:**

PRINCIPAL  
THEEM COLLEGE OF ENGINEERING  
At Village Belgaon, Boisar Taluka Talasari  
Boisar (East) Tal. & Dist. Palghar - 401 301

Event coordinator Student: <u>Wavy</u>	Event Head Staff: <u>hurd</u>	Received by: Staff: <u>Q</u>	PD Head Prof. <u>SPC</u>
---	----------------------------------	---------------------------------	-----------------------------





H. J. THIM TRUST'S

# Theem College of Engineering, Boisar

Approved by AICTE (New Delhi) Government of Maharashtra & DTE  
Affiliated to University of Mumbai Est.: - 2009 - 2010

## Jashn-e-Theem 2020

### List of Winner of Individual Event

Category: Technical/ Sports/ Cultural (Tick any one)

Date: 6/1/20

Name of Event: DISCUSS THROW (Boys)

Name of Winner: (In Capital Letters Only)

**Patel Mahendra Omprakash**

Theme (if any):

Branch: EXTC

Year: TE

Mob. No.

Name of 1<sup>st</sup> Runner-Up: In Capital Letters Only)

**Bari Daywat Rakesh**

Theme (if any):

Branch: MECH

Year: BE

Mob. No.

Name of 2<sup>nd</sup> Runner-Up: In Capital Letters Only)

**Kadam Mayur Subhash**

Theme (if any):

Branch: ELECT

Year: SE

Mob. No:

PRINCIPAL  
THEEM COLLEGE OF ENGINEERING  
At Village Bilegaon, Boisar Tal. Boisar Dist. Palghar  
Palghar (East) Tal. & Dist. Palghar - 401 305

Event coordinator	Event Head	Received by:	PD Head
Student: <u>may</u>	Staff: <u>Harsh</u>	Staff: <u>[Signature]</u>	Prof. <u>[Signature]</u>





H. J. THIM TRUST'S

# Theem College of Engineering, Boisar

Approved by AICTE (New Delhi) Government of Maharashtra & DTE  
Affiliated to University of Mumbai Est.: - 2009 - 2010

## Jashn-e-Theem 2020

### List of Winner of Individual Event

Category: Technical/ Sports/ Cultural (Tick any one)

Date: 6/1/20

Name of Event: DISCUSS THROW (Girls)

Name of Winner: (In Capital Letters Only)

**Patil Samiksha Jitendra**

Theme (if any):

Branch: CIVIL

Year: BE

Mob. No.

Name of 1<sup>st</sup> Runner-Up: In Capital Letters Only)

**Patil Simran N.**

Theme (if any):

Branch: IT

Year: TE

Mob. No.

Name of 2<sup>nd</sup> Runner-Up: In Capital Letters Only)

**Yadav Soni Trilochan**

Theme (if any):

Branch: IT

Year: TE

Mob. No:

PRINCIPAL  
THEEM COLLEGE OF ENGINEERING  
At Village Botegaon, Boisar Taluka Boisar  
Boisar (East) Tal. & Dist. Palanpur - 39

Event coordinator Student: <u>Meiy</u>	Event Head Staff: <u>Huzaf</u>	Received by: Staff: <u>[Signature]</u>	PD Head Prof. <u>[Signature]</u>
---	-----------------------------------	---	-------------------------------------







H. J. THIM TRUST'S

# Theem College of Engineering, Boisar

Approved by AICTE (New Delhi) Government of Maharashtra & DTE  
Affiliated to University of Mumbai Est.: - 2009 - 2010

## Jashn-e-Theem 2020

### List of Winner of Individual Event

Category: Technical/ Sports/ Cultural (Tick any one)

Date: 8/1/20

Name of Event: SHOT PUT (Boys)

Name of Winner: (In Capital Letters Only)

**Patel Pritesh Ganeshbhai**

Theme (if any):

**Branch: IT**

**Year: TE**

**Mob. No.**

Name of 1<sup>st</sup> Runner-Up: In Capital Letters Only)

**Phadatare Girish Hanmant**

Theme (if any):

**Branch: CIVIL**

**Year: BE**

**Mob. No.**

Name of 2<sup>nd</sup> Runner-Up: In Capital Letters Only)

**Srirag Sreekumar**

Theme (if any):

**Branch: AUTO**

**Year: SE**

**Mob. No:**

PRINCIPAL  
THEEM COLLEGE OF ENGINEERING  
At Village Biregaon, Borar Chimar Road,  
Boisar (East) Tal. & Dist. Palghar - 401 301

Event coordinator Student: <u>MAN</u>	Event Head Staff: <u>hurd</u>	Received by: Staff: <u>[Signature]</u>	PD Head Prof. <u>[Signature]</u>
--	----------------------------------	---	-------------------------------------





H. J. THIM TRUST'S  
**Theem College of Engineering, Boisar**  
Approved by AICTE (New Delhi) Government of Maharashtra & DTE  
Affiliated to University of Mumbai Est.: - 2009 - 2010

# Jashn-e-Theem 2020

## List of Winner of Individual Event

**Category:** Technical/ Sports/ Cultural (Tick any one)

Date: 8/1/20

**Name of Event:** SHOT PUT (Girls)

**Name of Winner:** (In Capital Letters Only)

**Patil Shruti Shivaji**

Theme (if any):

**Branch:** COMP

**Year:** BE

**Mob. No.**

**Name of 1<sup>st</sup> Runner-Up:** In Capital Letters Only)

**Jadyar Ketaki Suryakant**

Theme (if any):

**Branch:** CIVIL

**Year:** SE

**Mob. No.**

**Name of 2<sup>nd</sup> Runner-Up:** In Capital Letters Only)

**Patil Shivani Manoj**

Theme (if any):

**Branch:** CIVIL

**Year:** TE

**Mob. No:**

**PRINCIPAL**  
THEEM COLLEGE OF ENGINEERING  
Village Betegeon, Boisar Chitthar B...  
Boisar (Erat) Tal. & Dist. Palghar - 401 201

Event coordinator	Event Head	Received by:	PD Head
Student: <u>Meg</u>	Staff: <u>[Signature]</u>	Staff: <u>[Signature]</u>	Prof. <u>[Signature]</u>





H. J. THIM TRUST'S

# Theem College of Engineering, Boisar

Approved by AICTE (New Delhi) Government of Maharashtra & DTE  
Affiliated to University of Mumbai Est.: - 2009 - 2010

## Jashn-e-Theem 2020

### List of Winner of Individual Event

Category: Technical/ Sports/ Cultural (Tick any one)

Date: 8/1/20

Name of Event: JEWELIN (Girls)

Name of Winner: (In Capital Letters Only)

**Mallah Julee Laxman**

Theme (if any):

Branch: EXTC

Year: TE

Mob. No.

Name of 1<sup>st</sup> Runner-Up: In Capital Letters Only)

**Jadyar Ketaki Suryakant**

Theme (if any):

Branch: CIVIL

Year: SE

Mob. No.

Name of 2<sup>nd</sup> Runner-Up: In Capital Letters Only)

**Siddiqui Saaima Neyaz**

Theme (if any):

Branch: IT

Year: TE

Mob. No:

  
PRINCIPAL  
THEEM COLLEGE OF ENGINEERING  
At: Village Beteagan, Boisar Chitambar Road  
Boisar (East) Tal. & Dist. Palghar - 401 301

Event coordinator	Event Head	Received by:	PD Head
Student: <u>MVJ</u>	Staff: <u>Harsh</u>	Staff: <u>[Signature]</u>	Prof. <u>[Signature]</u>







H. J. THIM TRUST'S

# Theem College of Engineering, Boisar

Approved by AICTE (New Delhi) Government of Maharashtra & DTE  
Affiliated to University of Mumbai Est.: - 2009 - 2010

## Jashn-e-Theem-2020

### List of Winner of Individual Event

Category: Technical/ Sports/ Cultural (Tick any one)

Date: 9/1/20

Name of Event: JEWELIN (Boys)

Name of Winner: (In Capital Letters Only)

**Jaiswal Ravi Kalluprasad**

Theme (if any):

Branch: MECH

Year: BE

Mob. No.

Name of 1<sup>st</sup> Runner-Up: In Capital Letters Only)

**Gaykwad Nayan Dipak**

Theme (if any):

Branch: MECH

Year: BE

Mob. No.

Name of 2<sup>nd</sup> Runner-Up: In Capital Letters Only)

**Singh Shashank Nagendrapratap**

Theme (if any):

Branch: CIVIL

Year: TE

Mob. No:

  
PRINCIPAL  
THEEM COLLEGE OF ENGINEERING  
At Village Boregaon, Boisar City Tal. Boisar (East) Tal. & Dist. Palghar

Event coordinator Student: <u>Maly</u>	Event Head Staff: <u>Horst</u>	Received by: Staff: <u>[Signature]</u>	PD Head Prof. <u>[Signature]</u>
---	-----------------------------------	---	-------------------------------------



H. J. THIM TRUST'S

# Theem College of Engineering

BOISAR (E), DIST. PALGHAR



## Certificate of Appreciation

Awarded to

Mr./Miss Bhoi Durga Guresdatt

Course EXTC Year BE

actively Participated in conducting JASHN-E-THEEM as Throwball (winners)  
GMS  
in the year 2020

7/1/2020  
Date

  
Co-ordinators

  
Principal

PRINCIPAL  
THEEM COLLEGE OF ENGINEERING  
At. Village Betegda  
Boisar (East) Tal. & Dist. Palghar





H. J. THIM TRUST'S

# Theem College of Engineering

BOISAR (E), DIST. PALGHAR



## Certificate of Appreciation

Awarded to

Mr./Miss Chavan Ajinkya Sushil



Course Mechanical Engg Year BE

actively Participated in conducting JASHN-E-THEEM as Football (1st runner up)  
in the year \_\_\_\_\_



7/1/2020  
Date

  
Co-ordinators

  
  
Principal





H. J. THIM TRUST'S

# Theem College of Engineering

BOISAR (E), DIST. PALGHAR



## Certificate of Appreciation

Awarded to

Mr./Miss Bande Gaurav Harshwan

Course Comp Brngs Year TE

actively Participated in conducting JASHIN-E-THEEM as Football (winner)

in the year 2020



7/1/2020

Date

Co-ordinator

PRINCIPAL

Principal

THEEM COLLEGE OF ENGINEERING  
At Village Betegaon, Boisar Chikhar  
Boisar (East) Tal. & Dist. Palghar - 407 505



H. J. THIM TRUST'S

# Theem College of Engineering

BOISAR (E), DIST. PALGHAR



## Certificate of Appreciation

Awarded to

Mr./Miss Bande Gaurav Harshwas

Course Comp Bngg Year TE

actively Participated in conducting JASHN-E-THEEM as Football (winner)  
in the year 2020



7/1/2020  
Date

  
Co-ordinators

  
Principal



PRINCIPAL  
THEEM COLLEGE OF ENGINEERING  
At Village Betegara, Dist. Palghar  
Boisar (East) Tal. & Dist. Palghar



H. J. THIM TRUST'S

# Theem College of Engineering

BOISAR (E), DIST. PALGHAR



## Certificate of Appreciation

Awarded to

Mr./Miss Bangera Ashish Bhaskar

Course Civil Engg. Year TE

actively Participated in conducting JASHN-E-THEEM as Football (winner)  
in the year 2020

7/1/2020  
Date

  
Co-ordinator

  
Principal



PRINCIPAL  
THEEM COLLEGE OF ENGINEERING  
At Village Betegaon, Boisar Chitambar Road,  
Boisar (East) Tal. & Dist. Palghar.



H. J. THIM TRUST'S

# Theem College of Engineering

BOISAR (E), DIST. PALGHAR



## Certificate of Appreciation

Awarded to

Mr./Miss Bhois Bhavan RohidasCourse Computer Engg Year BEactively Participated in conducting JASHN-E-THEEM as Running Inm (Winner)in the year 20206/1/2020

Date

Co-ordinators

Principal



PRINCIPAL  
THEEM COLLEGE OF ENGINEERING  
Village Betegaon, Boisar Chillar Road  
Boisar (East) Tal. & Dist. Palghar (E)



H. J. THIM TRUST'S

# Theem College of Engineering

BOISAR (E), DIST. PALGHAR



## Certificate of Appreciation

Awarded to

Mr./Miss Bhagat Juy Anand

Course Electrical Engg Year FE

actively Participated in conducting JASHN-E-THEEM as Bollywood day (1st runner up)  
in the year 2020



[Signature]  
Co-ordinators

[Signature]  
Principal



PRINCIPAL  
THEEM COLLEGE OF ENGINEERING  
Village: Bolegaon, Boisar, Tal. Palghar,  
Dist. Palghar



H. J. THIM TRUST'S

# Theem College of Engineering

BOISAR (E), DIST. PALGHAR



## Certificate of Appreciation

Awarded to

Mr./Miss Khan Rizwan Islamkhan

Course Information Technology Year FE

actively Participated in conducting JASHN-E-THEEM as Intra Singing (winner)

in the year 2020

16/1/2020

Date



Co-ordinators

PRINCIPAL

THEEM COLLEGE OF ENGINEERING

At Village Beteasait, Boisar Chittha  
Boisar (East) Tal. & Dist. Palghar

Principal





H. J. THIM TRUST'S

# Theem College of Engineering

BOISAR (E), DIST. PALGHAR



## Certificate of Appreciation

Awarded to

Mr./Miss Kazi Asiya Nisar Ahmed

Course Civil Engg Year DSE

actively Participated in conducting JASHN-E-THEEM as Face Maker (1st runner up)  
in the year 2020

15/1/2020  
Date



[Signature]  
Co-ordinators

[Signature]  
Principal

PRINCIPAL  
THEEM COLLEGE OF ENGINEERING  
At. Village Betegaon, Boisar  
(East) Tal. & Dist. Palghar



H. J. THIM TRUST'S

# Theem College of Engineering

BOISAR (E), DIST. PALGHAR



## Certificate of Appreciation

Awarded to

Mr./Miss Parman Mitali Babulal

Course Electrical Engg Year TE

actively Participated in conducting JASHN-E-THEEM as Mehendi Competition (winner)

in the year 2020



14/1/2020  
Date

Co-ordinators

Principal



PRINCIPAL  
THEEM COLLEGE OF ENGINEERING  
At. Village Betegaon, Boisar (East) Tal. & Dist. Palghar



H. J. THIM TRUST'S

# Theem College of Engineering

BOISAR (E), DIST. PALGHAR



## Certificate of Appreciation

Awarded to

Mr./Miss Pawan Jyoti Mahadu

Course Computn Engg Year TE

actively Participated in conducting JASHN-E-THEEM as Cook without Fire (2<sup>nd</sup> runner up)

in the year 2020



13/11/2020  
Date

Co-ordinators

Principal

PRINCIPAL  
THEEM COLLEGE OF ENGINEERING  
Village Bolegaon, Boisar (E), Dist. Palghar





H. J. THIM TRUST'S

# Theem College of Engineering

BOISAR (E), DIST. PALGHAR



## Certificate of Appreciation

Awarded to

Mr./Miss Bhois Hitesh Vinayak

Course Computy Enng. Year TE

actively Participated in conducting JASHN-E-THEEM as Traditional Day (1<sup>st</sup> Runner up)  
in the year 2020



15/1/2020  
Date

  
Co-ordinators

  
PRINCIPAL  
THEEM COLLEGE OF ENGINEERING  
At Village Buzegaon, Boisar Chitli  
Palghar (East) Tal. & Dist. Palghar  
Principal



H. J. THIM TRUST'S

# Theem College of Engineering

BOISAR (E), DIST. PALGHAR



## Certificate of Appreciation

Awarded to

Mr./Miss Bhatalekar Shreyas Prashant

Course Information Technology Year 13E

actively Participated in conducting JASHN-E-THEEM as Retro day (winner)

in the year 2020



11/2020

Date

Co-ordinators

PRINCIPAL  
THEEM COLLEGE OF ENGINEERING  
At Village Botogaoon, Bolser Chiltar P  
Palghar (East) Tal. & Dist. Palghar - 41





H. J. THIM TRUST'S

# Theem College of Engineering

BOISAR (E), DIST. PALGHAR



## Certificate of Appreciation

Awarded to

Mr./Miss Kanade Riddhesh Dimesh

Course EXTC Year TE

actively Participated in conducting JASHN-E-THEEM as stand up Comedy

in the year 2020

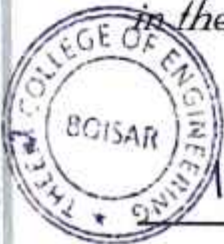

17/1/2020

Date

Co-ordinators

Principal

PRINCIPAL  
THEEM COLLEGE OF ENGINEERING  
Village: Boisar, Tal. Palghar, Dist. Palghar





H. J. THIM TRUST'S

# Theem College of Engineering

BOISAR (E), DIST. PALGHAR



## Certificate of Appreciation

Awarded to

Mr./Miss Dalvi Shubham Yashwant

Course Computer Engg. Year 2020 (BE)

actively Participated in conducting JASHN-E-THEEM as stand up comedy

in the year 2020



7/1/2020  
Date

Co-ordinator

Principal



PRINCIPAL  
THEEM COLLEGE OF ENGINEERING  
At Village Beteegaon, Boisar  
Palghar (East) Tal. & Dist. Palghar



RANGOLI

14/01/2020



  
PRINCIPAL  
THEEM COLLEGE OF ENGINEERING  
St. Village Botegaon, Boisar Chitwan Rd.  
Boisar (East) Tal. & Dist. Palanpur - 385 001



MEHANDI

14/01/2020



PRINCIPAL  
THEEM COLLEGE OF ENGINEERING  
St. Village Botegaon, Boisar Chitwan Road  
Boisar (East) Tal. & Dist. Patanwar - 42





MEHANDI

14/01/2020



PRINCIPAL  
THEEM COLLEGE OF ENGINEERING  
St. Village Batogaon, Boisar Chikher Road,  
Boisar (East) Tal. & Dist. Patkote - 422 001



MEHANDI  
14/01/2020



  
PRINCIPAL  
THEEM COLLEGE OF ENGINEERING  
St. Village Botegaon, Boisar Chikher Road  
Boisar (East) Tal. & Dist. Palanpur - 384 001





RANGOLI

14/01/2020



PRINCIPAL  
THEEN COLLEGE OF ENGINEERING  
Village Boregaon, Boisar Chitram District  
Boisar (East) Tal. & Dist. Palghar





RANGOLI  
14/01/2020



  
PRINCIPAL  
THEEM COLLEGE OF ENGINEERING,  
St. Village Breegaon, Boisar Chitthar Road,  
Chitthar (East) Tal. & Dist. Palghar - 407 001



RANGOLI  
14/01/2020



  
PRINCIPAL  
THEM COLLEGE OF ENGINEERING  
St. Village Boregaon, Boisar Chilar Road  
Boisar (East) Tal. & Dist. Palahar - 721101

A.Y

2018-19





# H. J. THIM TRUST'S THEEM COLLEGE OF ENGINEERING

Approved by AICTE (New Delhi), Government of Maharashtra & DTE, Affiliated to University of Mumbai & MSBTE, Estd. 2009  
 NAAC Accredited with B+ Grade

Village Betagaon, Boisar Chilhar Road, Boisar (E), Tal. & Dist.: Palghar - 401 501.

Tel.: (02525) 284 909 • Fax : (02525) 284 927 • Email : info@theemcoe.org • Website : www.theemcoe.org

Year 1 (2018-19)			
Date of event/activity (DD-MM-YYYY)	Name of the event/activity	Name of the organising institution	Name of the student participated
<b>SPORTS (Jashn -E- Theem)</b>			
10/1/2019	volleyball		ayaz ranasariya,hitesh pal,shaal sujee,Ritwik shukla
12/1/2019	Football		amit chauhan,sachin pathak,karan shetty,sagar pawar
14/1/2019	kho kho		Vaibhav rasal,raza,javelin ali,godke sagar,rohit pandey,sufiyaan
15/01/2019	Box cricket		prajatta koli ,bhakti yadav,rutika kalhe,utkarsha kini,yashaswi bari
14/1/2019	tug of war		Pratik bhagat,Sanket jadhav,Kunal agre,Shreyas bagwe,parag raut
15/1/2019	Box cricket (Girls)		iram gawandi,samiksha patil,ankita kadam,disha ahiran,priyanka
12/1/2019	cricket(open)		sanket s.kadam,rohit katkar,amit,aniket bore,jiggesh,akash ranpise
16/1/2019	badminton		santosh s.pandey,sagar bhavsar,shubham more,shreyas bafflekar,nidhi , riddhi rathod
11/1/2019	carrom		shaikh hazef zahurmiya,jaiee Kiran patil,vijo joy,kaivalya yogesh
14/1/2019	blind man		ankit yadav,kajal sankhe,shreya patil,kajal h sanke
14/1/2019	blind fold		shubham mishra,nimesh more,bhavika gode
12/1/2019	athletics (girls)		iram gawandi,samiksha patil,ankita kadam,disha ahiran,priyanka
15/1/2019	throwball (Girls)		Akshay p sawal,Furkan shaikh,shubham mishra,ankit yadav,iram gawandi
11/1/2019	chess		krushita m.ambore,jaiee K.patil,abdulla iqbal,abhinav dinesh mishra
14/1/2019	kabaddi		kirnali patil,iram gawandi ,samiksha patil,gauri patil,atik khan
12/1/2019	athletics (boys)		Pratik bhagat,Sanket jadhav,Kunal agre,Shreyas bagwe,parag raut
<b>Cultral (Jashn -E- Theem)</b>			
10/1/2019	Traditional +Rose day		Alisha shaikh,Raj Rajeshwar,Aditi Tamore,Kaivalya Kawali,Anjali,Aditya Hinukale
11/1/2019	Retro+chocolate day		sona yadav,romil arora,nikat khan,kaivalya kawli,unnati patil,naveen garge
12/1/2019	mismatch day		Aditi tamore,sunny arora,anjali purohit,Rizwan Khan,saara sarode,romil arora
14/1/2019	saree/formal day		Shweta pawar,vijo joy,Shruti lade, atik khan, nikat khan, Mohit pandey

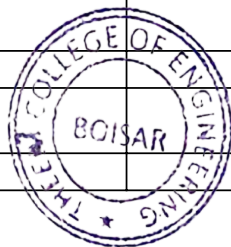

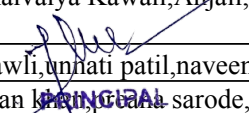
  
 THEEM COLLEGE OF ENGINEERING  
 Village Betagaon, Boisar Chilhar Road,  
 Boisar (East) Tal. & Dist. Palghar - 401 501.

10/1/2019	mehandi		jannat shaikh,ayesha khan,masuma shaikh
14/1/2019	best out of waste		aditi bhoir,Yogesh samsher,vivek singh,aquib shaikh,anasari shabazz,Mo. Zulfakas ali
15/01/2019	poster painting		mansi kiran gharat,bhavika gode,shah mohd sameer
16/1/2019	rangoli		manasi gharat,bhavika gharat,Archana patil
17/1/2019	floral decoration		preeti verma,jagruti patil,prerana sarode,shruti lade
17/1/2019	singing(compitation)		Jaydeep shiyara,raj savita,pal sachin
18/01/2019	drama		umar khan,Saurabh gharat,santosh s.pandey,akash jadhav
18/1/2019	dance		Kapil j rathod,sachin singh,sunny gupta,mohit pandey,krishna bari



  
**PRINCIPAL**  
**THEEM COLLEGE OF ENGINEERING**  
**At Village Betegaon, Boisar Chithar Road**  
**Boisar (East) Tal. & Dist. Patghar - 401 501**

## Schedule

<b>Jash n Theem Sports -Athlon- 2019</b>							
EVENTS	Initial Maches				Semi Finals		Final
	Date						
Cricket	09-01-2019	10-01-2019	11-01-2019	12-01-2019		15-01-2019	17-01-2019
Cricket(BOX)	11-01-2019	12-01-2019			14-01-2019	15-01-2019	17-01-2019
FootBall	12-01-2019				14-01-2019	15-01-2019	17-01-2019
Valley Ball	11-01-2019	12-01-2019			14-01-2019	15-01-2019	17-01-2019
Throw Ball(Girls)	11-01-2019	12-01-2019			14-01-2019	15-01-2019	
Kabbadi(Girls)		12-01-2019					12-01-2019
Kabaddi	11-01-2019	12-01-2019			14-01-2019	15-01-2019	17-01-2019
Kho Kho(Girls)	11-01-2019	12-01-2019			14-01-2019	15-01-2019	
Kho Kho	11-01-2019	12-01-2019			14-01-2019	15-01-2019	
Badminton(Girls)	14-01-2019						
Badminton(Boys)	10-01-2019	11-01-2019	12-01-2019				
Tug Of War	14-01-2019						
Blind Fold & Blind HitMan	14-01-2019	15-01-2019					
Athletics Event	12-01-2019						



**PRINCIPAL**  
**THEEM COLLEGE OF ENGINEERING**  
 At Village Beteagan, Borsar Chhitar B.P.  
 Dist. (East) Tal. & Dist. Palsha - 40





H.J. Thim Trust's

**THEEM COLLEGE OF ENGINEERING**

BoisarChilhar Road, Boisar (E), Tal.Palghar, Dist.Palghar 401 501

Tel.: (02525) 284 909, Fax. : (02525) 284 927

**DATE: 09/10/2018**

**CIRCULAR**

All HOD's and Interested Students Class representative Members are hereby informed that, they should gather for Meeting in the Second Floor Seminar Hall on 09/10/2018 at 4.00 p.m.

Regarding: JASHN –E- THIM.

After this there will be a meeting of all HOD's and T.P.O.members at.05<sup>th</sup> Clock.

PRINCIPAL  
THEEM COLLEGE OF ENGINEERING  
Village Selvaon, Boisar Chikhar Road,  
Boisar (East) Tal. & Dist. Palghar



(Dr.N.K.Rana)

Principal



H.J. Thim Trust's.

## **THEEM COLLEGE OF ENGINEERING**

BoisarChilhar Road, Boisar (E), Tal.Palghar, Dist.Thane 401 501

Tel.: (02525) 284 909, Fax. : (02525) 284 927

Date: 14-01-2019

### **CIRCULAR**

All the staff members are requested to present on 16-01-2019 & 17-01-2019 for Inauguration and Valedictory program **JASHN-E-THEEM 2019**.

#### **❖ Inauguration program – 16-01-2019**

Timing: 10: a.m. - Technical (Foyer)

Timing: 10:30 a.m.

Prize Distribution academic Year - Seminar Hall Second Flower.

#### **❖ Junior Scientist – 17-01-2019**

Timing: 10:30 a.m. – Inauguration (BEE Lab.)

Timing: 10:30 a.m. to 3.00 p.m. Evaluation & Monitoring

#### **❖ Valedictory & Cultural program. – 17-01-2019**

Timing: 4.00 p.m. – Valedictory program.

Timing: 4.30 p.m. – Cultural program.

  
PRINCIPAL  
THEEM COLLEGE OF ENGINEERING  
41, Village Betagan, Boisar Chilhar Road,  
Boisar (East) Tal. & Dist. Palghar - 401 501



  
(Dr.N.K.Rana)  
Director

# ATHLON 2019 SCHEDULE

## GROUP-A

DAY 1

DAY 3

11/01/2019



DAY 5

17/01/2019

17/01/2019

17/01/2019

17/01/2019

17/01/2019

17/01/2019

17/01/2019

17/01/2019

17/01/2019

17/01/2019

17/01/2019

17/01/2019

17/01/2019

17/01/2019

17/01/2019

17/01/2019

17/01/2019

17/01/2019

17/01/2019

17/01/2019

17/01/2019

17/01/2019

17/01/2019

17/01/2019

17/01/2019

17/01/2019

17/01/2019

17/01/2019

17/01/2019

17/01/2019

17/01/2019

17/01/2019

17/01/2019

17/01/2019

17/01/2019

17/01/2019

17/01/2019

17/01/2019

17/01/2019

17/01/2019

17/01/2019

17/01/2019

17/01/2019

17/01/2019

17/01/2019

17/01/2019

17/01/2019

17/01/2019

17/01/2019

17/01/2019

17/01/2019

17/01/2019

17/01/2019

17/01/2019

WINNER A  
S.E.(CIVIL)

1st SEMI FINAL  
10:15 A.M.

1st SEMI FINAL  
10:15 A.M.

1st SEMI FINAL  
10:15 A.M.

1st SEMI FINAL  
10:15 A.M.

1st SEMI FINAL  
10:15 A.M.

1st SEMI FINAL  
10:15 A.M.

1st SEMI FINAL  
10:15 A.M.

1st SEMI FINAL  
10:15 A.M.

1st SEMI FINAL  
10:15 A.M.

1st SEMI FINAL  
10:15 A.M.

1st SEMI FINAL  
10:15 A.M.

1st SEMI FINAL  
10:15 A.M.

1st SEMI FINAL  
10:15 A.M.

1st SEMI FINAL  
10:15 A.M.

1st SEMI FINAL  
10:15 A.M.

1st SEMI FINAL  
10:15 A.M.

1st SEMI FINAL  
10:15 A.M.

1st SEMI FINAL  
10:15 A.M.

1st SEMI FINAL  
10:15 A.M.

1st SEMI FINAL  
10:15 A.M.

1st SEMI FINAL  
10:15 A.M.

1st SEMI FINAL  
10:15 A.M.

1st SEMI FINAL  
10:15 A.M.

1st SEMI FINAL  
10:15 A.M.

1st SEMI FINAL  
10:15 A.M.

1st SEMI FINAL  
10:15 A.M.

1st SEMI FINAL  
10:15 A.M.

## GROUP-B

DAY 2

DAY 4

12/01/2019



DAY 5

17/01/2019

17/01/2019

17/01/2019

17/01/2019

17/01/2019

17/01/2019

17/01/2019

17/01/2019

17/01/2019

17/01/2019

17/01/2019

17/01/2019

17/01/2019

17/01/2019

17/01/2019

17/01/2019

17/01/2019

17/01/2019

17/01/2019

17/01/2019

17/01/2019

17/01/2019

17/01/2019

17/01/2019

17/01/2019

17/01/2019

17/01/2019

17/01/2019

17/01/2019

17/01/2019

17/01/2019

17/01/2019

17/01/2019

17/01/2019

17/01/2019

17/01/2019

17/01/2019

17/01/2019

17/01/2019

17/01/2019

17/01/2019

17/01/2019

17/01/2019

WINNER B  
S.E. ELEC

2nd SEMI FINAL  
11:15 A.M.

2nd SEMI FINAL  
11:15 A.M.

2nd SEMI FINAL  
11:15 A.M.

2nd SEMI FINAL  
11:15 A.M.

2nd SEMI FINAL  
11:15 A.M.

2nd SEMI FINAL  
11:15 A.M.

2nd SEMI FINAL  
11:15 A.M.

2nd SEMI FINAL  
11:15 A.M.

2nd SEMI FINAL  
11:15 A.M.

2nd SEMI FINAL  
11:15 A.M.

2nd SEMI FINAL  
11:15 A.M.

2nd SEMI FINAL  
11:15 A.M.

2nd SEMI FINAL  
11:15 A.M.

2nd SEMI FINAL  
11:15 A.M.

2nd SEMI FINAL  
11:15 A.M.

2nd SEMI FINAL  
11:15 A.M.

2nd SEMI FINAL  
11:15 A.M.

2nd SEMI FINAL  
11:15 A.M.

2nd SEMI FINAL  
11:15 A.M.

2nd SEMI FINAL  
11:15 A.M.

2nd SEMI FINAL  
11:15 A.M.

2nd SEMI FINAL  
11:15 A.M.

2nd SEMI FINAL  
11:15 A.M.

2nd SEMI FINAL  
11:15 A.M.

2nd SEMI FINAL  
11:15 A.M.

2nd SEMI FINAL  
11:15 A.M.

2nd SEMI FINAL  
11:15 A.M.

FINAL  
12:45 P.M.

FINAL  
12:45 P.M.

FINAL  
12:45 P.M.

FINAL  
12:45 P.M.

FINAL  
12:45 P.M.

FINAL  
12:45 P.M.

FINAL  
12:45 P.M.

FINAL  
12:45 P.M.

FINAL  
12:45 P.M.

FINAL  
12:45 P.M.

FINAL  
12:45 P.M.

FINAL  
12:45 P.M.

FINAL  
12:45 P.M.

FINAL  
12:45 P.M.

FINAL  
12:45 P.M.

FINAL  
12:45 P.M.

FINAL  
12:45 P.M.

FINAL  
12:45 P.M.

FINAL  
12:45 P.M.

FINAL  
12:45 P.M.

FINAL  
12:45 P.M.

FINAL  
12:45 P.M.

FINAL  
12:45 P.M.

FINAL  
12:45 P.M.

FINAL  
12:45 P.M.

FINAL  
12:45 P.M.

FINAL  
12:45 P.M.

FINAL  
12:45 P.M.



 THEEM COLLEGE OF ENGINEERING Bolisar, Dist. Palghat, Kerala	
<b>ATHLON 2K19 SCHEDULE</b>	
NAME OF EVENT	CRICKET
CO-ORDINATOR	PROF. AYAZ BAGWAN
SPORTS CO-ORDINATOR	PROF. PRASHANT RATHOD
DRAWING BY	MR. SYED KAZIM

  
 PRINCIPAL

THEEM COLLEGE OF ENGINEERING  
 1st Village Boregon, Bolisar Chhithal, Bolisar  
 Palghat (East) Tal. & Dist. Palghat - Kerala



# JASHN - E - THEEM 2019

(DATE: 14/01/2019 TO 19/01/2019)

OVER ALL COORDINATOR MR. AZIZ-UR-REHMAN SIR

Sr.No	Event	Chief Co-ordinators	Members
01	Prize Distribution	Prof.Tilottama Deore & Prof. Rahatullah Khan	1) Prof.Rosy Bhoi 2)Prof.Srikrishna Sonavane 3)Prof. Jayashree Sali 4) Prof Zulfiquar Ahmad 5) Prof.Ruchi Rahi 6) Mr.Sayyed Kazim Ali 7) Ms.Shweta Sankhe 8) Prof.Roshan Vani 9) Prof.Sarfaraz Shaikh
02	Sports	Prof.Prashant Rathod	Prof.Syed Tanzeem,Prof.Awani Sankhe,Prof.Vinod Dhande,Prof.Rakesh Kushwah,Prof.Rajesh Patil,Prof.Sarita Tiwari,Prof.Dadas Balaji,Prof.Tejal Raut,Prof.Krunal Pimple,Prof.Jyothi Kumari,Prof.Emily Ghosh,Prof.Vinay Sahu,Prof.Khalil Pinjari,Prof.Inayat Khan,Ms.Hemlata Jangale,Prof.Arsalan Khan,Prof.Iqbal Mansoori,Prof.A.Kumar,Prof.P ramod Maurya,Prof.Ashraf Siddique,Prof.Sanketi Raut,Prof.Harshal



			<p>Ahire, Prof. K.N. Attarde, Prof. Umar Jamadar, Ms. Oniza Shaikh, Mr. Roshan Vade, Ms. Sayali Pimple, Mr. Ravindra Dawane, Prof. Santosh Khorne, Prof. Ganesh Rodge, Prof. Emily Ghosh, Prof. Nitin Sall, Prof. Waseem Sultan, Ms. Sayali Mahajan, Prof. Faiz Shaikh, Prof. Rosy Bhoi, Prof. Abid Ansari, Mr. Atul Sankhe, Prof. Rajat Singh, Prof. Ruchi Rahi, Prof. Azar Nabi, Mr. Priyasan Thakur, Ms. Vaishali Patil, Prof. Nirajsingh Yeotikar, Prof. Vivek Anan, Prof. Ayaz Bagwan, Mr. Amol Patil, Mr. Kazim Ali, Mr. Sumit Mhatre.</p>
03	Cultural	<p>Prof. Ansar Shaikh  <i>Santa's Hmbaria</i>  <i>Geeta Yechar</i></p>	<p>Prof. Zulfiquar, Prof. Snehal Pawde, Prof. Arbia Shaikh, Prof. Geeta Yadur, Prof. Nitin Sall, Prof. Tasneem Azam, Ms. Surekha Attarde, Mr. Abusaeed.</p>
04	<p>Technical</p> 	<p>Prof. Elahi Shaikh  <i>Rajesh Bahil</i></p>	<p>Prof. Khemchandra Attarde, Prof. Nirajsingh Yeotikar, Prof. Furqan Hassan, Prof. Saleha Talaha, Hemlata Jangle, Surekha Attarde, Moin Ansari, Rajesh Patil, Sneha Sankhe, Pushkarini, Amjad ali, Khalil Pinjari, Ahamad</p>



			Shaikh, Manoj Gwada, Nitin Sall, Harshad Ranadive, Syed Tanzeem, Tasneem Azam, Faiz Mohd, Sudhi Reddy, Ketan Nikam, Mohatashim Azar, Waseem Sultan, Ashraf Siddiqui, Arsalan Shaikh, Ansari Abid, Shoeb Khan, Kalamuddin Ansari, Waseem Shah, Santosh Khorne, Naeem Jilani, Afjal Shaikh, N.M. Gulbarga, Amit Nimbalkar, Atul Sankhe, Harshal Patil, Nitin Sall, Tejal Raut, Irfan Pathan, Tasneem Azam, Sarfaraj shaikh, Mohitesham Azar. Khan Wasim Sultan, Sanketi Raut, Nisar shah, Firoj Pathan, Oniza Shaikh.
05	Magazine	Prof. Balasubramani	Dr. Amritanshu Kumar, Mr. Rashikh Shaikh, Azhar Nabi, Prof. Srikrishna Sonawane, Prof. Geetha Yadur
06	Finance	Prof. Raees Ahmad	Prof. Khalil Pinjari, Ashraf Shah, Vijay Ghanokar, Rajesh Patil, Nirajsingh Yeotikar, Vinod Dhande, Ruchi Rahi.
07	Discipline	Prof. Saleem Pasha Chaudhary	Sayyad Layak B., Zulfiquar, Wasim Khan, Harshal Patil, Khemchandra Attarde, Gulbarga sir, Elahi Shaikh, Ayaz Bagwan, Pramod Maurya, Prashant Rathod, Khalil Pinjari, Ambuj Tiwari, Sneha Sankhe, Awani Sankhe, Umar jamadar, Mr. Roshan Wade, Mr. Ravindra Dawane, Mr. Atul





			Sankhe, Mr. Anis Ahmad, Mr. Sandesh Patil, Mr. Rupesh Sankhe, Ms. Sheetal Patil, Ms. Hemlata Jangale.
--	--	--	---

  
**(DR.N.K.RANA)**  
**DIRECTOR**



  
**PRINCIPAL**  
THE FEAT COLLEGE OF ENGINEERING  
No. Village Birigaoan, Borisar Chittr 2  
Dist. East Tal. & Dist. Palghar

5.2.4 Sports and cultural activities / competitions organized at the institution level during the year. (5)

Year		Activity	Level	Participants
2018-19	Cultural	Dance Group	Institution level	3
		Dance Solo	Institution level	16
		Mehndi	Institution level	12
		Rangoli	Institution level	12
		Floral Decoration	Institution level	9
		Best out of Waste	Institution level	11
		Singing Solo	Institution level	9
		Poster Painting	Institution level	8
		<b>Total</b>		<b>80</b>
	Sports Intra	Cricket	Institution level	28
		Volleyball	Institution level	10
		Football	Institution level	9
		Kabaddi	Institution level	9
		Kho-Kho	Institution level	6
		Box cricket	Institution level	28
		Neon cricket	Institution level	10
		Chess	Institution level	30
		Girls Throw ball	Institution level	3
		Running(100m)	Institution level	30
		Running(200m)	Institution level	25
		Relay(100*4)	Institution level	30
		Javelin	Institution level	20
		Shotput	Institution level	20
		Disc throw	Institution level	20
		Carrom	Institution level	20
		Blind fold	Institution level	35
		Badminton	Institution level	35
		Tug of War	Institution level	10
	<b>Total</b>		<b>378</b>	
	Competitions Junior Scientist	Primary	Institution level	24
Secondary		Institution level		
Higher secondary		Institution level		
<b>Total Event-(30)</b>				



*[Handwritten Signature]*

PRINCIPAL  
THEEM COLLEGE OF ENGINEERING  
At Village Bolegaon, Boisar Chikhar Tal.  
Boisar (East) Tal. & Dist. Palghar







Success... through  
quality education !

H. J. Thim Trust's

# Theem College of Engineering

Approved by AICTE (New Delhi), Government of Maharashtra and DTE  
Affiliated to University of Mumbai

Village Betegaon, Boisar Chihar Road, Boisar (E), Tal. & Dist. Palghar - 401 501.

Tel.: (02525) 284 909 ● Telefax : (02525) 284 927 ● Email : info@theemcoe.org ● Website : www.theemcoe.org

Ref. No.: TCE/ES/2018-19/408  
To,

Date: 05/01/2019

**Shri. Gaurav Singh, IPS**  
Superintendent of Police  
Palghar District  
Palghar - 401404

**Subject:** Request to be Chief Guest for opening of our Annual Functions "JASHN-E-THEEM" on 16<sup>th</sup> Jan. '2019 at 10.00 a.m.

Honorable Sir,

Theem College of Engineering is a premier Engineering Institute of H.J. Thim Trust at Boisar, Taluka & District Palghar, conducting Graduate Engineering Program in Computer Engg., I.T. Engg., Elec. & Telecomm. Engg, Electrical Engg. Mechanical Engg, Civil Engg and Automobile Engg. We also offer Diploma Engg. Programme in Computer Engg. Mech.Engg. and Civil Engg.

Theem College of Engineering is organizing Annual College function in Sports, Cultural and Technical activities from 16<sup>th</sup> Jan. to 19<sup>th</sup> Jan., 2019

The Principal, Staff, Students and Management of this Institute will be obliged and grateful for the opening of the Annual College Function with your auspicious hands to be held on 16<sup>th</sup> January '2019 at 10.00 a.m. The Annual College Function, which includes Sports, Cultural and Technical activities, will be held for a week.

We will be honoured for your kind consent of accepting our invitation.

Thanking you,

Yours faithfully,



PRINCIPAL  
THEEM COLLEGE OF ENGINEERING  
St. Village Betegaon, Boisar Chihar R.  
Palghar (East) Tal. & Dist. Palghar

(Dr. N.K. Rana)

Director



Success... through  
quality education!

H. J. Thim Trust's

# Theem College of Engineering

Approved by AICTE (New Delhi), Government of Maharashtra and DTE  
Affiliated to University of Mumbai

Village Belegaon, Boisar Chilhar Road, Boisar (E), Tal. & Dist. Palghar - 401 501.

Tel.: (02525) 284 909 ● Telefax : (02525) 284 927 ● Email : info@theemcoe.org ● Website : www.theemcoe.org

Date: 05/01/2019

Ref. No. TCE/ES/2018-19/408

To,

**Shri. Gaurav Singh, IPS**  
Superintendent of Police  
Palghar District  
Palghar - 401404

**Subject:** Request to be Chief Guest for opening of our Annual Functions "JASHN-E-THEEM" on 16<sup>th</sup> Jan. '2019 at 10.00 a.m.

Honorable Sir,

Theem College of Engineering is a premier Engineering Institute of H.J. Thim Trust at Boisar, Taluka & District Palghar, conducting Graduate Engineering Program in Computer Engg., I.T. Engg., Elec. & Telecomm. Engg, Electrical Engg, Mechanical Engg, Civil Engg and Automobile Engg. We also offer Diploma Engg. Programme in Computer Engg, Mech.Engg. and Civil Engg.

Theem College of Engineering is organizing Annual College function in Sports, Cultural and Technical activities from 16<sup>th</sup> Jan. to 19<sup>th</sup> Jan., 2019

The Principal, Staff, Students and Management of this Institute will be obliged and grateful for the opening of the Annual College Function with your auspicious hands to be held on 16<sup>th</sup> January '2019 at 10.00 a.m. The Annual College Function, which includes Sports, Cultural and Technical activities, will be held for a week.

We will be honoured for your kind consent of accepting our invitation.  
Thanking you,

Yours faithfully,



PRINCIPAL  
THEEM COLLEGE OF ENGINEERING  
St. Village Belegaon, Boisar Chilhar Road,  
Boisar (E), Tal. & Dist. Palghar - 401 501

(Dr. N.K. Rana)  
Director

Admn. Office : 310, Yusuf Building, Veer Nariman Road, Fort, Mumbai - 400 023.  
Tel : 2204 8903 ● Telefax : 2203 9950



Success... through  
quality education

# Theem College of Engineering

Village Botegaon, Boisar Chilhar Road, Boisar (E), Tal. & Dist. Palghar - 401 501

Tel: (02525) 284 909 • Telefax: (02525) 284 927 • Email: info@theemcoe.org • Website: www.theemcoe.org

Ref NO-TCE/EST/2018-19/426

Ref:

Date: 12/01/2019

To  
Dr. Suhas Pednekar  
Vice Chancellor  
University of Mumbai  
Fort, Mumbai.

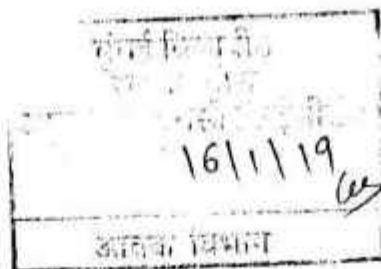

**Subject:** Request for your kind words for our Annual Magazine Theem Mirror 2019

Honorable Sir,

Theem College of Engineering publishes its Annual Magazine Theem Mirror and your presence in this issue through your words forwarded to Editorial Board for this occasion will boost the confidence of our students.

The Management, Principal, Staff and Students of this Institute shall remain obliged and grateful for your kind words and contribution in Theem Mirror 2019.

We sincerely request you to contribute for this year's Theem Mirror 2019 and hope to have your favourable response in this regards.

Thanking you

Yours faithfully

(Dr. N.K. Rana)  
Director

PRINCIPAL  
THEEM COLLEGE OF ENGINEERING  
Boisar (East), Tal. & Dist. Palghar-401 501.



PRINCIPAL  
THEEM COLLEGE OF ENGINEERING  
Village Botegaon, Boisar Chilhar Road,  
Boisar (East), Tal. & Dist. Palghar - 401 501





# Theem College of Engineering

Village Belgaon, Boisar Chitihar Road, Boisar (E), Tal. & Dist. Palghar - 401 501

Tel : (02525) 284 909 ● Telefax : (02525) 284 927 ● Email : info@theemcoe.org ● Website : www.theemcoe.org

Ref No TCE/EST/2018-19/428

Ref:

Date: 12/01/2019

To  
Dr. Abhay Wagh  
Director  
DTE, Mahapalika Marg  
Mumbai.

**Subject:** Request for your kind words for our Annual Magazine Theem Mirror 2019

Honorable Sir,

Theem College of Engineering publishes its Annual Magazine Theem Mirror and your presence in this issue through your words forwarded to Editorial Board for this occasion will boost the confidence of our students.

The Management, Principal, Staff and Students of this Institute shall remain obliged and grateful for your kind words and contribution in Theem Mirror 2019.

We sincerely request you to contribute for this year's Theem Mirror 2019 and hope to have your favourable response in this regards.

Thanking you

Yours faithfully

(Dr. N.K. Rana)

Director  
PRINCIPAL

THEEM COLLEGE OF ENGINEERING  
Boisar (East), Tal. & Dist. Palghar-401 501



PRINCIPAL  
THEEM COLLEGE OF ENGINEERING  
St. Village Belgaon, Boisar Chitihar R.  
Boisar (East) Tal. & Dist. Palghar - 401 501

9/1/19

DR. N. K. RANA

9/1/19



Success... through  
quality education

# Theem College of Engineering

Village Betegaon, Boisar Chilhar Road, Boisar (E), Tal. & Dist. Palghar - 401 501

Tel. (02525) 284 909 • Telefax : (02525) 284 927 • Email : info@theemcoe.org • Website : www.theemcoe.org

Ref No TCE/EST/2018-19/427

Date: 12/01/2019

Ref:

To

Dr. Vinod Mohitkar  
Director  
MSBTE  
Bandra, Mumbai.

**Subject:** Request for your kind words for our Annual Magazine Theem Mirror 2019

Honorable Sir,

Theem College of Engineering publishes its Annual Magazine Theem Mirror and your presence in this issue through your words forwarded to Editorial Board for this occasion will boost the confidence of our students.

The Management, Principal, Staff and Students of this Institute shall remain obliged and grateful for your kind words and contribution in Theem Mirror 2019.

We sincerely request you to contribute for this year's Theem Mirror 2019 and hope to have your favourable response in this regards.

Thanking you

Yours faithfully

(Dr. N.K. Rana)  
PRINCIPAL  
PRINCIPAL

THEEM COLLEGE OF ENGINEERING  
Boisar (E) Tal. & Dist. Palghar-401 501



PRINCIPAL  
THEEM COLLEGE OF ENGINEERING  
At Village Betegaon, Boisar Chilhar Road,  
Palghar (E) Tal. & Dist. Palghar

लिपिक  
नोंदणी विभाग (का.क्र. २२)  
म.रा.तं.शि.मं. मुंबई-५९

16 JAN 2019

Head Office : 310, Yusuf Building, Veer Nariman Road, Fort, Mumbai - 400 023.  
Tel.: 2204 6903 • Telefax : 2283 9850



Success... through  
quality education

# Theem College of Engineering

Village Betegaon, Boisar Chilhar Road, Boisar (E), Tal. & Dist. Palghar - 401 501

Tel: (02525) 284 909 ● Telefax: (02525) 284 927 ● Email: info@theemcoe.org ● Website: www.theemcoe.org

Ref No TCE/EST/2018-19/427

Date: 12/01/2019

Ref:

To

Dr. Vinod Mohitkar

Director

MSBTE

Bandra, Mumbai.

**Subject:** Request for your kind words for our Annual Magazine Theem Mirror 2019

Honorable Sir,

Theem College of Engineering publishes its Annual Magazine Theem Mirror and your presence in this issue through your words forwarded to Editorial Board for this occasion will boost the confidence of our students.

The Management, Principal, Staff and Students of this Institute shall remain obliged and grateful for your kind words and contribution in Theem Mirror 2019.

We sincerely request you to contribute for this year's Theem Mirror 2019 and hope to have your favourable response in this regards.

Thanking you

Yours faithfully

(Dr. N.K. Rana)

PRINCIPAL

PRINCIPAL

THEEM COLLEGE OF ENGINEERING

Boisar (Est.) Tal. & Dist. Palghar-401 501



PRINCIPAL

THEEM COLLEGE OF ENGINEERING

M. Village Betegaon, Boisar Chilhar Road,

Boisar (Est.) Tal. & Dist. Palghar - 401 501



Ref: (R.O. Tce/Est) 2018-19) 427

Date: 12/01/2019

To  
Dr. Vinod Mohitkar  
Director  
MSBTE  
Bandra, Mumbai.

Subject: Request for your kind words for our Annual Magazine Theem Mirror 2019

Honorable Sir,

Theem College of Engineering publishes its Annual Magazine Theem Mirror 2019 and your presence in this issue through your words forwarded to Editorial Board for this occasion will boost the confidence of our students.

The Management, ~~the~~ Principal, ~~the~~ Staff and Students of this Institute shall remain obliged and grateful for your kind words and contribution in Theem Mirror 2019.

We sincerely request you to contribute for this year's Theem Mirror 2019 and hope to have your favourable response in this regards.

Thanking you

Yours faithfully



(Dr. N.K. Rana)  
PRINCIPAL



PRINCIPAL  
THEEM COLLEGE OF ENGINEERING  
Village Belegaon, Borisar Chikhar Road  
Near East. Tel. & Dist. Police

Ref: 107/CE/EST/2018.19/428

Date: 12/01/2019

To  
Dr. Abhay Wagh  
Director  
DTE, Mahapalika Marg  
Mumbai.

Subject: Request for your kind words for our Annual Magazine Theem Mirror 2019

Honorable Sir,

Theem College of Engineering publishes its Annual Magazine Theem Mirror 2019 and your presence in this issue through your words forwarded to Editorial Board for this occasion will boost the confidence of our students.

The Management, the Principal, the Staff and Students of this Institute shall remain obliged and grateful for your kind words and contribution in Theem Mirror 2019.

We sincerely request you to contribute for this year's Theem Mirror 2019 and hope to have your favourable response in this regards.

Thanking you

Yours faithfully

  
(Dr. N.K. Rana)  
Director





PRINCIPAL  
THEEM COLLEGE OF ENGINEERING  
Village Betegaon, Boisar Chitambar Road  
Boisar (East) Tal. & Dist. Palghar

Ref: No. Tce/Est/2018-19/426

Date: 12/01/2019

To  
Dr. Suhas Pednekar  
Vice Chancellor  
University of Mumbai  
Fort, Mumbai.

Subject: Request for your kind words for our Annual Magazine Them Mirror 2019

Honorable Sir,

Theem College of Engineering publishes its Annual Magazine Them Mirror ~~2019~~ and your presence in this issue through your words forwarded to Editorial Board for this occasion will boost the confidence of our students.

The Management, ~~the~~ Principal, ~~the~~ Staff and Students of this Institute shall remain obliged and grateful for your kind words and contribution in Them Mirror 2019.

We sincerely request you to contribute for this year's Them Mirror 2019 and hope to have your favourable response in this regards.

Thanking you

Yours faithfully



(Dr. N.K. Rana)  
Director



PRINCIPAL  
THEEM COLLEGE OF ENGINEERING  
No. Village Belegaoi, Boisar Chitli Road  
Boisar (East) Tal. & Dist. Palghar - 407 502



Ref No - TCE/EST/2018-19/407

Date - 04/01/2019.

To,

**Dr. Abhay Wagh**

Director of Technical Education, Maharashtra State

3, Mahapalika Marg, Post Box No.1967

Opp.Metro Cinema, Mumbai - 400001

**Subject:** Request to be Chief Guest for Valedictory of our Annual Functions "JASHN-E-THEEM" on 19<sup>th</sup> Jan. '2019 at 04.00 p.m.

Honorable Sir,

Theem College of Engineering is a premier Engineering Institute of H.J. Thim Trust at Boisar, Taluka & District Palghar, conducting Graduate Engineering Program in Computer Engg., I.T. Engg., Elec. & Telecomm. Engg, Electrical Engg. Mechanical Engg, Civil Engg and Automobile Engg. We also offer Diploma Engg. Programme in Computer Engg. Mech.Engg. and Civil Engg.

← Theem College of Engineering is organizing Annual College function in Sports, Cultural and Technical activities from 16<sup>th</sup> Jan. to 19<sup>th</sup> Jan., 2019

The Principal, Staff, Students and Management of this Institute shall be obliged and grateful with your gracious presence on 19<sup>th</sup> January 2019 at 4.00 p.m. on the occasion of valedictory function of our Annual Function.

We will be honoured for your kind consent of accepting our invitation.  
Thanking you,

Yours faithfully,



PRINCIPAL  
THEEM COLLEGE OF ENGINEERING  
C/o. Village Bolegaon, Boisar Chitambar  
Boisar (East) Tal. & Dist. Palghar



(Dr. N.K. Rana)  
Director



Success... through  
quality education!

H. J. Thim Trust's

# Theem College of Engineering

Approved by AICTE (New Delhi), Government of Maharashtra and DTE  
Affiliated to University of Mumbai

Village Betegaon, Boisar Chilhar Road, Boisar (E), Tal. & Dist. Palghar - 401 501.

Tel.: (02525) 284 909 ● Telefax : (02525) 284 927 ● Email : info@theemcoe.org ● Website : www.theemcoe.org

Ref No - TCE/EST/2018-19/407.

Date - 04/01/2019

To,

**Dr. Abhay Wagh**

Director of Technical Education, Maharashtra State

3, Mahapalika Marg, Post Box No.1967

Opp.Metro Cinema, Mumbai - 400001

**Subject:** Request to be Chief Guest for Valedictory of our Annual Functions "JASHN-E-THEEM" on 19<sup>th</sup> Jan. '2019 at 04.00 p.m.

Honorable Sir,

Theem College of Engineering is a premier Engineering Institute of H.J. Thim Trust at Boisar, Taluka & District Palghar, conducting Graduate Engineering Program in Computer Engg., I.T. Engg., Elec. & Telecomm. Engg, Electrical Engg, Mechanical Engg, Civil Engg and Automobile Engg. We also offer Diploma Engg. Programme in Computer Engg. Mech.Engg. and Civil Engg.

Theem College of Engineering is organizing Annual College function in Sports, Cultural and Technical activities from 16<sup>th</sup> Jan. to 19<sup>th</sup> Jan., 2019

The Principal, Staff, Students and Management of this Institute shall be obliged and grateful with your gracious presence on 19<sup>th</sup> January 2019 at 4.00 p.m. on the occasion of valedictory function of our Annual Function.

We will be honoured for your kind consent of accepting our invitation.

Thanking you,

Yours faithfully,



PRINCIPAL  
THEEM COLLEGE OF ENGINEERING  
Village Betegaon, Boisar Chilhar Road,  
Boisar (E) Tal. & Dist. Palghar - 401 501

(Dr. N.K. Rana)

Director

Intra Sports Event						
	No of Players	Trophy	BEST BATS/WAN			Certificates
			Man of the match	Man Of The Series	Best Bowler	
Cricket(Boys)	16	2	1	1	1	35
Cricket(Girls)	16	2	1	1	1	35
Cricket (Boys Box)	9	2	1	1	1	30
Cricket (Girls Box)	9	2	1	1	1	20
NEON CRICKET(BOYS)	7	2				14
NEON CRICKET(Girls)	7	2				14
Total		12	4	4	4	138
Football	16	2	Best Goaler	1		Certificates 30
Valley Ball (Boys)	12	2	Best Smasher	1		25
Throw Ball (Girls)	10	2	Best Thrower	1		22
Kabaddi(Boys)	12	2	Best Raider	1		25
Kabaddi(Girls)	12	2		1		25
KHO KHO(Boys)	12	2	Best Raider	1		25
KHO KHO(Girls)	12	2		1		25
Tug Of War	8	2				16

16 = 28

Total 334

Athletic Event					
	Gold	Silver	Bronze		Certificate
Chess	2	2	2		6
Running(100m)	2	2	2		6
Running(200m)	2	2	2		6
Relay(100*4)	8	8	8		24
Javelin	2	2	2		6
Shot Put	2	2	2		6
Disc Throw	2	2	2		6
Carrom	6	6	2		6
Blind Fold	4	4			12
Badminton	6	6			10
	35	35	20	Total	92

INTER EVENT						
	No of Players	Trophy	BEST BATS/WAN			Certificates
			Man-of-the-match	Man Of The Series	Best Bowler	
Cricket	16	2	1	1	1	35
Valleyball	12	2				25
Football	16	2				30
Box Cricket	9	2				19
Neon Cricket	7	2				14
KABADDI						Total 126

Total No Of Certificate	552
No of Trophies(Intra)	45
No of Trophies(Inter)	13
Total No Of Trophies	58

Event	Cash Price
Cricket	5000
Valleyball	3000
Football	5000
Box Cricket	3000
Neon Cricket	1000

Medals	
Gold	35
Silver	35
Bronze	20

T-Shirts  
 Team Event — 50 nos. [15 + 15 + 10] ✓  
 Staff — 175 nos. ✓



PRINCIPAL  
 THEEM COLLEGE OF ENGINEERING  
 Village Boigason, Boiser, Chhatisgarh  
 Dist. Palham



H. J. Thim Trust's  
**Theem College of Engineering, Boisar**  
 Approved by AICTE (New Delhi), Government of Maharashtra and DTE  
 Affiliated to University of Mumbai

**Jashn-E-Theem 2K19**

Sr.	EVENTS	CERTIFICATES			TROPHY	INDIVIDUAL/ GROUP MEMBERS
		Winner Cert.	Part. Cert.	Medals G+S+BR		
1	Traditional + Rose day	2+2+2	----	2+2+2	----	1 + 1
2	Retro+Chocolate day	2+2+2	----	2+2+2	----	1 + 1
3	Mismatch Day	2+2+2	----	2+2+2	----	1 + 1
4	Saree/Formal day	2+2+2	----	2+2+2	----	1 + 1
5	Dance Group	7+7+7	10	7+7+7	3(W+R1+R2)	7
6	Dance Solo	1+1+1	5	----	3(W+R1+R2)	1
7	Mimicry	1+1+1	----	----	3(W+R1+R2)	1
8	Mehndi	1+1+1	----	----	3(W+R1+R2)	1
9	Rangoli	1+1+1	----	----	3(W+R1+R2)	1
10	Floral Decoration	1+1+1	----	----	3(W+R1+R2)	1
11	Best out of Waste	3+3+3	----	3+3+3	3(W+R1+R2)	3
13	Singing Solo	1+1+1	7	----	3(W+R1+R2)	1
14	Poster Painting	1+1+1	----	----	3(W+R1+R2)	1
<b>Total</b>		69	22	45	(9W+9R1+9R2)	
		<b>91</b>		SA		

Note: It is probable list, may change based on the number of entries in the event.

<i>Ahmad Shaikh</i> Cultural Coordinator	<i>Ahmad Shaikh</i> Principal
Ansa Ahemad Shaikh	Dr. Aqueel Shah

Medals #45  
Trophies #27

10/01/19



*Ahmad Shaikh*  
**PRINCIPAL**  
 THEEM COLLEGE OF ENGINEERING  
 At Village Belegaon, Boisar Taluka, Dist. Palghar

## SPORTS STORE STCK & ADDITIONAL REQUIRMENTS 2019

SR NO	Items	Available Quantities in Stock	Required
1	Cricket stumps	13 Nos	3 NOS
2	Cricket bat	7 Nos	3 NOS
3	Tennis ball (heavy) headly	8 Box	10 Ball
4	Tennis ball (light) TENNEX	1 Box	NIL
5	Bails	8 Nos	NIL
6	Grips	9 Nos	2
7	Guard	4 Nos	NIL
8	Foot Ball	2 Nos	6
9	Foot Ball Net	4 Nos	NIL
10	Volley Ball	3 Nos	NIL
11	Volley Ball Net	1 Nos	NIL
12	Throw Ball	5 Nos	NIL
13	Badminton Rackets	8 Nos	2
14	Badminton Net	2 Nos	NIL
15	Shuttle Cock	1 Box	2 BOX
16	Carom stand	6 Nos	NIL
17	Carom board	5 Nos	NIL
18	Stricker	8 Nos	NIL
19	Coins	7 Box	NIL
20	Carom Powder	NIL	6 Packets
21	Disc	2 Nos	NIL
22	Shot Put	2 Nos	NIL
23	Javellin	2 Nos	NIL
24	Tug Of war Rope	1 Nos	NIL
25	Jumming Rope	12 Nos	NIL
26	Chess Board	4 Nos+10 Nos	NIL
27	Relay Batten	6 Nos	6
28	Go Clap	2 Nos	NIL
29	Weighing Machine	1 Nos	NIL
30	Measuring tape	3 Nos	NIL
31	Air Pump	4 Nos	Repair
32	Stop Watch	4 Nos	Repair
33	Whistle	NIL	30
34	Marking Rope	1 Nos	300M bundle
35	Mashal	1 Nos	NIL
36	Smily Ball	9 Nos	12 Nos
37	Radium Paper (Night Glow)	NIL	12 sq ft
38	Black Scrap paper	NIL	30 Nos
39	Radium LED Torch	1 Nos	NIL
40	Air Freshner	NIL	6 Nos
41	Marking Powder	NIL	12 bags(20kg)
42	Umpire Round cap	10 NOS	20 Nos
43	Score Book	NIL	12 Nos

*X.P. Patil*

  
**PRINCIPAL**  
 THEEM COLLEGE OF ENGINEERING  
 Village Behgaon, Bomer Chattr, 2-  
 Near (East) Tal. & Dist. Polhwar





### Intra Sports Event

BEST BATSMAN						
	No of Players	Trophy	Man of the match	Man-Of-The-Series	Best Bowler	Certificates
Cricket(Boys)	16	2	2	1	1	35
Cricket(Girls)	16	2	2	1	1	35
Cricket (Boys-Box)	9	2	2	1		20
Cricket (Girls-Box)	9	2	2	1		20
NEON CRICKET(BOYS)	7	2	2			14
NEON CRICKET(Girls)	7	2	2			14
<b>Total</b>			12	4	2	138
			Best Goaler			Certificates
Football	16	2	2	1		33
			Best Smasher			
Valley Ball	12	2	2	1		25
			Best Thrower			
Throw Ball	10	2	2	1		22
			Best Raider			
Kabaddi(Boys)	12	2	2	1		25
Kabaddi(girls)	12	2	2	1		25
			Best Raider			
KHO KHO(Boys)	12	2	2	1		25
KHO KHO(Girls)	12	2	2	1		25
<b>Total</b>			8	2		16
Tug Of War	8	2	2			
<b>Total</b>						334

### Athletic Event

	Gold	Silver	Bronze	Certificate
Chess	2	2	2	6
Running(100m)	2	2	2	6
Running(200m)	2	2	2	6
Relay(100*4)	8	8	8	24
Javelin	2	2	2	6
Shot Put	2	2	2	6
Disc Throw	2	2	2	12
Carrom	6	6		10
Blind Fold	4	4		10
Badminton	5	5		
<b>Total</b>	35	35	20	92

### INTER EVENT

	No of Players	Trophy	Man of the match	Man Of The Series	Best Bowler	Certificates
Cricket	16	2	2	1	1	35
Valleyball	12	2	2		1	25
Football	16	2	2		1	33
Box Cricket	9	2	2			19
Neon Cricket	7	2	2			14
<b>Total</b>						126

Total No Of Certificate	552
No of Trophies(Intra)	45
No of Trophies(Inter)	13
Total No Of Trophies	58

Medals	
Gold	35
Silver	35
Bronze	20

Event	Cash Prize
Cricket	5000
Valleyball	3000
Football	5000
Box Cricket	3000
Neon Cricket	1000
Refree (Foot Ball)	2000
Refree Volley ball	1000

  
**PRINCIPAL**  
 THEEM COLLEGE OF ENGINEERING  
 At Village Boragan, Bolar Chikri, P.  
 Bosar (East) Tal. & Dist. Palghar

Grand Total  
 = 20000/-

*APART*





Name Of Event		Co-ordinator Name					
<b>Outdoor Games</b>							
1	Cricket (Girls)	Awani Sankhe	Sanketi Raut	Sayali Mahajan			
2	Cricket	Ayaz bagwan	Harshal Ahire	Ansar Shaikh	Priyasan Thakur	Krunal Pimple	Vinod Dhande
3	Cricket(BOX)	Rakesh Khuswa	Abid Ansari	Ahmed Shaikh	Sumit Mhatre		
4	FootBall	Syed Tanzeem	Khalil Pinjari	Faiz Shaikh	Raes Ahmed	Vivek Anand	Kazim
5	ValleyBall	Rajesh Patil	K N Attarde	Imran Khan	IQBAL MANSUR	Manoj Gowda	Amol Patil
6	ThrowBall(Girls)	Tasneem	Hemlata	Sayali Patil	Vaishali Patil	Sureka Attarde	
7	Kabaddi(Girls)	Sarita Tiwari	Hemlata jangale	Rosy Bhoi	Ruchi Rahi		
8	Kabaddi	X Umar Jamadar	Balaji Dadas	Abid Sir	Chansdan Khadse		
9	Kho Kho(Girls)	Tejal Raut	Oniza Shaikh	Surekha Attarde			
10	Kho Kho	Krunal Pimple	Roshan Wade	Atul Sankhe			
11	Badminton	Jyothi Kumari	Sayali Pimple	Rajat Siggh	Niraj Singh		
12	Tug Of War	Tejas Thakur	Ravi Dhavne	Vinay Sahu			
13	Blind Fold & Blind HitMan	Khalil Pinjari	Santosh Khorne				
<b>Athletics Event</b>							
1	100M(Boys)+200M	Prof.Inayat Khan	Prof.Ganesh Rodge	Shubham Bhandari			
2	100M(Girls)	Hemata Jangale	Surekha Attarde	Ruchi Rahi	Oniza Shaikh		
3	Relay	Arsalan KHAN					
4	Javelin	Ansar Shaikh					
5	Disc Throw	IRFAN KHAN					
6	Short Put	IQBAL MANSURI					
<b>Indoor Games</b>							
22	Chess	Emily Ghosh	Wasim Sultan	Ganesh Sir			
23	Carrom	Promod Mourya	Nitin Sall				
24	Neon Cricket	Ashraf Sidiqui	Waseem Sultan	Azhar Nabi	Vivek Anand		

*Handwritten signature/initials*



*Handwritten signature of the Principal*

**PRINCIPAL**

**THEEM COLLEGE OF ENGINEERING**  
 At. Village Betegaon, Bolsar Chithar Road,  
 Palisar (East) Tal. & Dist. Palahar.

H.J.THIM TRUST'S  
Theem College of Engineering  
PROMETHEAN' 19



*Final*

Sr.	EVENTS	INTER COLLEGE/ INTRA COLLEGE	CERTIFICATES			TROPHY	INDIVIDUAL GROUP MEMBERS
			Winner Certificates	Participation Certificate	Medals G+S+BR		
1	Inauguration (RAW)	INTRA	0	20	0	0	0
2	Robo Race *	INTRA/INTER	12+12	30	4+4+4	0	4
	Mini Militia	INTRA	12	15	4+4+4	0	4
3	Technical Presentation	INTRA	9	20	3+3+3	1W+1R1+1R2	3
4	Junior Scientist	INTER	18	100	9+9	3 winners + 3 1st runner	3
5	P.C Assembly	INTRA	6	0	2+2+2	0	2
6	Blind Programming	INTRA	3	0	1+1+1	0	1
7	Web Design	INTRA	3	0	1+1+1	0	1
8	Angry Bird	INTRA	0	0	0	0	1
9	Aqua booster	INTRA	12	0	4+4+4	0	4
10	Power Tower	INTRA	15	0	5+5+5	0	5
11	Bridge Making	INTRA	12	0	4+4+4	0	4
12	Town Planning	INTRA	6	0	2+2+2	0	2
13	AutoCAD	INTRA	3	0	1+1+1	0	1
14	Lan Gaming	INTRA	10	0	5+5	0	4
15	Sudoku	INTRA	2	0	1+1	0	1
16	PUBG	INTRA	21	0	7+7+7	0	4,2,1
17	Make it 3D	INTRA	6	0	2+2+2	0	2
18	Computer Quiz	INTRA	6	0	2+2+2	0	2
19	Programming Challenge	INTRA	3	0	1+1+1	0	1
20	Code Breaker	INTRA	3	0	1+1+1	0	1
21	Boat Challenge	INTRA	12	0	4+4+4	0	4



PRINCIPAL  
THEEM COLLEGE OF ENGINEERING  
At. Village Betegaon, Bosisar Chikhar Road  
Bosisar (East) Tal. & Dist. Palahar - 387 001

22	Technical Quiz	INTRA	3	0	1+1+1	0	1
23	Pro biking	INTRA	3	0	1+1+1	0	1
24	Auto Quiz	INTRA	3	0	1+1+1	0	1
25	Creative Writing	INTRA	3	0	1+1+1	0	1
26	Rubik's Cube	INTRA	3	0	1+1+1	0	1
<b>Total</b>			<b>188</b>	<b>200</b>	<b>69+69+54</b>	<b>4(w)+4(R1)+ 1(R2)</b>	
			<b>388</b>				

PRINCIPAL  
Dr. N.K.Rana

  
TECHNICAL IN-CHARGE  
Prof. Elahi Shaikh



  
PRINCIPAL  
THEEM COLLEGE OF ENGINEERING  
At Village Betegaon, Botsar Chilhara Road,  
Botsar (East) Tal. & Dist. Palohar - 471 001



H.J.THIM TRUST's  
Theem College of Engineering  
PROMETHEAN' 19

Proposed 701

Sr.	EVENTS	INTER COLLEGE/ INTRA COLLEGE	CERTIFICATES			CASH PRIZE	TROPHY	INDIVIDUAL GROUP MEMBERS
			Winner Certificates	Participation Certificate	Medals G+S+BR			
1	Inauguration (RAW)		0	20	0	0	0	0
2	Robo Race	INTRA/INTER	12+12	40	4+4+4	2500+1500+1000	0	4
	Robo War	INTER	12	15	0	2500+1500+1000	0	4
	Robo Soccer	INTRA	8	15	4+4	0	0	4
*3	Technical Presentation	INTER	9	21	0	3	3(W+R1+R2)	3
*4	Junior Scientist	INTER	18	100	9+9	0	3 winners + 3 1st runner	3
5	P.C Assembly	INTRA	6	0	2+2+2	0	0	2
6	Blind Programming	INTRA	3	0	1+1+1	0	0	1
7	Web Design	INTRA	3	0	1+1+1	0	0	1
8	Angry Bird	INTRA	0	0	0	0	0	1
9	Aqua booster	INTRA/INTER	12+12	0	4+4+4	1000+500+250	0	4
10	Power Tower	INTRA	15	0	5+5+5	0	0	5
11	Bridge Making	INTRA	12	0	4+4+4	0	0	4
12	Town Planning	INTRA	6	0	2+2+2	0	0	2
13	AutoCAD	INTRA	3	0	1+1+1	0	0	1
14	Lan Gaming	INTRA	10	0	5+5	0	0	4
15	Sudoku	INTRA	2	0	1+1	0	0	1
16	Make it 3D	INTRA	6	0	2	0	0	2

*[Handwritten signature]*

PRINCIPAL  
THEEM COLLEGE OF ENGINEERING  
At. Village Betegaon, Bolar Chihhar Road,  
Bolar (East) Tal. & Dist. Palohar - 82



17	Programming Quiz	INTRA	6	0	2+2+2	0	0	2
13	Programming Challenge	INTRA	3	0	1+1+1	0	0	1
19	Code Breaker	INTRA	3	0	1+1+1	0	0	1
20	Boat Making	INTRA	12	0	4+4+4	0	0	4
21	Technical Quiz	INTRA	3	0	1+1+1	0	0	1
22	Pro biking	INTRA	3	0	1+1+1	0	0	1
23	Auto Quiz	INTRA	3	0	1+1+1	0	0	1
24	Creative Writing	INTRA	3	0	1+1+1	0	0	1
25	Aerodynamics Design & Flying Competition	INTRA	3	7	1+1+1	0	0	1
<b>Total</b>			<b>200</b>	<b>218</b>	<b>58+58+39</b>	<b>11750</b>	<b>4(w)+4(R1)+1(R2)</b>	
			<b>418</b>					

  
 PRINCIPAL  
 Dr. N.K. Rana

for. ~~Signature~~ (Surkha Attarde)  
 TECHNICAL IN-CHARGE  
 Prof. K.N. Attarde



  
 PRINCIPAL  
 THEEM COLLEGE OF ENGINEERING  
 At. Village Betegaon, Borsar Chiltar B...  
 Borsar (East) Tal. & Dist. Palohar...

H. J. Thim Trust's  
**Theem College of Engineering, Boisar**  
 Approved by AICTE (New Delhi), Government of Maharashtra and DTE  
 Affiliated to University of Mumbai

**Jashn-E-Theem 2K19**

Sr. No	Events Name	Staff Coordinator	Staff Coordinator Mobile Number	Student Coordinator	Student Coordinator Mobile Number	Schedule		
						Date	Time	Venue
1	Dance (competition)	Prof. Faiz Khan (Coordinator)	9175306697			17 and 18/01/2019	Evening	Main Stage
		Prof. Snehal Pawde (Co-coordinator)	8149585212					
		Prof. Priyanka Dhande (Co-coordinator)	9156867201					
2	Drama (performance)	Prof. Arbilya Shaikh (Coordinator)	7020203625			19/01/2018	Evening	Main Stage
		Prof. Geetha Yadur (Co-coordinator)	7038825862					
		Prof. Shakir Hussain (Co-coordinator)	9579105036					
3	Mimicry (competition)	Prof. Nūn Sall (Coordinator)	9503088306			17, 18/01/2019	Evening	Main Stage
		Prof. Mushtaque (Co-coordinator)	8369899145					
4	Mehndi (competition)	Prof. Tasneem Azam (Coordinator)	8007273375			10/01/2019	3:00 PM	
		Sayali Mahajan (Co-Coordinator)	7385097722					
		Prof. Ruchi Rahi (Co-coordinator)	7983904370					
5	Rangoli (competition)	Prof. Rosy Bhol (Coordinator)	9766160629			19/01/2019	10:30 AM	Main Passage
		Prof. Ruchi Rahi (Co-coordinator)	7983904370					
		Mrunali Kokate (Co-coordinator)	7709141560					
6	Floral Decoration (competition)	Prof. Tejal Raut (Coordinator)	9960413634			19/01/2019	10:30 AM	Main Passage
		Tanvi Raut (Co-Coordinator)	9029840796					
7	Best out of Waste	Prof. Azhar Nabi (Coordinator)	826850316			14/01/2019	11:00 AM	
		Prof. Kalamuddin Ansari (Co-coordinator)	8789267489					
		Prof. Vinay Sahu (Co-coordinator)	8655848549					
8	Poster Painting	Prof. Kazi Azimuddin (Coordinator)	9579850730	—		15/01/2019	11:00 AM	
		Prof. S. Reddy (Co-coordinator)	7588434955					
		Prof. Zulfiqar (Coordinator)	9923510075					



*(Signature)*

**PRINCIPAL**  
 THEEM COLLEGE OF ENGINEERING  
 At Village Bethegaon, Boisar Taluka & District Palghar



H. J. Thim Trust's  
**Theem College of Engineering, Boisar**  
 Approved by AICTE (New Delhi), Government of Maharashtra and DTE  
 Affiliated to University of Mumbai

**Jashn-E-Theem 2K19**

Sr. No	Events Name	Staff Coordinator	Staff Coordinator Mobile Number	Student Coordinator	Student Coordinator Mobile Number	Schedule		
						Date	Time	Venue
9	Singing (compitation)	Prof. sholb Khan (Co-coordinator)	9768219633			17/01/2019	Evening	Main Stage
		Prof. Jayshree Sali (Co-coordinator)	9284996588					
10	1. Traditional + Rose day	Prof. Awani Sankhe (Coordinator) Prof. Sanketi Raut (Co-coordinator) Tejas Thakur (Co-coordinator) (Judges are needed in these events :- Internal Judges)	7710023368			08/01/2019	2:30 PM	Main Entrance Gate - Main Stage
	2. Retro+Chocolate day					09/01/2019	2:30 PM	
	3. Mismatch Day					10/01/2019	2:30 PM	
	4. Saree/Formal day					11/01/2019	2:30 PM	
	5. Denim day + Signature day (BE only)					14/01/2019	11:00 AM	
Prof. Ansar Ahmed Shaikh Head Coordinator								



PRINCIPAL  
 THEEM COLLEGE OF ENGINEERING  
 St. Village Brijganj, Boisar Ch./Var. R.  
 Tal. (East) Tal. & Dist. Palghar - 401 201

**SPORTS STORE STCK & ADDITIONAL REQUIRMENTS 2019**

SR NO	Items	Available Quantities in Stock	Required
1	Cricket stumps	13 Nos	3 NOS
2	Cricket bat	7 Nos	3 NOS
3	Tennis ball (heavy) headly	8 Box	10 Ball
4	Tennis ball (light) TENNEX	1 Box	NIL
5	Bails	8 Nos	NIL
6	Grips	9 Nos	2
7	Guard	4 Nos	NIL
8	Foot Ball	2 Nos	6+2
9	Foot Ball Net	4 Nos	NIL
10	Volley Ball	3 Nos	NIL
11	Volley Ball Net	1 Nos	NIL
12	Throw Ball	5 Nos	NIL
13	Badminton Rackets	8 Nos	2
14	Badminton Net	2 Nos	NIL
15	Shuttle Cock	1 Box	2 BOX
16	Carom stand	6 Nos	NIL
17	Carom board	5 Nos	NIL
18	Stricker	8 Nos	NIL
19	Coins	7 Box	NIL
20	Carom Powder	NIL	6 Packets
21	Disc	2 Nos	NIL
22	Shot Put	2 Nos	NIL
23	Javellin	2 Nos	NIL
24	Tug Of war Rope	1 Nos	NIL
25	Jumming Rope	12 Nos	NIL
26	Chess Board	4 Nos+10 Nos	NIL
27	Relay Batten	6 Nos	6
28	Go Clap	2 Nos	NIL
29	Weighing Machine	1 Nos	NIL
30	Measuring tape	3 Nos	NIL
31	Air Pump	4 Nos	Repair
32	Stop Watch	4 Nos	Repair
33	Whistle	NIL	30
34	Marking Rope	1 Nos	300M bundle
35	Mashal	1 Nos	NIL
36	Smily Ball	9 Nos	12 Nos
37	Radium Paper (Night Glow)	NIL	12 sq ft
38	Black Scrap paper	NIL	30 Nos
39	Radium LED Torch	1 Nos	NIL
40	Air Freshner	NIL	6 Nos
41	Marking Powder	NIL	12 bags(20kg)
42	Umpire Round cap	10 NOS	20 Nos
43	Score Book	NIL	12 Nos

119

*Dry Line Marking Machine.*

-NIL  01

*xPatv*



### Intra Sports Event

	No of Players	Trophy	Man of the match	Man Of The Series	Best Bowler	Certificates
Cricket(Boys)	16	2	1			35
Cricket(Girls)	16	2	1	1	1	35
Cricket (Boys-Box)	9	2	1	1	1	20
Cricket (Girls-Box)	9	2	1		1	20
NEON CRICKET(BOYS)	7	2	1		1	14
NEON CRICKET(Girls)	7	2				14
<b>Total</b>		12	4	2	4	138
Football	16	2	1			33
Valley Ball	12	2	1			25
Throw Ball	10	2	1			22
Kabaddi(Boys)	12	2	1			25
Kabaddi(girls)	12	2	1			25
KHO KHO(Boys)	12	2	1			25
KHO KHO(Girls)	12	2	1			25
Tug Of War	8	2				16

Total 334

### Athletic Event

	Gold	Silver	Bronze	Certificate
Chess	2	2	2	6
Running(100m)	2	2	2	6
Running(200m)	2	2	2	6
Relay(100*4)	8	8	8	24
Javelin	2	2	2	6
Shot Put	2	2	2	6
Disc Throw	2	2	2	6
Carrom	6	6		12
Blind Fold	4	4		10
Badminton	5	5		10
	35	35	20	92

### INTER EVENT

	No of Players	Trophy	Man of the match	Man Of The Series	Best Bowler	Certificates
Cricket	16	2	1	1	1	35
Valleyball	12	2			1	25
Football	16	2			1	33
Box Cricket	9	2		1		19
Neon Cricket	7	2				14
<b>Total</b>						126

Total No Of Certificate	552
No of Trophies(Intra)	45
No of Trophies(Inter)	13
Total No Of Trophies	58

Event	Cash Prize
Cricket	5000
Valleyball	3000
Football	5000
Box Cricket	3000
Neon Cricket	1000

Medals	
Gold	35
Silver	35
Bronze	20

T-shirts  
 Team Event — 50 nos. [15 + 15 + 10]  
 Staff — 175 nos.



  
**PRINCIPAL**  
 THEM COLLEGE OF ENGINEERING  
 At Village Binagan, Bolisar, Chikher Road,  
 Bolisar (East) Tal. & Dist. Raichur - 577 101



# “JASHN-E-THEEM 2K19”

## ATHLON 2019

Rush your entries for

# Volleyball

(For Boys)



- Entry fees: Rs 50 (for Boys only)
- Last Date of Registration – 10/01/2019
- Entry forms are available at Xerox Centre (Ground floor)
- For registration & any query please contact Student Coordinators.

#### Student Coordinators

Mr. Chinmay Pimple (9545586931) *Chinmay*  
Mr. Ebad shaikh (7507321656)  
Mr. Manas Pimple (8208245997)  
Mr. Suraj Yadav (8983149401)  
Mr. Pankaj Kushwaha (7276662272)



#### Staff Coordinators

Prof. Rajesh Patil *Rajesh*

*[Signature]*

PRINCIPAL  
THEEM COLLEGE OF ENGINEERING &  
TECHNOLOGY  
Village: Betgaon, Taluka: Chikhalgaon,  
District: Yashwantrao Chavan Pratishthan, Palghar - 401 301

# JASHN-E-THEEM 2019

## ENTRY FORM

*Athlon*

14.Jan-19<sup>th</sup> Jan

NAME OF THE EVENT:- VOLLEYBALL

DEPARTMENT/ CLASS:- FE-DIV-B

CAPTAIN'S NAME:- ~~Kiran Rathod~~ Bobby: Pandey

CONTACT NO:- 9158603551  
8001122871

Sr.No.	Students Full name	Branch/Year	Signature
1	Bobby. Harinarayan. Pandey	Auto. FE-B	
2	<del>Shubham Rathod</del>	<del>FE-B</del>	<del>Shubham Rathod</del>
3	Ayaz Ranasaxiya	FE-B	
4	HUSSAIN. A. SHAIKH	Auto/FE-B	
5	Dhruv Dhule	Auto/fe-B	
6	<del>Harsh. Bhoir.</del>	<del>Auto/fe-B</del>	<del>Harsh. Bhoir.</del>
7	Hitesh. Pal	Comp/Fe-B	
8	Harshikesh Sankhe	IT	
9	<del>Kiran Rathod</del>	<del>Electrical</del>	<del>Kiran Rathod</del>
10	shaal Sujee	FE	
11	yogendra Sharma	FE	
12	Ritik. Shukla	FE	
13	Abhishek S. Mishra.	F.E.	
14	Mafizul M. Shaikh	FE/Mech	
15			

PRINCIPAL

THEEM COLLEGE OF ENGINEERING  
Village Betgaon, Boisar Chikher Road  
Boisar (East) Tal. & Dist. Palghar



# THEEM 2019

## ENTRY FORM

Athlon

9<sup>th</sup> Jan-14<sup>th</sup> Jan

Winner

(19)

NAME OF THE EVENT:- VOLLYBALL

DEPARTMENT/ CLASS:- F.Y. ~~FAET~~(DIP) ME/CE/CO

CAPTAIN'S NAME:- JOSHEL BARI

CONTACT NO:- 9960028308

Sr.No.	Students Full name	Branch/Year	Signature
1	JOSHEL BARI	FY	
2	ZAIN MACHAN	FY	
3	MOZAM	FY	
4	ARKAM MALBARI	FY	
5	Mansoor Shaikh	FY	
6	Kaif Shaikh	FY	
7	KARTIK MHATRE	FY	
8			
9			
10			
11			
12			
13			
14			
15			
16			

*[Handwritten Signature]*

PRINCIPAL  
THEEM COLLEGE OF ENGINEERING  
At Village Betegaon, Borsar Cluster Block  
Dist. East Champaran, Bihar



Note:- Without I.D. card students shall not be allowed to participate in the event



# JASHN-E-THEEM 2019

## ENTRY FORM

*Athlon*

14 Jan-19<sup>th</sup> Jan

NAME OF THE EVENT:- Volley ball

DEPARTMENT/CLASS:- S.E Electrical

CONTAIN'S NAME:- ~~Vijay~~ Joy Manish Yadav

9373279622

CONTACT NO:- 8329589089

Sr.No.	Students Full name	Branch/Year	Signature
1	Pranav Nain	SE [Elect]	
2	RajRajeshwar Deshmukh	SE [Elect]	
3	Manish Yadav	SE [Elect]	
4	Ishaque Khan	SE [Elect]	
5	Panthea Raut	SE [Elect]	
6	Abdulla Mezon	SE [Elect]	
7	shubham patil	SE [Elect]	
8	Akshay sawal	SE [Elect]	
9			
10			
11			
12			
13			
14			
15			
16			

PRINCIPAL  
THEEM COLLEGE OF ENGINEERING  
M. Village Bhatgaon, Bolser Disthar P.  
Disthar (East) Tal. & Disthar P.



Note:- Without I.D. card students shall not be allowed to participate in the event

Principal Sign





# JASHN-E-THEEM 2019

## ENTRY FORM

*Athlon*

14 Jan-19<sup>th</sup> Jan

NAME OF THE EVENT:- Volleyball  
 DEPARTMENT/CLASS:- T.E Civil  
 CAPTAIN'S NAME:- Chinmay Pimple

CONTACT NO:- 9545586931

Sr.No.	Students Full name	Branch/Year	Signature
1	Chinmay Pimple	T.E Civil	
2	Akshay Yadav	T.E Civil	
3	Ebad Shaikh	T.E Civil	
4	Ilyas Bhattar	T.E Civil	
5	Hardik Raut	T.E Civil	
6	<del>Satish Bhardwaj</del> Harad Khan	T.E Civil	
7	Suraj Yadav	T.E Civil	
8	Asif	T.E Civil	
9	Rahul Kustoo Kesrawani	T.E Civil	
10			
11			
12			
13			
14			
15			
16			

Note:- Without I.D. card students shall not be allowed to participate in the event



Principal Sign

Principal Sign



# JASHN-E-THEEM 2019

## ENTRY FORM

*Athlon*

14 Jan-19<sup>th</sup> Jan

NAME OF THE EVENT:- Vollyball  
DEPARTMENT/ CLASS:- Electrical  
OFFICER'S NAME:- Piyush Patil

CONTACT NO:- 7030889541

r.No.	Students Full name	Branch/Year	Signature
1	Piyush Patil	B.E. (Elec)	
2	Akshay Harmalkar	B.E. (Elec)	
3	Jay Rajput	B.E. (Elec)	
4	Shivam Galattkar	T.E. (Elec)	
5	Parag Bhasle	T.E. (Elec)	
6	Prayesh Arkar	T.E. (Elec)	
7	Gauresh Kumbhar	T.E. (Elec)	
8			
9			
10			
11			
12			
13			
14			
15			
16			
17			
18			
19			
20			
21			
22			
23			
24			
25			
26			
27			
28			
29			
30			
31			
32			
33			
34			
35			
36			
37			
38			
39			
40			
41			
42			
43			
44			
45			
46			
47			
48			
49			
50			

Without I.D. card students shall not be allowed to participate in the event

Principal Sign



# JASHN-E-THEEM 2019

## ENTRY FORM

*Athlon*

Volleyball 14 Jan-19<sup>th</sup> Jan

NAME OF THE EVENT:-

DEPARTMENT/ CLASS:- S.E (E) Mechanical

CAPTAIN'S NAME:- Shadab

CONTACT NO:- 7066754543

No.	Students Full name	Branch/Year	Signature
1	Shadab J. Sayyed	Mech/II	<i>Shadab</i>
2	Adarsh M. Raut	Mech/II	<i>Adarsh</i>
3	Yash Bhagat	Mech/II	<i>Bhagat</i>
4	Siddharth Patil	Mech/II	<i>S.Patil</i>
5	Mustafa Ali Sayyed	Mech/II	<i>Mustafa</i>
6	Shyed Sajjad	Mech/II	<i>Sajjad</i>
7	Vishal Yadav	Mech/II	<i>Vishal</i>
8	Salman Makrojiya	Mech/II	<i>Salman</i>
9	Zaid Sayyed	Mech/II	<i>Zaid</i>
10	Ashish Gurav	Mech/II	<i>Ashish</i>
11	Atharv Raut	Mech/II	<i>Raut</i>
12			
13			
14			
15			
16			

Note: Without I.D. card students shall not be allowed to participate in the event

PRINCIPAL  
THEEM COLLEGE OF ENGINEERING  
14 Village Bhatgaon, Bhatgaon Chikar P.  
Tal. East Tal. & Dist. Palghar - 401



Principal Sign  
Principal



# JASHN-E-THEEM 2019

## ENTRY FORM

*Athlon*

14 Jan-19<sup>th</sup> Jan .

NAME OF THE EVENT:- Volleyball

DEPARTMENT/ CLASS:- ~~Me~~ B.E. Mechanical

CAPTAIN'S NAME:- Harshad pagdhare

CONTACT NO:- 9209710296

No.	Students Full name	Branch/Year	Signature
1	Harshad pagdhare	B.E. Mech	H
2	Sahdev goankar		
3	prashant korda		
4	Tanmay mardde		
5	Manthan patel		
6	Inam warsi		
7	Roshan chaturvedi		
8	Nikhil shinde		
9			
10			
11			
12			
13			
14			
15			
16			

Note:- Without I.D. card students shall not be allowed to participate in the event

Principal Sign  
Principal Sign



PRINCIPAL  
THEEM COLLEGE OF ENGINEERING  
St. Village Betegaon, Bazar Chimer  
Dist. Patna

# JASHN-E-THEEM 2019

## ENTRY FORM

*Athlon*

14 Jan-19<sup>th</sup> Jan

NAME OF THE EVENT:- VOLLEYBALL  
 DEPARTMENT/ CLASS:- S.Y. MECH  
 CAPTAIN'S NAME:- USMAN PATEL

CONTACT NO:- 7757864932.

Sr.No.	Students Full name	Branch/Year	Signature
1	Usman Patel	S.Y. Mech	<i>Usman</i>
2	Vivek Bhardwaj	S.Y. Mech	<i>Vivek</i>
3	Spandan Samal	S.Y. Mech	<i>Spandan</i>
4	Arslon Shaikh	S.Y. Mech	<i>Arslon Shaikh</i>
5	Javed Ali	S.Y. Mech	<i>Javed</i>
6	Praduman Chauhan	S.Y. Mech	<i>Praduman</i>
7	Shubham Giri	S.Y. Mech	<i>Shubham</i>
8	Chandraprakash Pandey	S.Y. Mech	<i>Chandraprakash</i>
9	<del>Maaz</del> Shaikh Sufiya Chaudhari	S.Y. Mech	<i>Shaikh Sufiya</i>
10	Vaibhav Rana	S.Y. Mech	<i>Vaibhav</i>
11			
12			
13			
14			
15			
16			

PRINCIPAL  
 THEEM COLLEGE OF ENGINEERING  
 St. Village Betagaon, Borsar Chiller B-  
 Dist. Palghat, Kerala



Without D-card students shall not be allowed to participate in the event

Principal Sign  
 & stamp







# JASHN-E-THEEM 2019

Winner

## ENTRY FORM

Athlon

14 Jan-19<sup>th</sup> Jan

NAME OF THE EVENT:- Volleyball

DEPARTMENT/ CLASS:- T.E. AUTO

CAPTAIN'S NAME:- Krupesh Shinde

CONTACT NO:- 9999927048

Sr.No.	Students Full name	Branch/Year	Signature
1	Krupesh Shinde	Auto / T.E.	
2	Gaurav Borle	Auto / T.E.	
3	Amit Chohan	Auto / T.E.	
4	Devans Waghela	Auto / T.E.	
5	Sagar Pawar	Auto / T.E.	
6	Shreyas Gawade	Auto / T.E.	
7	Santosh Pandey	Auto / T.E.	
8	Ashutosh Chauhan	Auto / T.E.	
9	Uday Sankhe	Auto / T.E.	
10	Kaustubh Vinde	T.E. AUTO	
11	Bhavesh Samavate	S.E. AUTO	
12	Akash Jadhav	S.E. AUTO	
13			
14			
15			
16			

PRINCIPAL  
THEEM COLLEGE OF ENGINEERING  
At Village Biregaon, Borsar Chikar P.  
Borsar (East) Tal. & Dist. Palghar



Note:- Without I.D. card students shall not be allowed to participate in the event

Principal Sign

Principal Sign

# JASHN-E-THEEM 2019

## ENTRY FORM

*Athlon*

14 Jan-19<sup>th</sup> Jan

NAME OF THE EVENT:- Volley ball  
 DEPARTMENT/ CLASS:- F.E(A)  
 CAPTAIN'S NAME:- Ashay Grawane.

CONTACT NO:- 820897252.

Sr.No.	Students Full name	Branch/Year	Signature
1	Ajit G. Dubey	F.E (A)	
2	Ashay Grawane	F.E (A)	
3	Faraz Ahmed	F.E (A)	
4	Rana Nehal	F.E (A)	
5	Sarfraz Khan	F.E (A)	
6	Paras Rushwaha	F.E (A)	
7	Abhishek Jha	F.E (A)	
8	Nooman Khan	F.E (A)	
9			
10			
11			
12			
13			
14			
15			
16			

PRINCIPAL  
 THEEM COLLEGE OF ENGINEERING  
 Village Bategaon, Balesar, District  
 Bargarh (East Tal. & Dist. Pallehar)



Note:- Without I.D. card students shall not be allowed to participate in the event

Principal Sign



Winner

# JASHN-E-THEEM 2019

## ENTRY FORM

Athlon

14 Jan-19<sup>th</sup> Jan

NAME OF THE EVENT:- Volley ball.

DEPARTMENT/ CLASS:- To.Y. mech.

CAPTAIN'S NAME:- Kunjal C. Raut

823795 2546

CONTACT NO:- 8668677495

Sr.No.	Students Full name	Branch/Year	Signature
1	Manas Pimple	To.Y. mech	Raut
2	Dhanum Girawat	To.Y. mech	Dhanum
3	Kunjal Raut	To.Y. mech	Raut
4	Haushal Tandel		Raut
5	Aruny Sankhe	To.Y. mech	Aruny
6	Sohil Bresi	To.Y. mech	Sohil
7	Agasuddin Shukh	To.Y. mech	Agasuddin
8	Faizal Sankhe	To.Y. Coms.	Faizal
9			
10			
11			
12			
13			
14			
15			
16			

*[Handwritten Signature]*

PRINCIPAL

THEEM COLLEGE OF ENGINEERING  
At Village Bilegaon, Boisar Chitli  
Boisar (Dist) Tal. & Dist. Palohar



Note:- Without I.D. card students shall not be allowed to participate in the event

Principal Sign





# JASHN-E-THEEM 2019

**ENTRY FORM**

winner 1st round

*Athlon*

14 Jan-19<sup>th</sup> Jan

NAME OF THE EVENT:-

SPORT/ CLASS:- Ty civil

WINNER'S NAME:- Wasit Ahmad

CONTACT NO:- 7066841925

Sl. No.	Students Full name	Branch/Year	Signature
1	Wasit Ahmad (c)	Ty civil	Wasit
2	Aakif Shaikh	-	Aakif
3	Ganesh	-	Ganesh
4	Umair Khan	-	Umair
5	Ninad Patil	-	Ninad
6	Fardeen	-	Fardeen
7	Abdul Rehman	-	Abdul
8	Rajash	-	Rajash
9	Vaibhava	-	
10			
11			
12			
13			
14			
15			
16			
17			
18			
19			
20			

PRINCIPAL  
THEEM COLLEGE OF ENGINEERING  
At Village Bologach, Bolar Chattri Road,  
Sector East Tal. & Dist. Palghar



Without D. card students shall not be allowed to participate in the event

Principal Sign

# JASHN-E-THEEM 2019

(19)

## ENTRY FORM

*Athlon*

9<sup>th</sup> Jan-14<sup>th</sup> Jan

NAME OF THE EVENT:- Volleyball

DEPARTMENT/ CLASS:- T. & E. Mech A

CAPTAIN'S NAME:- Utkarsh Gharat

CONTACT NO:- 8 30614604  
8 8340588

Sr.No.	Students Full name	Branch/Year	Signature
1	Utkarsh P. Gharat	T-4. MechA	<i>[Signature]</i>
2	Chaitanya Gharat		
3	Dhawal Gharat		
4	adarsh Gharat		
5	Akash rampise		
6	Rohit katker		
7	shoaib Khan		
8	Aniket bore		
9	Sanket kadam		
10	Tunaid. K		
11			
12			
13			
14			
15			
16			

PRINCIPAL  
THEEM COLLEGE OF ENGINEERS  
St. Village Behgaon, Bolisar Chhatrapati  
Bolisar (East) Tal. & Dist. Palghar - 40



Note:- Without I.D. card students shall not be allowed to participate in the event

Principal Sign





H. J. THIM TRUST'S

## THEEM COLLEGE OF ENGINEERING

### NOTICE

Date: 08/01/2019

All the students are hereby informed that, the college level Football (Boys) events will be starting from 12 Jan 2019. All the interested students should enroll your name as Group on or before 10 Jan 2019.

(Entry fees for Group /Team is Rs 50.)

Following Students Coordinators:-

AMIT CHAUHAN (TE MECH)

KARAN SHETTY (SE CIVIL)

SACHIN PATHAK (BE COMP)

SAGAR PAWAR(TE CIVIL)

#### Staff Coordinator

Prof. Abid Manyar

#### Sport Coordinator

Prof. Ansar Shaikh

Prof. Ayaz Bagwan.



PRINCIPAL

THEEM COLLEGE OF ENGINEERING

At Village Betegaon, Boisar Chithar Road

Boisar (East) Tal. & Dist. Palohar - 475 102

# JASHN-E-THEEM 2019

## Football(Boys)

### 12 JAN 2019



**Student Coordinators**  
**Amit Chauhan (TE Mech)**  
**Sachin pathak (BE Comp)**

**Karan Shetty(SE Civil)**  
**Sagar Pawar(TE Civil)**

**Staff Coordinators**  
**Prof Abid Manyar**



  
**PRINCIPAL**  
**THIEM COLLEGE OF ENGINEERING**  
Village Birgaon, Bilas Chhina P.O.  
Dist. East Tal. & Dist. Patna

# JASHN-E-THEEM 2019

19

## ENTRY FORM

Athlon

9<sup>th</sup> Jan-14<sup>th</sup> Jan

NAME OF THE EVENT:- Football  
DEPARTMENT/ CLASS:- AUTO-BOTS  
CAPTAIN'S NAME:- Vrushank

CONTACT NO:- 7875248047

Sr.No.	Students Full name	Branch/Year	Signature
1	Amit Charan	T.E	Amit Charan
2	Krupesh <del>Prab</del> Shinde	TE	Krupesh Shinde
3	Vrushank Amare	B.E	<del>Shinde</del>
4	Kaustubh Vinde	TE	Kinde
5	Chetan Itthape	BE	<del>Itthape</del>
6	Saurabh Raul	TE	Saurabh Raul
7	Sachin Pathak	TE	S.P
8	Karan Shetye	TE	Karan
9	Subodh Chate	BE	<del>Chate</del>
10	Sagar Pawar	TE	S.Pawar
11	Kaustubh	BE	<del>Kaustubh</del>
12	Fariz Momin	TE	Fariz
13	Prathamesh Bare	SE	P. Bare
14			
15			
16			

Note:- Without I.D. card students shall not be allowed to participate in the event



Principal Sign

THEEM COLLEGE OF ENGINEERING, BOISAR

AUTOBOTS TEAM

BRANCH:- AUTOMOBILE

CLASS:- TE

CAPTAIN'S NAME:- Vrushank

Amount Received:-

YEAR:- 2019

(Student Coordinator)

PRINCIPAL  
THEEM COLLEGE OF ENGINEERING  
At Village Boisar, Boisar (Dist. Palghar)



# JASHN-E-THEEM 2019

## ENTRY FORM

Athlon

9<sup>th</sup> Jan-14<sup>th</sup> Jan

NAME OF THE EVENT:-

DEPARTMENT/ CLASS:-

CAPTAIN'S NAME:-

CONTACT NO:-

Sr.No.	Students Full name	Branch/Year	Signature
1	JAI DAPANAND TAMBEL	BE	
2	VAIBHAV LAKMIKANT SHARMA	BE	
3	AASHUTOSH VIJAY KAMBLI	TE	
4	MOHAMMAD AMIN	BE	
5	SAYED SAJAD	SE	
6	DHAWAL SANJAY CHAPAT	TE	
7	MEET MISTRY	TE	
8	MOHAMMED PATEL	BE	
9	VIPUL MORE	BE	
10	SARTHAK PAUT	SE	
11	GAURAV PIMPLE	TE	
12	DEEPAK PARAB	TE	
13	Rohitij Lokhande	TE	
14	Khan Abdul Matin	TE	
15			
16			

Note:- Without I.D. card students shall not be allowed to participate in the event



Principal Sign

THEEM COLLEGE OF ENGINEERING, BOISAR

MECH A TEAM

YEAR:- 2019

BRANCH:- MECH

CLASS:- MECH A

CAPTAIN'S NAME:- AASHUTOSH VIKAMBLI

Amount Received:-

  
(Student Coordinator)

PRINCIPAL  
THEEM COLLEGE OF ENGINEERING  
At Village Boteagan, Boisar Chitambar  
Dist. East Tal. & Dist. Palghar - 40

# JASHN-E-THEEM 2019

## ENTRY FORM

Athlon

9<sup>th</sup> Jan-14<sup>th</sup> Jan

NAME OF THE EVENT:- Football

DEPARTMENT/ CLASS:- Information Tech & Computer

CAPTAIN'S NAME:- Quadir

CONTACT NO:-

Sr.No.	Students Full name	Branch/Year	Signature
1	Shreyas		
2	Quadir		
3	Kartik		
4	Ronak		
5	Saad		
6	Omkar		
7	Amrit		
8	Junaid		
9	Mikhail		
10	Tommy		
11	Faizan		
12	Kaustubh		
13			
14			
15			
16			

Note:- Without I.D. card students shall not be allowed to participate in the event

Principal Sign

THEEM COLLEGE OF ENGINEERING, BOISAR

TEAM

BRANCH:- I.T. & COM'S

CLASS:-

CAPTAIN'S NAME:- Quadir

Amount Received:-

YEAR:-



PRINCIPAL  
THEEM COLLEGE OF ENGINEERING  
At Village Bolegaon, Boisar District  
Taluka (East) Tal. A Dist. Palghar

(Student Coordinator)



# JASHN-E-THEEM 2019

19

## ENTRY FORM

Athlon

9<sup>th</sup> Jan-14<sup>th</sup> Jan

NAME OF THE EVENT:- FOOTBALL  
 DEPARTMENT/ CLASS:- CIVIL  
 CAPTAIN'S NAME:- Shomig Khan

CONTACT NO:- 8007282243 (Shomig)  
 9967920828 (Rugved)

Sr.No.	Students Full name	Branch/Year	Signature
1	NEHAL GUPTA	TE	Neetal
2	RUGVED DICHWALKAR	SE	Rugved
3	KARTHIK SIKLA	SE	Karthik
4	SAHIL PALEKAR	SE	Sahil
5	DHANESH KHATRI	BE	Dhanesh
6	RAVIRAJ KATKAR	BE	Raviraj
7	SOHEL PATEL	BE	Sohel
8	KHAN MOHD SHARIQ	BE	Shariq
9	ISRAFIL BAIG	SE	Israfil
10	SAIF MOHD KHAN	SE	Saif
11	HOZEF SHAIKH	SE	Hozef
12	MILANTH SIGNH	SE	Milanth
13	WAZEED DAINTER	SE	Wazeed
14	BHAVIK B PADHARE	SE	Bhavik
15			
16			

Note:- Without I.D. card students shall not be allowed to participate in the event



Principal Sign

THEEM COLLEGE OF ENGINEERING, BOISAR

TEAM

YEAR:

BRANCH:-  
 CLASS:-  
 CAPTAIN'S NAME:-  
 Amount Received:-

(Student Coordinator)

*Signature*

PRINCIPAL  
 THEEM COLLEGE OF ENGINEERING  
 Village Borgaon, Boisar Tal. & Dist. Palghar



# JASHN-E-THEEM 2019

## ENTRY FORM

*Athlon*

14 Jan-19<sup>th</sup> Jan

NAME OF THE EVENT:- rho-kho  
 DEPARTMENT/CLASS:- D.S.Y (Tech)  
 CAPTAIN'S NAME:- Gulfam Khan

CONTACT NO:- 9323811334

Sr.No.	Students Full name	Branch/Year	Signature
1	Gulfam Khan.		
2	Vaishnav Rasal		
3	Raza		
4	Amaan.		
5	Javed Ali		
6	Pradum Chauhan		
7	Goodke Sagar.		
8	Abhishek Shukla.		
9	Rohit Pandey.		
10	Vivek Bhargava.		
11	Sufiyan.		
12			
13			
14			
15			
16			



Note:- Without LD. card students shall not be allowed to participate in the event

Principal Sign

THEEM COLLEGE OF ENGINEERING, BOISAR

\_\_\_\_\_ TEAM

BRANCH:- DSY Tech  
 CLASS:-  
 CAPTAIN'S NAME:- Gulfam Khan.  
 Amount Received:-

YEAR:-

PRINCIPAL  
 THEEM COLLEGE OF ENGINEERING  
 Village: Bhatgaon, Boisar District: Palitana  
 Taluka: D. & Dist. Palitana

(Student Coordinator)



H. J. THIM TRUST'S

## THEEM COLLEGE OF ENGINEERING

### NOTICE

Date: 07/01/2019

All the students are hereby informed that, the college level Kho-Kho (Boys and Girls) events will be starting from 14 Jan 2019. All the interested students should enroll your name as Group on or before 10 Jan 2019.

(Entry fees for Group /Team is Rs 50.)

Following Students Coordinators:-

VAIBHAV (TE MECH)

JAVELIN ALI ( TE IT)

ROHIT PANDEY (TE EXTC)

GODKE SAGAR ( TE COMP)

#### Staff Coordinator

Prof. Ansar Shaikh

#### Sport Coordinator

Prof. Ansar shaikh

Prof. Ayaz Bagwan.



  
PRINCIPAL  
THEEM COLLEGE OF ENGINEERING  
At Village Betegaon, Borsar Chithar Road  
Borsar (East) Tal. & Dist. Palahar - 47

**JASHN-E-THEEM 2019**

**KHO-KHO**

**14 JAN 2019**



**Student Coordinators**

**Vaibhv (TE Mech)**

**Rohit Pandey (TE Extc)**

**Javelin Ali (TE IT)**

**Godke Sagar(TE Comp)**

**Staff Coordinators**

**Prof Ansar Shaikh (9405734267)**



**PRINCIPAL**

**THEEM COLLEGE OF ENGINEERING**  
12, Village: Betegani, Bolisar, Dist: Dindur  
Dindur (East), Tel. & Dist. Polshin



# JASHN-E-THEEM 2019

ENTRY FORM

Athlons

14 Jan-19<sup>th</sup> Jani

ORGANIZER: KHO-KHO  
 ORGANIZER/CLASS: P.E TREC  
 ADVISOR: MIKHIL SHINDE

CONTACT NO:- 8975753493

Sl. No.	Students Full name	Branch/Year	Signature
1	Mikhail Shinde		
2	Prashant Korda		
3	Harshad Pagdhare		
4	Amit Wagharekar		
5	Rohit Kattkar		
6	Pratik Khondkar		
7	Parag Raut		
8	Utkarsh Ghorat		
9	Sadashiv Sudke		
10	Sunny Kadam		
11	Aakash Ranpise		
12	Rushikesh Pawar		
13	SAHDEV GAONKAR		
14			
15			
16			

Note: Without I.D. card students shall not be allowed to participate in the event



Principal Sign

THEEM COLLEGE OF ENGINEERING, BOISAR

TEAM

BRANCH:-

CLASS:-

CAPTAIN'S NAME:-

Amount Received:-

YEAR:-

PRINCIPAL  
 THEEM COLLEGE OF ENGINEERING  
 At Village Betegaon, Boisar Chikher Road  
 Boisar (East) Tal. & Dist. Palghar

(Student Coordinator)



H. J. THIM TRUST'S

## THEEM COLLEGE OF ENGINEERING

### NOTICE

Date: 10/01/2019

All the students are hereby informed that, the college level Box cricket (Boys) events will be starting from 15 Jan 2019. All the interested students should enroll your name as Group on or before 13 Jan 2019.

(Entry fees for Group /Team is Rs 50.)

Following Students Coordinators:-

CHINMAY (BE CIVIL)

KAIWLAY (SE MECH)

VIPUL (BE CIVIL)

#### Staff Coordinator

Prof. Harshal Ahire

#### Sport Coordinator

Prof. Ansar shaikh

Prof. Ayaz Bagwan.



**PRINCIPAL**  
THEEM COLLEGE OF ENGINEERING  
At. Village Betegaon, Boisar Chithar Road,  
Boisar (East) Tal. & Dist. Palohar - 401 205

# JASHN-E-THEEM 2019

## BOX CRICKET

### 15 JAN 2019



**Student Coordinators**  
**CHINMAY (BE CIVIL)**  
**VIPUL (BE CIVIL)**

**KAIWLAY (SE MECH)**

**Staff Coordinators**  
**Prof Harshal Ahire(8275124797)**





# JASHN-E-THEEM 2019

## ENTRY FORM

*Athlon*

14 Jan-19<sup>th</sup> Jan

NAME OF THE EVENT:- *Base cricket (Girls)*

DEPARTMENT/ CLASS:- *EXTC*

CAPTAIN'S NAME:- *Prajakta Koli*

CONTACT

*7039249352*

Sr.No.	Students Full name	Branch/Year	Signature
1	<i>Prajakta Koli</i>	<i>SF</i>	
2	<i>Masuma Shaikh</i>	<i>BE</i>	
3	<i>Bhakti Yadav</i>	<i>-</i>	
4	<i>Rutika Kalhe</i>	<i>-</i>	
5	<i>Taiba Quadri</i>	<i>-</i>	
6	<i>Shreyoshi Roy</i>	<i>-</i>	
7	<i>Utkarsha Kishi</i>	<i>-</i>	
8	<i>Yashaswi Bari</i>	<i>-</i>	
9			
10			
11			
12			
13			
14			
15			
16			

Note:- Without I.D. card students shall not be allowed to participate in the event

PRINCIPAL  
THEEM COLLEGE OF ENGINEERING  
St. Village Betegaon, Bolisar, Chitaur P.O.  
Dist. Palnour (East) Tal. & Dist. Palnour



Principal Sign



H. J. THIM TRUST'S

## THEEM COLLEGE OF ENGINEERING

### NOTICE

Date: 10/01/2019

All the students are hereby informed that, the college level Tug of war (Boys and Girls) events will be starting from 14 Jan 2019. All the interested students should enroll your name as Group on or before 12 Jan 2019.

(Entry fees for Group /Team is Rs 50.)

Following Students Coordinators:-

PRATIK BHAGAT (TE COMP)

KUNAL AGRE (TE EXTC)

SANKET JADHAV (TE IT)

SHREYAS (SE MECH)

#### Staff Coordinator

Prof. Abid Manyar

Prof. Priti Mali

#### Sport Coordinator

Prof. Ansar shaikh

Prof. Ayaz Bagwan.



PRINCIPAL  
THEEM COLLEGE OF ENGINEERING  
At Village Betegaon, Boisar Chikhar Road  
Boisar (East) Tal. & Dist. Palghar - 401 204

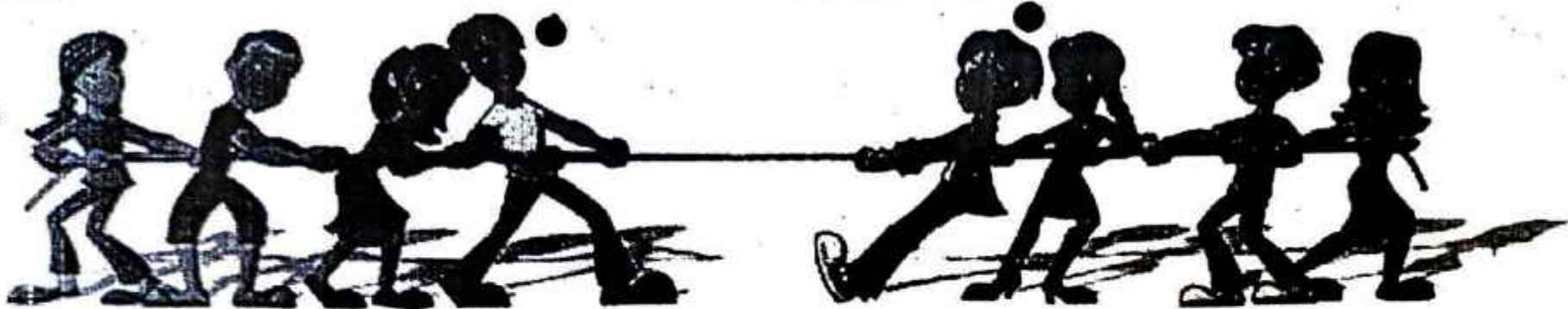

# TUG OF WAR

**ON 14-01-2019**  
**10 AM**



**VENUE:**

**SPORTS GROUND**

**ENTRY FEES: 50 RS**

(Boys)

**LAST DATE OF REGISTRATION**  
**11-01-2019**

**FACULTY COORDINATOR:**

**PROF. TEJAS THAKUR(8149990591)**

**PROF. VINAY SAHU(8655848549)**

**R/WINDRA DAVANE**

**PRATIKSHA WADE**

**SAYALI PIMPLE**

**PRINCIPAL**

**THEEM COLLEGE OF ENGINEERING**  
At Village Betegaon, Borsar Chilhara Road,  
Borsar (East) Tal. & Dist. Palohar - 431 001

**STUDENT COORDINATOR:**

**VIVEK GUPTA(9146270688)**

**ADITYA HINUKALE(9870275600)**

**MOHD TALIB(8796033751)**

**DURGA BHOI(T.E CIVIL)**

**IRAM GAVANDI(B.E CIVIL)**

**~~APURVA BAWASKAR (CIVIL)~~**

**Aakash Singh (S.E. Auto).**  
**Ashish**





# Tug-of-war - Boys.

Athlon - 2019

14/01/2019.

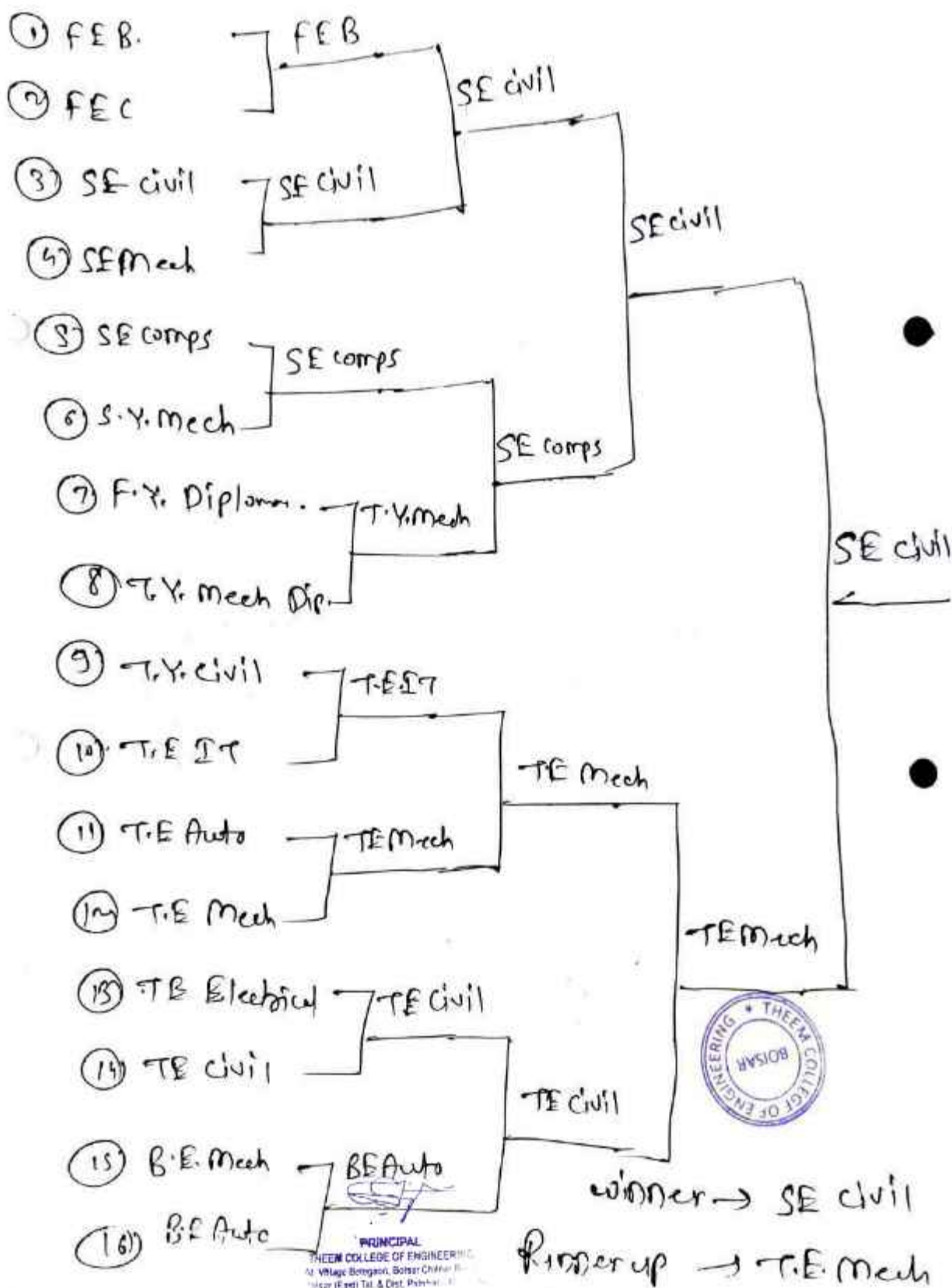

Round 1.

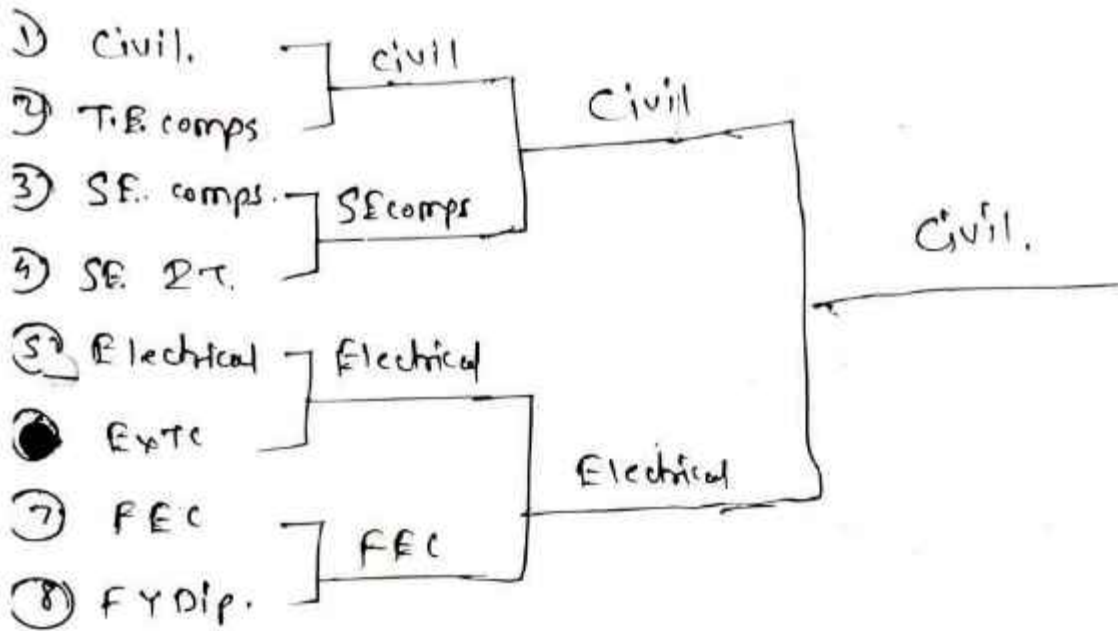

winner → Civil

Runnerup → Electrical.



PRINCIPAL  
THEEM COLLEGE OF ENGINEERING  
Village Bosisip, Bosisip Chhatri  
Palanpur (East) Tal. & Dist. Palanpur

# JASHN-E-THEEM 2019

## ENTRY FORM

Athlon

9<sup>th</sup> Jan-14<sup>th</sup> Jan

Winner

T.E. Mech Boys

19

NAME OF THE EVENT:- Tug of war  
DEPARTMENT/ CLASS:- Mechanical (T.E)  
CAPTAIN'S NAME:- VIVEK SINGH

CONTACT NO:- 9075448494

Sr.No.	Students Full name	Branch/Year	Signature
1	Ishan Mahedav		Ishan
2	Shreyas Bagwe		Shreyas
3	VIVEK Singh		Vivek
4	Yogesh Kamshetti		Yogesh
5	* Pratik Bhagat		Pratik
6	Aaquib Sheikh		Aaquib
7	Panag Raut		Panag
8	* Prince Patil		Prince
9	Sanket Jadhav		Sanket
10	Vishram Sadetkar		Vishram
11	Aakash Rampise		Aakash
12	* Jaimel Ashish		Jaimel
13	Kunal Agre		Kunal
14			
15			
16			

Note:- Without I.D. card students shall not be allowed to participate in the event

Principal Sign

THEEM COLLEGE OF ENGINEERING, BOISAR

BRANCH:- Mechanical TEAM YEAR:-

CLASS:- CAPTAIN'S NAME:- Vivek Singh

Amount Received:- 50/-

PRINCIPAL  
THEEM COLLEGE OF ENGINEERING  
G. Village Bologan, Boisar Chitradistrict  
Dist. Palghar (East) Tal. & Dist. Palghar

Durga Bhoi  
(Student Coordinator)



Tug of war.

Civil-S.E.

Winner:



- 1) Ray Savita - 8208217951
- 2) Mustaqeem
- 3) Beeg Sirapun
- 4) Kartika Shukla
- 5) Ghansham Palke
- 6) Ritik Mehra 8.9967920
- 7) Rungved D. 828.
- 8) Magid
- 9) Minar Sant.

50

==



PRINCIPAL  
THEEM COLLEGE OF ENGINEERING  
Village Bategaon, Bulsar District  
Dist. (East) Tal. X (V.L. P. 1000)

of Mech.

PAGE No.	
DATE	

1. Satyam Sharma (C)
2. Sadashiv Sutar
3. Jayar Shingte
4. Ratan Kashikar
5. Ishikar Pawar
6. Nilesh Yadav
7. Tejmay More
8. Satendra
9. Navin Singh
10. Deepak Khushnars

Winner



*ST*

PRINCIPAL  
THEEM COLLEGE OF ENGINEERING  
M. Village Borsar, Borsar Chitauri  
Dist. Palwal, Haryana

100er

# JASHN-E-THEEM 2019

ENTRY FORM

Athlon

14 Jan-19<sup>th</sup> Jan

SE Mech  
Boys

NAME OF THE EVENT:-  
DEPARTMENT/ CLASS:-  
CAPTAIN'S NAME:-

CONTACT NO:- 8097410468

Sr.No.	Students Full name	Branch/Year	Signature
1	Noumaan Hawaldar	Mech S.E	<i>Noumaan</i>
2	Vedant Sawant	mech S.E	<i>Vedant</i>
3	Aditya phadke	Mech S.E	<i>Aditya</i>
4	Shadab Sayyed	Mech S.E	<i>Shadab</i>
5	Jayesh Vanarase	Mech S.E	<i>Jayesh</i>
6	Atharva Raut	Mech S.E	<i>Atharva</i>
7	Adarsh Raut	Mech S.E	<i>Adarsh</i>
8	Shubham Sonawane	Mech S.E	<i>Shubham</i>
9	Hitesh Jadhav	Mech S.E	<i>Hitesh</i>
10	Ketan Nagpure	Mech S.E	<i>Ketan</i>
11			
12			
13			
14			
15			
16			



Note:- Without I.D. card students shall not be allowed to participate in the event

PRINCIPAL  
TREN COLLEGE OF ENGINEERING  
At Village Belgaon, Bolser Chikar Taluqa  
Dist. Palghar (East) Tal. & Dist. Palghar

Principal Sign



# JASHN-E-THEEM 2019

## ENTRY FORM

Athlon

9<sup>th</sup> Jan-14<sup>th</sup> Jan

Boys

NAME OF THE EVENT:- Tug of war  
DEPARTMENT/ CLASS:- TE (electrical)  
CAPTAIN'S NAME:- Granesh Jainwar

CONTACT NO:- 8655742271

Sr.No.	Students Full name	Branch/Year	Signature
1	Suandera Sangaro	TE (Electrical)	
2	Granesh Jainwar	TE (Elec)	
3	Ashar firoz	TE (Elec)	
4	Swapnil Desai	TE (Elec)	
5	Aril Yadav	TE (Elec)	
6	Nikhil Kori	TE (Elec)	
7	Nitesh Chauhan	TE (Elec)	
8	Mohammad Saad	TE (Elec)	
9	Chandashkhar Rajbhar	TE (Elec)	<u>Shekhar</u>
10	Aghas Ghalandaz	TE (Elec)	
11	Ishaq Khan	TE (Elec)	
12			
13			
14			
15			
16			

Note:- Without I.D. card students shall not be allowed to participate in the event



Principal Sign

THEEM COLLEGE OF ENGINEERING, BOISAR

TEAM

YEAR:-

BRANCH:-

CLASS:-

CAPTAIN'S NAME:-

Amount Received:-

PRINCIPAL  
THEEM COLLEGE OF ENGINEERING  
At Village Boisar, Boisar Circle, Dist. Palghar

(Student Coordinator)

leaver

10550

# JASHN-E-THEEM 2019

ENTRY FORM  
Athlon

T.E Auto Boys

14 Jan-19<sup>th</sup> Jan

NAME OF THE EVENT:- TUG OF WAR  
DEPARTMENT/CLASS:- AUTOMOBILE (TE)  
CAPTAIN'S NAME:- MAYURESH . KADAM

CONTACT NO:- 8879962799

Sr.No.	Students Full name	Branch/Year	Signature
1	AKSHAY. S. MUNDAVE	AUTO/TE	
2	MAYURESH . KADAM	AUTO/TE	
3	AVINASH . KHAYDE	AUTO/TE	
4	SHREYAS. GAWADE	AUTO/TE	
5	SAGAR . SINGH	AUTO/TE	
6	KUNAL. PATIL	AUTO/TE	
7	SURAJ. VISHWAKARMA	AUTO/TE	
8	Niraj . R. Gupta	AUTO/TE	
9	AKASH . GIRI	AUTO/TE	
10	KARAN . SHETTY	AUTO/TE	
11	SAGAR . PAWAR	AUTO/TE	
12	KAUSTUBH. VINDE	AUTO/TE	
13			
14			
15			
16			

Note:- Without I.D. card students shall not be allowed to participate in the event



Principal Sign

THEEM COLLEGE OF ENGINEING,BOISAR

TEAM

BRANCH:- Automobile  
CLASS:- T.E Auto  
CAPTAIN'S NAME:- Sagar Pawar  
Amount Received:- 50/-

YEAR:- 2018-19

PRINCIPAL  
THEEM COLLEGE OF ENGINEERING  
St. Village Bhatapada, Boisar Chitambar  
Dist. (Eath Tal. & Dist. Pooch...

(Student Coordinator)  
Faculty

# JASHN-E-THEEM 2019

ENTRY FORM

Athlon

9<sup>th</sup> Jan-14<sup>th</sup> Jan

TE, BE BT Boys  
1055

(19)

NAME OF THE EVENT:- Tug of war

DEPARTMENT/ CLASS:-

CAPTAIN'S NAME:-

IT

CONTACT NO:-

Sr.No.	Students Full name	Branch/Year	Signature
1	Sagar bhawar	TEIT	
2	Haris Khan	TEIT	
3	Akshay sankhe	BEIT	
4	Prathmesh	BEIT	
5	Shagir	IT	
6	<del>Robert</del> Pallo Chau		
7	Aakash		
8	Muzefa		
9	Shreyas		
10	Phrav Pujari		
11			
12			
13			
14			
15			
16			

Note:- Without I.D. card students shall not be allowed to participate in the event



Principal Sign

THEEM COLLEGE OF ENGINEERING, BOISAR

TEAM

YEAR:-

BRANCH:-  
CLASS:-  
CAPTAIN'S NAME:-  
Amount Received:-

*(Signature)*

PRINCIPAL  
THEEM COLLEGE OF ENGINEERING  
Village Gungaz, Boisar Taluka  
Dist. Palghar

(Student Coordinator)



Winner

F.E-C Boys

# JASHN-E-THEEM 2019

ENTRY FORM

Athlon

14 Jan-19<sup>th</sup> Jan

F.E(C)

NAME OF THE EVENT:-

DEPARTMENT/ CLASS:-

CAPTAIN'S NAME:-

CONTACT NO:-

Sr.No.	Students Full name	Branch/Year	Signature
1	Vikas Sharma	Mech	[Signature]
2	Kartikay Shukla	IT	[Signature]
3	Abhishek Mishra	COM	[Signature]
4	Harsh Raj Singh	COM	[Signature]
5	Rushikesh Shinde	Auto	[Signature]
6	Mahendra Yadav	I.T	[Signature]
7	Atul Upadhyay	COM	[Signature]
8	Jayesh Yadav	Mech	[Signature]
9	Rahul Rana	Elec	[Signature]
10	Itarima Timol	Com	[Signature]
11			
12			
13			
14			
15			
16			



Note:- Without I.D. card students shall not be allowed to participate in the event

Principal Sign

THEEM COLLEGE OF ENGINEERING, BOISAR

TEAM

YEAR:-

BRANCH:-  Mech

CLASS:- F.E(C)

CAPTAIN'S NAME:- Vikas Sharma

Amount Received:- 50

PRINCIPAL  
THEEM COLLEGE OF ENGINEERING  
St. Village Birgaon, Boisar, District Palanpur  
(East Tal. & Dist. Palanpur)

(Student Coordinator)

- 1) Krushita Ambhire
- 2) Jaiee patil
- 3) Nidhi bhavadi
- 4) Shweta ~~parmar~~ parwar
- 5) Nitali parmar
- 6) ~~Sudholi~~ Sudholi P. Gowade
- 7) Dhanshree chaulhan
- 8) Megha

Electrical (T.E) Tug of war

(girls)

9167175470



A stylized handwritten signature in blue ink, appearing to be "S. S. S." or similar.

PRINCIPAL  
THE COLLEGE OF ENGINEERING  
At Village Bongaon, Bonga Chhatra, Dist. Bonga  
P.O. Bonga (East) Tal. & Dist. Bonga

# JASHN-E-THEEM 2019

## ENTRY FORM

Athlon

14 Jan-19<sup>th</sup> Jan

NAME OF THE EVENT:- TUG - OF - WAR

DEPARTMENT/ CLASS:- S.Y. MECH. Pradum

CAPTAIN'S NAME:- ~~PANDEY CHANDEPRAPRAKASH P.P.~~

CONTACT NO:- ~~7248919673~~

7248919673

Sr.No.	Students Full name	Branch/Year	Signature
1	GHEHENSHAH KHAN	MECH.	Ghehen
2	PANDEY CHANDEPRAPRAKASH P.P.	MECH	Spondy
3	Mufarrah Sulaiman A.F	Mech	Sulaiman
4	TEJAS CHAUDHARY	mech	Tejas
5	VIVEK ISHARDWARJ	mech	Vivek
6	Pradum Chauhan	MECH	Pradum
7	Jawad ali Khan	mech	Jawad
8	Sagar ghodke	mech	Sagar
9	Vishwesh padhalk	mech	Vishwesh
10	Faiyaz Shaikh	mech	Faiyaz
11	RITESH KANASTIA	mech	Ritesh
12	Pratik pande	mech	Pratik
13	Vaibhav Pasari	mech	Vaibhav
14	Vicaman patel	mech	Vicaman
15	Arshad	mech	Arshad
16			

Note:- Without I.D. card students shall not be allowed to participate in the event



Principal Sign

THEEM COLLEGE OF ENGINEERING, BOISAR

TEAM

BRANCH:- mech (DIP)

CLASS:- sy

CAPTAIN'S NAME:- Pradum

Amount Received:-

YEAR:-

PRINCIPAL  
THEEM COLLEGE OF ENGINEERING  
At Village Bargaon, Boisar Taluka  
Boisar (Dist. Tal. & Dist. Palanpur)

(Student Coordinator)



# JASHN-E-THEEM 2019

## ENTRY FORM

### Athlon

14 Jan-19<sup>th</sup> Jan

B.E Auto Boys

NAME OF THE EVENT:- Tug of War  
 DEPARTMENT/ CLASS:- B.E. Auto  
 CAPTAIN'S NAME:- Jignesh Patil

CONTACT NO:- 7977731724

Sr.No.	Students Full name	Branch/Year	Signature
1	Jignesh Patil	B.E Auto	Jignesh Patil
2	Omkar Naik	B.E Auto	Omkar Naik
3	Vinay Sawant	B.E Auto	Vinay Sawant
4	Mayuresh Mestry		Mayuresh Mestry
5	Chetan Thape		Chetan Thape
6	Urvesh Patel		Urvesh Patel
7	Mohsin Patel		Mohsin Patel
8	Nikhil Morzary	B.E Auto	Nikhil Morzary
9	Shahbaz Ansari		Shahbaz Ansari
10	Jeet Pandya		Jeet Pandya
11			
12			
13			
14			
15			
16			



Note:- Without I.D. card students shall not be allowed to participate in the event

Principal Sign

THEEM COLLEGE OF ENGINEERING, BOISAR

TEAM

YEAR:-

BRANCH:-  
 CLASS:-  
 CAPTAIN'S NAME:-  
 Amount Received:-

Principal  
 THEEM COLLEGE OF ENGINEERING  
 Village Barogani, Boisar Chitli  
 Dist. Palghar

(Student Coordinator)  
 Faculty

# JASHN-E-THEEM 2019

## ENTRY FORM

*Athlon*

14 Jan-19<sup>th</sup> Jan

*B.E Auto Boys*

NAME OF THE EVENT:- *Tug of War*

DEPARTMENT/ CLASS:- *B.E. Auto*

CAPTAIN'S NAME:- *Jignesh Patil*

CONTACT NO:- *7977731724*

Sr.No.	Students Full name	Branch/Year	Signature	
1	<i>Jignesh Patil</i>	<i>B.E Auto</i>	<i>Jignesh Patil</i>	
2	<i>Omkar Naik</i>	<i>B.E Auto</i>	<i>O.Naik</i>	
3	<i>Vinay Sawant</i>	<i>B.E Auto</i>	<i>Vinay Sawant</i>	
4	<i>Mayuresh Mestry</i>	<i>(Large bracketed signature area)</i>	<i>C. J. Patil</i>	
5	<i>Chetan Ithape</i>		<i>U. J. Patil</i>	
6	<i>Urvesh Patel</i>		<i>U. J. Patil</i>	
7	<i>Mohsin Patel</i>		<i>Mohsin Patel</i>	
8	<i>Nikhil Mantry</i>		<i>B.E Auto</i>	<i>Nikhil Mantry</i>
9	<i>Shahbaz Ansari</i>			
10	<i>Jeet Pandya</i>			<i>Jeet Pandya</i>
11				
12				
13				
14				
15				
16				

Note:- Without I.D. card students shall not be allowed to participate in the event



Principal Sign

THEEM COLLEGE OF ENGINEERING, BOISAR

TEAM

BRANCH:-

CLASS:-

CAPTAIN'S NAME:-

Amount Received:-

YEAR:-

*(Handwritten Signature)*

PRINCIPAL  
THEEM COLLEGE OF ENGINEERING  
Village Boisar, Boisar Chikori P.  
Dist. Palghar - 407 501

(Student Coordinator)

*Faculty*

# JASHN-E-THEEM 2019

## ENTRY FORM

*Athlon*

NAME OF THE EVENT:- TUG OF WAR  
 DEPARTMENT/ CLASS:- S.E. COMP (BOYS)  
 CAPTAIN'S NAME:- Sachin Singh

14 Jan-19<sup>th</sup> Jan

CONTACT NO:- 9112134326

Sr.No.	Students Full name	Branch/Year	Signature
1	Vivek Rai	S.E. Comp	Sachin
2	Abhinav		
3	Sachin		
4	Aashutosh		
5	Sunny		
6	Sudheer		
7	Vivek Gupta		
8	Sandeep		
9	Wasim		
10	Raghu		
11			
12			
13			
14			
15			
16			



Note:- Without I.D. card students shall not be allowed to participate in the event

THEEM COLLEGE OF ENGINEERING, BOISAR

Principal Sign

BRANCH:- S.E. Comp  
 CLASS:- S.E.  
 CAPTAIN'S NAME:- Sachin  
 Amount Received:-

TEAM

YEAR:-

*(Signature)*

PRINCIPAL  
 THEEM COLLEGE OF ENGINEERING  
 Village Bategaon, Boisar Tal. Palghar Dist. Maharashtra

(Student Coordinator)



# JAMNIN-E-THEEM 2019

(19)

## ENTRY FORM

Athlon

FE B Boys

9<sup>th</sup> Jan-14<sup>th</sup> Jan

Winner

NAME OF THE EVENT:- Tug of war.

DEPARTMENT/ CLASS:-

CAPTAIN'S NAME:- Devendra Patole.

CONTACT NO:- 9172650438

Sr.No.	Students Full name	Branch/Year	Signature
- 1	Patole Devendra Sanjay	Comp/FE	Patole
- 2	Mankar Manas Mahendra	mech/FE	Mankar
- 3	<del>Bhair Harsh</del> Bhair Harsh	Auto	<del>Bhair</del>
- 4	Hrishikesh S. Sankhe	IT	Sankhe
- 5	Lingadurai J. Nadar	IT	Lingadurai
- 6	Kiran Rathod	Mech/FE Electrical	Rathod
- 7	Abhishek Nayar	Comp	Abhishek
- 8	Avishkar Jadhav	Auto	A.
- 9	Aman Chaudhasy	Auto	Aman
- 10	Ritik Panjary	Auto	Ritik
- 11	Bobby. Harinarayan. Pandey	Auto	Bobby
- 12	<del>Bhair Harsh</del>	Auto	<del>Bhair</del>
- 13			
- 14			
- 15			
- 16			



Note:- Without I.D. card students shall not be allowed to participate in the event

Principal Sign

**THEEM COLLEGE OF ENGINEERING, BOISAR**

TEAM

BRANCH:- FE  
CLASS:- FE  
CAPTAIN'S NAME:- Patole Devendra Sanjay  
Amount Received:-

YEAR:- FE

(Student Coordinator)

PRINCIPAL  
 THEEM COLLEGE OF ENGINEERING  
 Village: Bhojganj, Boisar Cluster 7  
 Boisar (East) Tal. & Dist. Palghar

# JASHN-E-THEEM 2019

**ENTRY FORM**

*Athlon*

*TE Civil Boys*

14 Jan-19<sup>th</sup> Jan

NAME OF THE EVENT:-

DEPARTMENT/ CLASS:-

CAPTAIN'S NAME:-

CONTACT NO:- 8451856788

Sr.No.	Students Full name	Branch/Year	Signature
1	MD Talha		
2	Pankaj kushwaha.		
3	<del>Ansari shabbajati</del>		
4	Nehal Gupta		
5	Shaykh		
6	Surya		
7	jeish.		
8	iliyas bhobi		
9	pradep		
10			
11			
12			
13			
14			
15			
16			

Note:- Without I.D. card students shall not be allowed to participate in the event

Principal Sign

THEEM COLLEGE OF ENGINEERING, BOISAR

TEAM

YEAR:-

BRANCH:- *Civil*

CLASS:- *I*

CAPTAIN'S NAME:- *MD Talha*

Amount Received:- *50/-*

PRINCIPAL  
THEEM COLLEGE OF ENGINEERING  
At Village Bhatgaon, Boisar Taluka  
Boisar (East) Tal. & Dist. Patan.

*Durga Bhoi*  
(Student Coordinator)

# JASHN-E-THEEM 2019

F.Y. Dip. B.15

## ENTRY FORM

*Athlon*

14 Jan-19<sup>th</sup> Jan

NAME OF THE EVENT:-

DEPARTMENT/ CLASS:- F.Y. Dip. Comp

CAPTAIN'S NAME:- Arkam malbari

CONTACT NO:- 9273924163

Sr.No.	Students Full name	Branch/Year	Signature
1	MALBARI ARKAM	Comp FY Dip	<i>Arkam</i>
2	Adnan Sayyed	Comp F.Y Dip	<i>Adnan</i>
3	Deepraj Raut	Comp F.Y Dip	<i>Deepraj</i>
4	Joshil baaru	Mech F.Y. DIP	<i>Joshil</i>
5	Zain Nachan	Mech F.Y DIP	<i>Zain</i>
6	Moazzam mukadam	Comp F.Y. DIP	<i>Moazzam</i>
7	Rohin Shaikh	Civil F.Y Dip	<i>Rohin</i>
8	Nikhil Satode		
9	M.D Maruf		
10	Yash		
11			
12			
13			
14			
15			
16			

Note:- Without I.D. card students shall not be allowed to participate in the event



PRINCIPAL  
THEEM COLLEGE OF ENGINEERING  
At Warananagar, Dist. Palghar  
Mumbai (East) Tal. & Dist. Palghar

Principal Sign



Lower

T.Y Dip. Mech  
Boys

# JASHN-E-THEEM 2019

## ENTRY FORM

Athlon

14 Jan-19<sup>th</sup> Jan

NAME OF THE EVENT:- Tug of War  
DEPARTMENT/ CLASS:- Mechanical / T.Y  
CAPTAIN'S NAME:- Shahid Shaikh

CONTACT NO:- 8087334097.

Sr.No.	Students Full name	Branch/Year	Signature
1	Dhananjay R. Bhuwad	Mech/T.Y	
2	Swapnil Apte	Mech/T.Y	
3	Shahid Shaikh	Mech/T.Y	
4	Ranjan Gupta	Mech/T.Y	
5	Abhishek Mishwakarma	Mech/T.Y	
6	Swapnil Malawade	Mech/T.Y	
7	Dhiraj R. Koti	Mech/T.Y	
8	Aayush Vaitly	Mech/T.Y	
9	<del>Sarfaraz</del> Arbozz	Mech/T.Y	
10	Ankit Jaiswal	Mech/T.Y	
11	Ravi Yadav	"	
12		"	
13			
14			
15			
16			

Without I.D. card students shall not be allowed to participate in the event



Principal Sign

PRINCIPAL  
THEEM COLLEGE OF ENGINEERING  
At Village Beragaoon, Boisar Chitradurga  
Dist. (East Tal. & Dist. Polhara)

# JASHN-E-THEEM 2019

Dip. Civil B

## ENTRY FORM

Athlon

14 Jan-19<sup>th</sup> Jan

NAME OF THE EVENT:-

DEPARTMENT/ CLASS:- T.Y Civil Dip

CAPTAIN'S NAME:- Wasit Sheikh

CONTACT NO:- 9975612359

Sr.No.	Students Full name	Branch/Year	Signature
1	Manas Tambore	T.Y/Civil	
2	Manas Sanche	—  —	
3	Joseph	+  —	
4	Wasit	—  —	
5	Umar	—  —	
6	Yash	—  —	
7	Prasad	—  —	
8	Swaprup	—  —	
9	Swapnil	—  —	
10	ninad	—  —	
11	ganesh	—  —	
12	vaibhav	+  —	
13	Rajan	—  —	
14			
15			
16			



Note:- Without I.D. card students shall not be allowed to participate in the event

Principal Sign

PRINCIPAL  
THEEM COLLEGE OF ENGINEERING  
Village Bhegaon, Boksa, Chhapra  
Bihar (East) Pin - 851 101

# Tug of War

LOH 3049

STAC

PAGE NO.:

DATE: / /

EXTC

Masuma Shaikh

Bhakti Yadav

Taiba Quadri

Aditi Tamore

Yashasvi Bari

Tanvi Sankhe

Utkarsha Kini

Neha Mhatre ~~(Patil)~~

~~the~~ Umrati Patil

Rutika Kolhe



PRINCIPAL  
THEEM COLLEGE OF ENGINEERING  
14 Village Bilegaon, Bolar Cantonment  
Mumbai East-1st & Dist. Palghar





Losses

# JASHN-E-THEEM 2019

## ENTRY FORM

Athlon

T.E-comps - girls

14 Jan-19<sup>th</sup> Jan

NAME OF THE EVENT:- tug of war  
 DEPARTMENT/ CLASS:- comp (T.E)  
 CAPTAIN'S NAME:- Devashree Patole

CONTACT NO:- 8788453566

Sr.No.	Students Full name	Branch/Year	Signature
1	devashree patole	Comps T.E	
2	ummati patil		
3	Amisa gilani		
4	uati Rama		
5	Nikhil Kham		
6	Apksha Nalawade		
7	Kiranti patil	-11-	
8	shruti patil	-11-	
9	Rakhi zha	-11-	
10	Humera gilani	-11-	
11			
12			
13			
14			
15			
16			

Note:- Without I.D. card students shall not be allowed to participate in the event



Principal Sign

THEEM COLLEGE OF ENGINEERING, BOISAR  
TEAM

BRANCH:-  
 CLASS:-  
 CAPTAIN'S NAME:-  
 Amount Received:-

YEAR:-

PRINCIPAL  
 THEEM COLLEGE OF ENGINEERING,  
 Village Boringan, Boisar District, Tal. Boisar  
 (Eand Tal & Dist. Palghar - 40)

(Student Coordinator)

# JASHN-E-THEEM 2019

FEC

**ENTRY FORM**

*Athlon*

14 Jan-19<sup>th</sup> Jan

FEC Jiny

Losses

OF THE EVENT:- TUG OF WAR  
 TMENT/ CLASS:- FE DIVY'  
 IN'S NAME:- Sabiha Shaikh

CONTACT NO:- 7387307710

Students Full name	Branch/Year	Signature
Sabihanaz.F.Shaikh	FE Comp	<i>Sabihanaz</i>
Kinal.N.Patel	FE IT	<i>Kinal</i>
Prajyoti Gaikwad	FE Comp	<i>Prajyoti</i>
Swarna Sarvankar	FE Comp	<i>Swarna</i>
Laxmi Thakur	FE Comp	<i>Laxmi</i>
Mayuri Umbarsada	FE Comp	<i>Mayuri</i>
Sadhana Chaudhary	FE Comp	<i>Sadhana</i>
Apurva R. Wade	FE IT	<i>Apurva Wade</i>
Swapnali - Sinakar	FE IT	<i>Swapnali</i>
Aakshi Singh	FE IT	<i>Aakshi</i>



at I.D. card students shall not be allowed to participate in the event

Principal Sign

*[Handwritten Signature]*

PRINCIPAL  
 THEEM COLLEGE OF ENGINEERING & TECHNOLOGY  
 Village Bhatgaon, Bihar Chhatar P.O.  
 Bihar (East) Tal. & Dist. Patna

# JASHN-E-THEEM 2019

ENTRY FORM

Athlon

14 Jan-19<sup>th</sup> Jan

Losses

SE - 8<sup>th</sup> girls.

NAME OF THE EVENT:-

DEPARTMENT/ CLASS:-

CAPTAIN'S NAME:-

SE - IT

CONTACT NO:- 7758802639

Sr.No.	Students Full name	Branch/Year	Signature
1	Anchal Tiwari		
2	Dnyanada Padwal		
3	Bhavika Gode		
4	Sakshi Zankhe		
5	Vaishali Dehure		
6	Sakshi Singh		
7	Aditi Mulik		
8	Priyanka Kattkar		
9	Tejashee Mahateer		
10			
11			
12			
13			
14			
15			
16			



Note:- Without I.D. card students shall not be allowed to participate in the event

Principal Sign

THEEM COLLEGE OF ENGINEERING, BOISAR

TEAM

YEAR:-

BRANCH:-

CLASS:-

CAPTAIN'S NAME:-

Amount Received:-

PRINCIPAL  
THEEM COLLEGE OF ENGINEERING  
At Village Bolegaon, Boisar Chittr  
Dist. Palshir

(Student Coordinator)



F.Y. Dip. ① jiny

# JASHN-E-THEEM 2019

## ENTRY FORM

Athlon

14 Jan-19<sup>th</sup> Jan

NAME OF THE EVENT:-

DEPARTMENT/ CLASS:- F.Y. (dip)

CAPTAIN'S NAME:- Aisha Khan

CONTACT NO:- 7559402702

Sr.No.	Students Full name	Branch/Year	Signature
1	Khan Aisha M.d Akram	f.y./comp	<i>Aisha</i>
2	Rina Dillip Patil	I-II-	<i>Rina</i>
3	Mitali Prabhakar Mhatre	-II-	<i>Mitali</i>
4	ANSARI Iram	-II-	<i>Iram</i>
5	Hnima Khan	-II-	<i>Hnima</i>
6	Aastha Patil	<i>Patil</i>	<i>Patil</i>
7	Supriya Mehra	<i>Supriya</i>	<i>Supriya</i>
8	Tejal Lahange	<i>Civil Tejal</i>	<i>Tejal</i>
9			
10			
11			
12			
13			
14			
15			
16			



Note:- Without I.D. card students shall not be allowed to participate in the event

Principal Sign

THEEM COLLEGE OF ENGINEERING, BOISAR  
TEAM

BRANCH:-  
CLASS:-  
CAPTAIN'S NAME:-  
Amount Received:-

YEAR:-

*[Signature]*  
 PRINCIPAL  
 THEEM COLLEGE OF ENGINEERING  
 Village Belegaon, Boisar Ghiring Road,  
 Tal. (East) Tal. & Dist. Palghar.

(Student Coordinator)

# JASHN-E-THEEM 2019

**ENTRY FORM**

*Athlon*

14 Jan-19<sup>th</sup> Jan

S.B. Comps - girls

NAME OF THE EVENT:-

DEPARTMENT/ CLASS:-

CAPTAIN'S NAME:-

*2<sup>nd</sup> year (comps)*

CONTACT NO:- 8459234208

Sr.No.	Students Full name	Branch/Year	Signature
1	Ashlesha Matkar	} COMPS II <sup>nd</sup> Year	
2	Anjali Ghate		
3	Masuma Sathe		
4	Duhita Raut		
5	Bhagyashree Motne		
6	Sanya Damanwala		
7	Jyoti Pawar		
8	Rishana Sheerin.P.		
9			
10			
11			
12			
13			
14			
15			
16			



Note:- Without I.D. card students shall not be allowed to participate in the event

Principal Sign

THEEM COLLEGE OF ENGINEERING, BOISAR

TEAM

YEAR:-

PRINCIPAL  
THEEM COLLEGE OF ENGINEERING  
M. Village Betejain, Boisar Chikhar R.  
Dist. (Erat) Tal. & Dist. Pathe...

BRANCH:-

CLASS:-

CAPTAIN'S NAME:-

Amount Received:-

(Student Coordinator)

Civil-girls.

# JASHN-E-THEEM 2019

ENTRY FORM

*Athlon*

14 Jan-19<sup>th</sup> Jan

NAME OF THE EVENT:-  
DEPARTMENT/ CLASS:-  
CAPTAIN'S NAME:-

*Civil* *Tug of war*

CONTACT NO:- 8788802030

Sr.No.	Students Full name	Branch/Year	Signature
1	Apurva Baviskar	S.E Civil	
2	Sheha Kandelkar	S.E Civil	
3	Ketki Jadyar	S.E Civil	
4	Rashi Tamore	T.E Civil	
5	Durga Bhoi	T.E Civil	
6	Riddhi Rathod	T.E Civil	
7	Ankita kadam	T.E Civil	
8	Iram Cravandi	B.E Civil	
9	Mansi Torase	S.E Civil	
10	Riddhi Tandell	T.E Civil	
11	Disha Alisrao	S.E Civil	
12			
13			
14			
15			
16			

Note:- Without I.D. card students shall not be allowed to participate in the event

THEEM COLLEGE OF ENGINEERING, BOISAR

TEAM

YEAR:-

Principal Sign



PRINCIPAL  
THEEM COLLEGE OF ENGINEERING  
At Village Bolegaon, Boisar District Palghar (East) Tal. & Dist. Palghar

BRANCH:-  
CLASS:-  
CAPTAIN'S NAME:-  
Amount Received:-

(Student Coordinator)





H. J. THIM TRUST'S

## THEEM COLLEGE OF ENGINEERING

### NOTICE

Date: 10/01/2019

All the students are hereby informed that, the college level Box cricket (Boys) events will be starting from 15 Jan 2019. All the interested students should enroll your name as Group on or before 13 Jan 2019.

(Entry fees for Group /Team is Rs 50.)

Following Students Coordinators:-

CHINMAY (BE CIVIL)

KAIWLAY (SE MECH)

VIPUL (BE CIVIL)

#### Staff Coordinator

Prof. Harshal Ahire

#### Sport Coordinator

Prof. Ansar shaikh

Prof. Ayaz Bagwan.



**PRINCIPAL**  
THEEM COLLEGE OF ENGINEERING  
At. Village Betegaon, Boisar Chithar Road,  
Boisar (East) Tal. & Dist. Palohar - 401 205

# JASHN-E-THEEM 2019

## BOX CRICKET

### 15 JAN 2019



**Student Coordinators**  
**CHINMAY (BE CIVIL)**  
**VIPUL (BE CIVIL)**

**KAIWLAY (SE MECH)**

**Staff Coordinators**  
**Prof Harshal Ahire(8275124797)**



**PRINCIPAL**  
**THEEM COLLEGE OF ENGINEERING**  
10, Village Borigauri, Baramati, Dist. Solapur  
Maharashtra, India. Tel: & Dist. Solapur

# JASHN-E-THEEM 2019

## ENTRY FORM

*Athlon*  
[Box Cricket] Entry fee - 100 Rs

NAME OF THE EVENT:-

DEPARTMENT/ CLASS:- SE (Elect) (B)

CAPTAIN'S NAME:- Mahesh Mahadik

CONTACT NO:-

*Saurabh*

Sr.No.	Students Full name	Branch/Year	Signature
1	Jayesh Norvekar C	Elect.	<i>[Signature]</i>
2	Tejash Gurav	EE-	<i>[Signature]</i>
3	Mahesh Mahadik		<i>[Signature]</i>
4	<del>Mani</del> Suresh. Singh		<i>[Signature]</i>
5	manish zanjara		<i>[Signature]</i>
6	shrawan Morya		<i>[Signature]</i>
7	Rajrajeshwar Deshpande		<i>[Signature]</i>
8	Akshay Sawant		<i>[Signature]</i>
9	Amandeep shing		<i>[Signature]</i>
10			

Note:- Without I.D. card students shall not be allowed to participate in the event



*[Signature]*  
Coordinator Sign

*[Signature]*

PRINCIPAL  
THEEM COLLEGE OF ENGINEERING  
At Village Betegeon, Boisar Chittha B.  
Boisar (East) Tal. & Dist. Palghar.



# JASHN-E-THEEM 2019

## ENTRY FORM

*Athlon*

14 Jan-19<sup>th</sup> Jan

NAME OF THE EVENT:- Box Cricket (girls)

DEPARTMENT/ CLASS:- CIVIL

CAPTAIN'S NAME:- Iqram Gawandi

CONTACT NO:- 7030441954

Sr.No.	Students Full name	Branch/Year	Signature
1	Iqram Gawandi	BE	
2	Samiksha Patil	TE	
3	Rakshita More	TE	
4	Ankita Kadam	TE	
5	Manasi Torse	SE	
6	Disha Ahirao	SE	
7	Priyanka	FE	
8	Nikita	FE	
9	Durga	TE	
10	Riddhi	TE	
11	Sayyoni	TE	
12			
13			
14			
15			
16			

Note:- Without I.D. card students shall not be allowed to participate in the event

Principal Sign

THEEM COLLEGE OF ENGINEERING, BOISAR

\_\_\_\_\_ TEAM

BRANCH:-

CLASS:-

CAPTAIN'S NAME:-

Amount Received:-

YEAR:-

PRINCIPAL  
THEEM COLLEGE OF ENGINEERING  
Village Boisar, Boisar Tal. Dist. Palghar

(Student Coordinator)

# JASHN-E-THEEM 2019

## ENTRY FORM

*Athlon*

14 Jan-19<sup>th</sup> Jan

NAME OF THE EVENT:- Boze Cricket (Girls)  
DEPARTMENT/ CLASS:- Electrical,  
CAPTAIN'S NAME:- Sudhali Gawade

CONTACT NO:- 9167175470.

Sr.No.	Students Full name	Branch/Year	Signature
1	Sudhali Gawade	TE	
2	Shruti Kamble	TE	
3	Megha Ingale	BE	
4	Krishita Ambhore	SE	
5	Jaije Patil	SE	
6	Dhanashri Chaudhary	TE	
7	Shweta Pawar	SE	
8	Mitali Parmar	SE	
9			
10			
11			
12			
13			
14			
15			
16			



*[Handwritten Signature]*

PRINCIPAL  
THEM COLLEGE OF ENGINEERING  
St. Vinay Dargapur, Boisar, Chitaur P.  
Dist. Solapur - 431 002, Maharashtra

Note:- Without I.D. card students shall not be allowed to participate in the event

Principal Sign

THEM COLLEGE OF ENGINEERING, BOISAR

\_\_\_\_\_ TEAM

BRANCH:-

CLASS:-

CAPTAIN'S NAME:-

Amount Received:-

YEAR:-

(Student Coordinator)

# JASHN-E-THEEM 2019

## ENTRY FORM

*Athlon*

14 Jan-19<sup>th</sup> Jan

NAME OF THE EVENT:- *Base cricket (Girls)*

DEPARTMENT/ CLASS:- *Diploma Computers*

CAPTAIN'S NAME:- *Atisha Shaikh*

CONTACT NO:-

Sr.No.	Students Full name	Branch/Year	Signature
1	<i>Alisha Shaikh</i>	<i>TY</i>	
2	<i>Akanksha Wade</i>	<i>TY</i>	
3	<i>Sanjali Mhatre</i>	<i>TY</i>	
4	<i>Smriti Lade</i>	<i>TY</i>	
5	<i>Hemangi Toke</i>	<i>TY</i>	
6	<i>Jannat Shaikh</i>	<i>SY</i>	
7	<i>Pradnya Patil</i>	<i>TY</i>	
8	<i>Rina Patil</i>	<i>FY</i>	
9			
10			
11			
12			
13			
14			
15			
16			

Note:- Without I.D. card students shall not be allowed to participate in the event

Principal Sign

THEM COLLEGE OF ENGINEING, BOISAR

\_\_\_\_ TEAM

YEAR:-

BRANCH:-

CLASS:-

CAPTAIN'S NAME:-

Amount Received:-

(Student Coordinator)



# JASHN-E-THEEM 2019

## ENTRY FORM

*Athlon*

14 Jan-19<sup>th</sup> Jan

NAME OF THE EVENT:- Box cricket

DEPARTMENT/ CLASS:- FE

CAPTAIN'S NAME:- Sadhana Chaudhary

CONTACT NO:- 9870454255

Sr.No.	Students Full name	Branch/Year	Signature
1	Sadhana Chaudhary	FE	
2	Prajyoti Gaikwad.	---	
3	Swarnupa Sarvankar	---	
4	Sabiha Sheikh	---	
5	Kinal Patel	---	
6	Siddhi Chatter.	---	
7	Shreya Dani	---	
8			
9			
10			
11			
12			
13			
14			
15			
16			



*[Signature]*

PRINCIPAL

THEEM COLLEGE OF ENGINEERING  
 St. Village Betegada, Boisar Chikar  
 Near I.E. Rd. & Dist. Palghar

Note:- Without I.D. card students shall not be allowed to participate in the event

Principal Sign

THEEM COLLEGE OF ENGINEERING, BOISAR

\_\_\_\_\_ TEAM

BRANCH:- \_\_\_\_\_ YEAR:- \_\_\_\_\_

CLASS:- \_\_\_\_\_

CAPTAIN'S NAME:- \_\_\_\_\_

Amount Received:- \_\_\_\_\_

(Student Coordinator)

# JASHN-E-THEEM 2019

## ENTRY FORM

*Athlon*

14 Jan-19<sup>th</sup> Jan

NAME OF THE EVENT:- *Boxe Cricket (girls)*

DEPARTMENT/CLAS :- *Computers*

CAPTAIN'S NAME:- *Unnati Patil*

CONTACT NO:- *7559419209*

Sr.No.	Students Full name	Branch/Year	Signature
1	<i>Unnati Patil</i>	<i>TF</i>	
2	<i>Apeksha Nalawade</i>	<i>---</i>	
3	<i>Kirnali Patil</i>	<i>---</i>	
4	<i>Nikhil Khan.</i>	<i>---</i>	
5	<i>Devashri Patole.</i>	<i>---</i>	
6	<i>Urvi Rana.</i>	<i>---</i>	
7	<i>Humera Gilani</i>	<i>---</i>	
8	<i>Anisa Gilani</i>	<i>---</i>	
9			
10			
11			
12			
13			
14			
15			
16			



PRINCIPAL  
THEEM COLLEGE OF ENGINEERING  
11, Village: Boisar, District: Solapur, P.

Note:- Without I.D. card students shall not be allowed to participate in the event

Principal Sign

THEEM COLLEGE OF ENGINEERING, BOISAR  
\_\_\_\_\_ TEAM  
YEAR:-  
BRANCH:-  
CLASS:-  
CAPTAIN'S NAME:-  
Amount Received:-  
(Student Coordinator)

# JASHN-E-THEEM 2019

## ENTRY FORM

*Athlon*

14 Jan-19<sup>th</sup> Jan

NAME OF THE EVENT:- Box cricket (girls)  
 DEPARTMENT/ CLASS:- IT  
 CAPTAIN'S NAME:- Aditi

CONTACT NO:- 9136718659

Sr.No.	Students Full name	Branch/Year	Signature
1	Aditi	SA	
2	Kajal	—	
3	Priyanka	—	
4	Anchal Tiwari	—	
5	Dnyanada Padwal	—	
6	Sakshi Sankhe	—	
7	Bhavika Gode.	—	
8	Nidhi Chavhan	TE	
9	Sona Yadav	—	
10			
11			
12			
13			
14			
15			
16			



*[Signature]*

PRINCIPAL  
 THEEM COLLEGE OF ENGINEERING  
 Village Boisar, Boisar Taluka, Dist. Palghar

Note:- Without I.D. card students shall not be allowed to participate in the event

Principal Sign

THEEM COLLEGE OF ENGINEERING, BOISAR

\_\_\_\_\_ TEAM

BRANCH:- \_\_\_\_\_ YEAR:- \_\_\_\_\_

CLASS:- \_\_\_\_\_

CAPTAIN'S NAME:- \_\_\_\_\_

Amount Received:- \_\_\_\_\_

(Student Coordinator)



25  
Feb.

Wbm

S.Y

# JASHN-E-THEEM 2019

## ENTRY FORM

Athlon

[Box Cricket]

Entry fee - 100 Rs

NAME OF THE EVENT:- Box Cricket.

DEPARTMENT/ CLASS:- Mechanical Second Year, (A)

CAPTAIN'S NAME:- omkar khade.

CONTACT NO: 9162163946

Sr.No.	Students Full name	Branch/Year	Signature
1	Omkar Khade		
2	Vivek Bhardwaj	ME / II	<i>[Signature]</i>
3	Sagar Godke	ME / II	<i>[Signature]</i>
4	Gulfam Khan.	ME / II	<i>[Signature]</i>
5	Rohit Pandey.	ME / II	<i>[Signature]</i>
6	Ahsan Shaikh.	ME / II	<i>[Signature]</i>
7	Umaji	ME / II	<i>[Signature]</i>
8	Javed Ali	ME / II	<i>[Signature]</i>
9	Praduman Chauhan.	ME / II	<i>[Signature]</i>
10	Shubham Gijji.	ME / II	<i>[Signature]</i>

Note:- Without I.D. card students shall not be allowed to participate in the event



*[Signature]*

Coordinator Sign

9145455720

*[Signature]*

PRINCIPAL  
THEEM COLLEGE OF ENGINEERING  
St. Village Bologan, Bolisar Chitradurga  
562125

9 8 (4) (1) (3) (8)

# JASHN-E-THEEM 2019

## ENTRY FORM

*Athlon*  
[Box Cricket] Entry fee - 100 Rs

NAME OF THE EVENT:-  
DEPARTMENT/ CLASS:- TE IT  
CAPTAIN'S NAME:- Ankit Yadav

983418047  
913748402  
CONTACT NO:- 815956536

Sr.No.	Students Full name	Branch/Year	Signature
1	Ajay Yadav	I.T/TE	Ajay
2	Shubham mithra	I.T/TE	
3	Sagar Bhasin	I.T/TE	
4	Lucky Singh	I.T/TE	
5	Ankit Yadav	IT/TE	Ank
6	shubham sharma	"	
7	Ali	"	
8	Vikesh	"	
9	Samir	"	
10	Durgesh	"	

Note:- Without I.D. card students shall not be allowed to participate in the event



*[Signature]*  
Coordinator Sign

*[Signature]*

PRINCIPAL  
THEEM COLLEGE OF ENGINEERING  
St. Village Bologan, Bolser District  
Jalor (East) Tal. & Dist. Palsani

2019

# JASHN-E-THEEM 2019

win toss  
field

## ENTRY FORM

Athlon

[Box Cricket]

Entry fee - 100 Rs

NAME OF THE EVENT:- Box cricket  
DEPARTMENT/ CLASS:- F-E A2  
CAPTAIN'S NAME:- Akshay Gadhar

CONTACT NO:- 8208972252

Sr.No.	Students Full name	Branch/Year	Signature
1	Ajit G. Dubey	IT/FE-A	<i>[Signature]</i>
2	Hanish Bari	Mech/FE-A	<i>[Signature]</i>
3	Akshay Gadhar	C.S/FEA	<i>[Signature]</i>
4	Ashay Grawane	IT/FE-A	<i>[Signature]</i>
5	Nehal Rana	Civil/FE-A	<i>[Signature]</i>
6	Nikhil Lyavara	Mech/FE-A	
7	Paras Kushwaha	IT/FE-A	<i>[Signature]</i>
8	<del>Ritik Choudhary</del> Mishra	EXTC/FE-A	<i>[Signature]</i>
9	<del>Vishal Patil</del> Mishra	IT/FE-A	<i>[Signature]</i>
10	Nitin Mishra	IT/FE-A	<i>[Signature]</i>

Note:- Without I.D. card students shall not be allowed to participate in the event



*[Signature]*  
Coordinator Sign

*[Signature]*  
PRINCIPAL  
THEEM COLLEGE OF ENGINEERING  
Village Borsan, Borsan, Dist. Patna



Won.

(4)

# JASHN-E-THEEM 2019

## ENTRY FORM

*Athlon*  
[Box Cricket]

Entry fee - 100 Rs

NAME OF THE EVENT:- Box cricket  
DEPARTMENT/ CLASS:- T.E Electrical  
CAPTAIN'S NAME:- Parag

(A)

CONTACT NO:- 779809054

Sr.No.	Students Full name	Branch/Year	Signature
1	Parag A Bhosale	T.E	<i>Bhosale</i>
2	Prayot Arekar	T.E	
3	Nicchal Dawane	T.E	
4	Gaurresh kumbhar.	T.E	
5	Sagar Tare.	T.E	
6	Akash govind patil	T.E	
7	ishaque Khan	T.E	
8	chinmay macchi	T.E	
9	Nitesh dhodi	T.E	
10	mayur Gujar	T.E	

Note:- Without I.D. card students shall not be allowed to participate in the event

*[Signature]*

PRINCIPAL  
THEEM COLLEGE OF ENGINEERING  
Village Bhatgaon, Bhatgaon Chitambar  
Dist. East Tal. & Dist. Palghar



*[Signature]*  
Coordinator Sign

# JASHN-E-THEEM 2019

ENTRY FORM

Athlon

9<sup>th</sup> Jan-14<sup>th</sup> Jan

win

NAME OF THE EVENT:- Box Cricket

DEPARTMENT/ CLASS:- ME S.Y.M.E

CAPTAIN'S NAME:- ~~Adarsh Raut~~ Prajwal

Box  
Cricket

7507706522  
CONTACT NO:- 7020235787

Sr.No.	Students Full name	Branch/Year	Signature
1	Prajwal Kini		
2	Adarsh Raut		
3	Tanmay logle		
4	Apurv Patil		
5	Hitesh Jadhav		
6	Ketan Nagpure		
7	Yash bhagat		
8	Ashish Gurav		
9	Ashutosh Raut		
10	Nikhillesh Patil		
11	Mufaddal		
12	Kartik patil		
13	Aditya Phadke		
14	Atharv Raut		
15			
16			

Note:- Without I.D. card students shall not be allowed to participate in the event



PRINCIPAL  
THEEM COLLEGE OF ENGINEERING  
St. Village Borsar, Borsar Office P.  
Dist. Palghar (East) Tal. & Dist. Palghar

5

win

# JASHN-E-THEEM 2019

## ENTRY FORM

*Athlon*  
[Box Cricket]

Entry fee - 100 Rs

NAME OF THE EVENT:-  
DEPARTMENT/ CLASS:- T.Y. CIVIL  
CAPTAIN'S NAME:- Ninad Patil

CONTACT NO:- 797278710

Sr.No.	Students full name	Branch/Year	Signature
1	Ninad Patil	Civil/T.Y	<i>[Signature]</i>
2	Conesh Ventha	Civil/T.Y	<i>[Signature]</i>
3	Rajan Vishwakarma	—	
4	ovesh Arab	—	
5	yash sanke	—	<i>[Signature]</i>
6	Fardin Kaulamiker	—	
7	rutik patil	—	<i>[Signature]</i>
8	nabi sheikh	—	
9	wasid sheikh	—	
10	Vipin Vaikhan binnor	—	

Note:- Without I.D. card students shall not be allowed to participate in the event

*[Signature]*  
Coordinator Sign

*[Signature]*

PRINCIPAL  
THEEM COLLEGE OF ENGINEERING  
At Village Belgaur, Borsar Chikar P.O.  
Dist: Raichur Tal. & Dist. Polwar.





Win

# JASHN-E-THEEM 2019

## ENTRY FORM

*Athlon*

[Box Cricket]

Entry fee - 100 Rs

NAME OF THE EVENT:- BOX CRICKET

DEPARTMENT/CLASS:- ETRX (B.E)

CAPTAIN'S NAME:- Viddhesh Gharat

CONTACT NO:- 9096657972

Sr.No.	Students Full name	Branch/Year	Signature
1	Viddhesh Gharat	B.E ETRX	
2	Gaurav Mishra	B.E ETRX	
3	Rahul Mishra	B.E. Mech	
4	Rana Singh.	B.E. ETRX	
5	Sunil Prajapati	B.E. ETRX	
6	Prajwal Naik	B.E Mech	
7	Prerak Hegde	B.E ETRX	
8	Moinuddin Khan.	B.E ETRX	
9	Neelkanth thakur	B.E. Civil	
10	Shailish Singh.	B.E. ETRX	

Note:- Without I.D. card students shall not be allowed to participate in the event

PRINCIPAL  
THEEM COLLEGE OF ENGINEERING  
Village Botegaon, Botehr Chikar  
Boisar (East) Tal & Dist. Palghar - 401



Coordinator Sign

# JASIN-E-THEEM 2019

## ENTRY FORM

Woj

Athlon

Toss win  
Bowling

9<sup>th</sup> Jan-14<sup>th</sup> Jan

NAME OF THE EVENT:- box cricket  
 DEPARTMENT/ CLASS:- T. & Mech. A (degree)  
 CAPTAIN'S NAME:- Utkarsh Gharat

CONTACT NO:- 8390614609  
 8788340588

Sr.No.	Students Full name	Branch/Year	Signature
1	Utkarsh P. Gharat	T.4.mech	<u>Gharat</u>
2	chaitanya gharat		
3	Dhawal Gharat		
4	sanket kadam		
5	Rohit katker		
6	Amit W.		
7	viraj kandalgankar		
8	lukmaan		
9	Aniket bose		
10	Rakesh mi'shra		
11			
12			
13			
14			
15			
16			



Note:- Without I.D. card students shall not be allowed to participate in the event

*[Handwritten Signature]*

Principal Sign

PRINCIPAL  
 THEEM COLLEGE OF ENGINEERING  
 At Village Biregan, Boisar District R.  
 Dist. (East) Tal. & Dist. Palghar - 40

Won

# JASHN-E-THEEM 2019

## ENTRY FORM

Toss win  
Bowling

Athlon  
[Box Cricket]

Entry fee - 100 Rs

NAME OF THE EVENT:- 300 cricket

DEPARTMENT/ CLASS:- T.Y. mech.

CAPTAIN'S NAME:- Ator Dheerum

CONTACT NO:-

Sr.No.	Students Full name	Branch/Year	Signature
1	Dheerum Ghatak		
2	Kemal Rana		
3	Arbaz Shaikh		
4	Mouzaam Shaikh		
5	Muneeb Pimple		
6	Ajman Shaikh		
7	Shufin Shaikh		
8	Ahmed Mulla		
9	Zain Mulla		
10	Kemal Rana		

Note:- Without I.D. card students shall not be allowed to participate in the event



*[Signature]*  
Coordinator Sign

PRINCIPAL  
THEEM COLLEGE OF ENGINEERING  
M. Village Boregan, Bhor Chitli P.  
Dist. East Tal. & Dist. Palghar



# JASHN-E-THEEM 2019

Won

## ENTRY FORM

Toys with  
Bowling

Athlon

[Box Cricket]

Entry fee - 100 Rs

NAME OF THE EVENT:-

DEPARTMENT/ CLASS:- BE / Civil

CAPTAIN'S NAME:-

CONTACT NO:- 97026274

Sr.No.	Students Full name	Branch/Year	Signature
1	Sameer Pathan		
2	Shivanandan		
3	Raviraj		
4	Malik Abdul		
5	Mithal Amar		
6	Shabbaz		
7	Mane		
8	Zulphakar		
9	Shubham		
10	RAM Dhananjay Hamid		

Note:- Without I.D. card students shall not be allowed to participate in the event



PRINCIPAL  
THEEM COLLEGE OF ENGINEERING  
Ac. Village Bategaon, Baisar Chattri St.  
Dist. Palani



Coordinator Sign

# JASHN-E-THEEM 2019

ENTRY FORM

Athlon

Loss

(2)

9<sup>th</sup> Jan-14<sup>th</sup> Jan

NAME OF THE EVENT:-

FECC (2)

DEPARTMENT/ CLASS:-

Jatyam. U.

CAPTAIN'S NAME:-

~~Mahendra S. Yadav~~ Yadav

CONTACT NO:- 96657148

Sr.No.	Students Full name	Branch/Year	Signature
✓ 1	Mahendra S Yadav (captain)	FE/IT	<i>Mahendra S Yadav</i>
✓ 2	Mafizul M. Shaikh	FE/Mech	<i>Mafizul</i>
✓ 3	Hemraj Singh	FE/Comp.	<i>Hemraj Singh</i>
✓ 4	Atul K. Upadhyay	FE/Comp	<i>Atul</i>
✓ 5	Shubham Govarikar	FE/Elec.	<i>Shubham</i>
✓ 6	Jatyam Yadav	FE/Mech	<i>Jatyam</i>
✓ 7	Rahul Rana	FE/Elec	<i>Rahul</i>
✓ 8	Abhishek Mishra	FE/Comp	<i>Abhishek</i>
✓ 9	Rahul Talekar	FE/Comp.	<i>Rahul</i>
✓ 10	Hrishikesh Shinde	FE/Auto	<i>Hrishikesh</i>
11	Dhiraj Kumar	FE/Com	
12	Vikash Sharma	FE/mech	
13			
14			
15			
16			



Note:- Without I.D. card students shall not be allowed to participate in the event

Principal Sign

*[Signature]*

PRINCIPAL  
THEEM COLLEGE OF ENGINEERING  
At Village Betsgaon, Borsar Chikar  
Dist. Palghar - 40

Loss

# JASHN-E-THEEM 2019

## ENTRY FORM

*Athlon*

[Box Cricket]

Entry fee - 100 Rs.

NAME OF THE EVENT:-

DEPARTMENT/ CLASS:- B.E / Comp

CAPTAIN'S NAME:- Dilip Sharma

CONTACT NO:- 800708364

Sr.No.	Students Full name	Branch/Year	Signature
1	Dilip Sharma	Com/B.E	Shivan
2	Shivam Singh	Com/B.E	Shiva
3	Abhijeet Bhagat	—	
4	Devendra Rajput	—	
5	Omkar	—	
6	Quadir	—	
7	Zaid	—	
8	Shreeram	—	
9	Aakash Mishra	—	
10	Vaibhav Singh	—	

Note:- Without I.D. card students shall not be allowed to participate in the event

  
Coordinator Sign





Principal Sign

THEEM COLLEGE OF ENGINEERING  
22, Village Belgaon, Bolisar Chitwan  
Chitwan (East) Tal. & Dist. Patanchi



Loss

# JASHN-E-THEEM 2019

To win  
Battling

## ENTRY FORM

Athlon

[Box Cricket]

Entry fee - 100 Rs

NAME OF THE EVENT:- BOX CRICKET

DEPARTMENT/ CLASS:- FE-DIV-B

CAPTAIN'S NAME:- Rajkumar R. Yadav

CONTACT NO:- 8879967609

Sr.No.	Students Full name	Branch/Year	Signature
1	BOBBY H. PANDEY	Auto/FE	<i>[Signature]</i>
2	YOJENDRA SHARMA	IT/F.E	<i>[Signature]</i>
3	RAJKUMAR YADAV	IT/FE	<i>[Signature]</i>
4	JAY VELKAR	Auto/FE	<i>[Signature]</i>
5	SATYAM SINGH	IT/FE	<i>[Signature]</i>
6	Hrishikesh S. Sankh	IT	<i>[Signature]</i>
7	Hussain saikh	Auto	<i>[Signature]</i>
8	Ritesh Shukla	IT	<i>[Signature]</i>
9	Prashant S Pal	Mech	<i>[Signature]</i>
10	Vikash Pansipadi	Mech	<i>[Signature]</i>

Note:- Without I.D. card students shall not be allowed to participate in the event

*[Signature]*  
Coordinator Sign



*[Signature]*

PRINCIPAL  
Village Betgaon, Boisar District Palanpur

# JASHN-E-THEEM 2019

## ENTRY FORM

*Athlon*  
[Box Cricket]

Entry fee - 100 Rs

NAME OF THE EVENT:-

DEPARTMENT/ CLASS:- Automobile (B.E.)

CAPTAIN'S NAME:- Jignesh Patil

7875248047  
CONTACT NO:- 8149412315

Sr.No.	Students Full name	Branch/Year	Signature
1	Jignesh Patil	BE AUTO	Jignesh Patil
2	Vrushank Amre	BE AUTO	Vrushank Amre
3	Mayuresh Meshy	BE AUTO	Mayuresh Meshy
4	Aditya Devalekhar	BE AUTO	Aditya
5	Vinay Sawant	BE AUTO	Vinay
6	Vinay Patil	BE AUTO	V. J. Patil
7	Vaibhav Makur	BE AUTO	Vaibhav
8	Sagar Chitambar	BE AUTO	Sagar
9	Chetan Itape	BE AUTO	Chetan
10	Himesh Kale	BE Auto	Himesh

Note:- Without I.D. card students shall not be allowed to participate in the event



Coordinator Sign

PRINCIPAL  
THEEM COLLEGE OF ENGINEERING  
Village Bologan, Boisar Taluka  
Dist. Palghar

Principal Sign

Loss

# JASHN-E-THEEM 2019

## ENTRY FORM

*Athlon*

[Box Cricket]

Entry fee - 100 Rs

NAME OF THE EVENT:- Box Cricket

DEPARTMENT/ CLASS:- S.E/Civil

CAPTAIN'S NAME:- Hozef Shaikh

CONTACT NO:- 8698414533

Sr.No.	Students Full name	Branch/Year	Signature
1	Hozef Shaikh.	S.E/Civil	
2	Arshad Shaikh.		
3	Hashim Shaikh.		
4	Hritik Meher		
5	Minar Raut		
6	Rugved Dichwalkar		
7	Kartik Shukla		
8	Ishak Chaudhari		
9	Shashank Singh		
10	Shashi Kanajiya		

Note:- Without I.D. card students shall not be allowed to participate in the event



PRINCIPAL

THEEM COLLEGE OF ENGINEERING  
42, Village Bodegao, Boken Chittr II,  
Dist. (East) Tal. & Dist. Palsani



Coordinator Sign



# JASHN-E-THEEM 2019

## ENTRY FORM

Loss

Athlon

[Box Cricket]



Entry fee - 100 Rs

NAME OF THE EVENT:-

DEPARTMENT/CLASS:- Civil/T.E

CAPTAIN'S NAME:- SURAJ YADAV

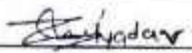
CONTACT NO:- 8983149401 / 86687

Sr.No.	Students Full name	Branch/Year	Signature
1	YADAV SURAJ	Civil/T.E	
2	Satish Bharadwaj	Civil/T.E	
3	Chinmay Pimple	Civil/T.E	
4	<del>Amit K. Mane</del> <del>Abhishek Kulkarni</del> <del>Abhishek Kulkarni</del>	Civil/T.E	
5	Ehad Shaikh	Civil/T.E	
6	Girish Phadatar	Civil/T.E	
7	Ilyas Bhati	Civil/T.E	
8	Hitesh Mehta	Civil/T.E	
9	Pankaj Khuswa	Civil/T.E	
10	Ruhul Kesarvadi	Civil/T.E	

Note:- Without I.D. card students shall not be allowed to participate in the event

Coordinator Sign

  
PRINCIPAL  
THEEM COLLEGE OF ENGINEERS  
At Village Bhatgaon, Bhatgaon Chikhal  
Dist. (East) Tal. & Dist. Patehar



Principal Sign

LOSS

# JASHN-E-THEEM 2019

## ENTRY FORM

*Athlon*  
[Box Cricket] Entry fee - 100 Rs

NAME OF THE EVENT:-  
DEPARTMENT/ CLASS:- *B.E IIT*  
CAPTAIN'S NAME:- *Vivid tare*

CONTACT NO:- *9965086901*  
*9209293592*

Sr.No.	Students Full name	Branch/Year	Signature
1	<i>Abshay Pandey</i>		<i>Abshay</i>
2	<i>Nikhil mate</i>		<i>Nik</i>
3	<i>Ashay Sanche</i>		<i>Ash</i>
4	<i>Vividtare</i>		<i>vivid</i>
5	<i>prathmesh chaudhari</i>		<i>P</i>
6	<i>Saajin Khavn</i>		<i>S</i>
7	<del><i>Ganesh Ganesh</i></del>		<del><i>G</i></del>
8	<i>Tushar Pandey</i>		<i>Tushar</i>
9	<i>akash Yadav</i>		<i>Akash</i>
10	<i>Bhaveri Yadav Kumavat</i>		<i>B</i>

Note:- Without I.D. card students shall not be allowed to participate in the event

*P. Anand*  
Coordinator Sign

*[Signature]*  
PRINCIPAL  
THEEM COLLEGE OF ENGINEERING  
So. Village Bategaon, Bhatnagar District  
Gurgaon (Haryana) India



Loss

# JASHN-E-THEEM 2019

## ENTRY FORM

*Athlon*

[Box Cricket]

Entry fee - 100 Rs

NAME OF THE EVENT:- BOX CRICKET  
DEPARTMENT/ CLASS:- SEC IT  
CAPTAIN'S NAME:-

CONTACT NO:- 9004279415

Sr.No.	Students Full name	Branch/Year	Signature
1	Saad Khan	SE-IT	
2	Chirag Mande	SE IT	
3	Shubham Dalvi	SE IT	
4	Vishal Singh	SE IT	
5	Vaibhav Neman	SE IT	
6	Tejas Mahade	SE IT	
7	Nilesh Dave	SE IT	
8	Nitesh Talekar	SE IT	
9	Roshan Kamble	SE IT	
10	Tanmay Bore	SE IT	

Note:- Without I.D. card students shall not be allowed to participate in the event

  
PRINCIPAL  
THEEM COLLEGE OF ENGINEERING  
Village Bhatgaon, Bhatgaon, Chikar P.  
Solapur (Dist. Tal. & Dist. Palner)



  
Coordinator Sign

Principal Sign



# JASHN-K-THEEM 2019

COB

## ENTRY FORM

Athlon

1000 Field

9<sup>th</sup> Jan-14<sup>th</sup> Jan

NAME OF THE EVENT:- Box cricket  
 DEPARTMENT/ CLASS:- G. E Mech (B)  
 CAPTAIN'S NAME:- Sidhart Patil

CONTACT NO:- 9049826487

Sr.No.	Students Full name	Branch/Year	Signature
1	Arbaaz Shaikh		[Signature]
2	Ritik Singh		[Signature]
3	Sidharth Patil (C)		[Signature]
4	Sagar Ambale (WC)		[Signature]
5	Chandan Pandey		[Signature]
6	Haryhad Patil		[Signature]
7	Shrikant Patil		[Signature]
8	Bhavik Tamore		[Signature]
9	Smith Bari		[Signature]
10	VishwaviJog Singh		[Signature]
11	Numan Shaikh		[Signature]
12			
13			
14			
15			
16			



Note:- Without I.D. card students shall not be allowed to participate in the event

Principal Sign

Principal Sign

[Signature]

PRINCIPAL  
 THEEM COLLEGE OF ENGINEERING  
 At, Village Borsar, Borsar Taluk, Dist. Palghar - 407 501

# JASHN-E-THEEM 2019

## ENTRY FORM

*Athlon*

[Box Cricket]

Entry fee - 100 Rs

NAME OF THE EVENT:- Ent Box Cricket  
 DEPARTMENT/CLASS:- Electrical (S.E)  
 CAPTAIN'S NAME:- Viraj madhav

CONTACT NO:- 7506587567

Sr.No.	Students Full name	Branch/Year	Signature
-1	Durgesh P. Raut	SE Elect	
-2	Viraj V. Madhav	-	
-3	Sankip Jalge		
-4	Viraj Raut		
5	Shubam Patil		
6	<del>Dadasaheb Bhatnagar</del> Manish Zangare		
7	<del>Suraj Biradar</del> Abjulla Paig		
-8	<del>Raj Rameshwar</del> Tejas Gurav		
9	<del>Manish Mahalik</del> Ishaque Khan		
10	<del>Manish Zangare</del>		

Note:- Without I.D. card students shall not be allowed to participate in the event

  
 PRINCIPAL  
 THEEM COLLEGE OF ENGINEERING  
 St. Village Bategaon, Borsar Chikar  
 Dist. (East) Tal. & Dist. Palghar



Coordinator Sign

Principal Sign

Loss

(3)

# JASHN-E-THEEM 2019

## ENTRY FORM

Athlon  
[Box Cricket]

Entry fee - 100 Rs

NAME OF THE EVENT:-

DEPARTMENT/ CLASS:- B.E. Mechanical

(A)

CAPTAIN'S NAME:-

CONTACT NO:-

Sr.No.	Students Full name	Branch/Year	Signature
1	Nikhil Shinde	B.E. Meeh.	
2	Prashant Korda.		
3	Harshad pagdhare.		
4	Roshan Chaturvedi.		
5	Sadashiv sudke.		
6	Rushikesh Pawar.		
7	Prachit Raut.		
8	Tanmay made.		
9	Ajay machi		
10	Sunny Kadam.		

Note:- Without I.D. card students shall not be allowed to participate in the event



PRINCIPAL  
THEEM COLLEGE OF ENGINEERING  
St. Village Breggaon, Bhamar Chhatrapati  
Dist. Palghar



  
Coordinator Sign





H. J. THIM TRUST'S

## THEEM COLLEGE OF ENGINEERING

### NOTICE

Date: 08/01/2019

All the students are hereby informed that, the college level Open cricket intra (Boys) events will be starting from 12 Jan 2019. All the interested students should enroll your name as Group on or before 10 Jan 2019.

(Entry fees for Group /Team is Rs 50.)

Following Students Coordinators:-

CHINMAY (SE CIVIL)

VIPUL (SE CIVIL)

#### Staff Coordinator

Prof. Harshal Ahire

#### Sport Coordinator

Prof. Ansar Shaikh

Prof. Ayaz Bagwan.



PRINCIPAL  
THEEM COLLEGE OF ENGINEERING  
At. Village Betegaon, Bosisar Chitkar Road  
Bosisar (East) Tal. & Dist. Palohar - 401 101

# JASHN-E-THEEM 2019

## CRICKET

### 12 JAN 2019



**Student Coordinators**  
**CHINMAY (SE CIVIL)**

**VIPUL (SE CIVIL)**

**Staff Coordinators**  
**Prof Harshal Ahire(8275124797)**



  
**PRINCIPAL**  
THEEM COLLEGE OF ENGINEERING  
Village: Bengach, Borsar Chikla  
Dist: (East), Tal: A. D. H. Pith...

# JASHN-E-THEEM 2019

## ENTRY FORM

*Athlon*

9<sup>th</sup> Jan-14<sup>th</sup> Jan

NAME OF THE EVENT:- Cricket (open)  
DEPARTMENT/CLASS:- T.E. mech (n)  
CAPTAIN'S NAME:- Aniket Bore

2 → 9545812355  
CONTACT NO:- 8788340588

Sr.No.	Students Full name	Branch/Year	Signature
1	Sanket. S. Kadam	TE mech (n)	
2	Utkarsh. P. Gharat	TE mech (n)	
3	Chaitanya. S. Gharat	TE mech (n)	
4	Dhaval. Gharat	TE mech (n)	
5	Viraj. Khandolgaonkar	TE mech (n)	
6	Rohit. Katkar	TE mech (n)	
7	Lukman. Mulla	TE mech (n)	
8	Amit	TE mech (n)	
9	Aniket. Bore		<i>Aniket Bore</i>
10	Jiggesh		
11	Akash. Ranpise		
12	Rakesh. Mishra		
13	Vidit. Sankhe		
14	Vinest. Sankhe		
15	Khan Abdulmatin		
16	Rajan Pandey		

Note:- Without I.D. card students shall not be allowed to participate in the event

Principal Sign



*[Signature]*  
PRINCIPAL  
THEEM COLLEGE OF ENGINEERING  
1st Village Betegaon, Boisar Taluka, Dist. Palghar



# JASHN-E-THEEM 2019

ENTRY FORM

Athlon

9<sup>th</sup> Jan-14<sup>th</sup> Jan

(5) → (6)

NAME OF THE EVENT:- Cricket open

DEPARTMENT/CLASS:- Auto SE

CAPTAIN'S NAME:- Akash Jadhav

CONTACT NO:- 7083236064

Sr.No.	Students Full name	Branch/Year	Signature
1	Jashwin Ambhire	SE / Auto	
2	Suraj Patil	SE / Auto	
3	Aditya Hirukale	- " -	
4	Dhanesh Rathod	- " -	
5	Akash Jadhav	- " -	
6	Salman Shaikh	- " -	
7	Shravanth H. Padigachi	- " -	
8	Ashish Singh	- " -	
9	Vikas Rajpurshit	- " -	
10	Manshad Mansuree	- " -	
11	Suraj shetty	- " -	
12	<del>Rajpurshit Vikas</del>	<del>- " -</del>	
13	Suraj sawant	- " -	
14	Sawant Kaivalya	- " -	
15	Somavate Bhavesh	- " -	
16			

Note:- Without I.D. card students shall not be allowed to participate in the event

Principal Sign



PRINCIPAL  
THEEM COLLEGE OF ENGINEERING  
Village Botegeoni, Borsar Chitli  
Dist. Palghar



# JASHN-E-THEEM 2019

## ENTRY FORM

Athlon

9<sup>th</sup> Jan-14<sup>th</sup> Jan

(4) → (L)

NAME OF THE EVENT:- CRICKET  
DEPARTMENT/CLASS:- Computer / S.E.  
CAPTAIN'S NAME:- ANSAR AHMED

CONTACT NO:- 8975530756

Sr.No.	Students Full name	Branch/Year	Signature
1	ANSAR JALIL AHMED -	Comp/S.E.	
2	SACHIN SINGH -	=  =	
3	SUNNY GUPTA -	=  =	
4	MOHD. TALIB ANSARI -	=  =	
5	X ASHISH BIND -	=  =	
6	ABHAY GIRI -	=  =	
7	REHAN MANSOORI -	=  =	
8	MEHUL BHOI -	=  =	
9	PRATHAMESH HADALGEKAR -	=  =	
10	NITESH GUPTA -	=  =	
11	IRSHAD MANSURI	=  =	
12	HEMANT SHETTY	=  =	
13	SANDEEP JAISWAR	=  =	
14	HASHIM PATHAN	=  =	
15	X ANKIT THAKUR	=  =	
16	X VIVEK GUPTA	=  =	

Note:- Without I.D. card students shall not be allowed to participate in the event

Principal Sign

PRINCIPAL  
THEEM COLLEGE OF ENGINEERING  
Village Belgachia, Bolmer Chhatra Panchayat  
Ghor (East), Tel. & Dist. Patna





# JASHN-E-THEEM 2019

ENTRY FORM

Athlon

9<sup>th</sup> Jan-14<sup>th</sup> Jan

(2) → (L)

NAME OF THE EVENT:- Cricket

DEPARTMENT/CLASS:- FE / Div C

CAPTAIN'S NAME:- Bhavesh Waghmare

CONTACT NO:- 9527520002

Sr.No.	Students Full name	Branch/Year	Signature
1	Arishikesh S. Shinde	Auto/FE	
2	Mayuresh Sutar	Comp/FE	
3	Bhavesh Waghmare	Mech/FE	
4	Ranay Prabhu	Electrical/FE	
5	Dipesh Ghodke	Electrical/FE	
6	Satyam Yadav	Mech/FE	
7	Harshraj Singh	Comp/FE	
8	Mahendra Yadav	IT /FE	
9	Shubham Gavalkar	Electrical/FE	
10	Nikhil Sankhe	Electrical/FE	
11	Atul Upadhyay	Comp /FE	
12	Ketan Shrivastav	Electrical/FE	
13	Aakash Gond	Electrical/FE	
14	Om Prakash Singh	/FE	
15	Rahul Talekar	Comp /FE	
16	Abhishek Mishra	Comp /FE	

Note:- Without I.D. card students shall not be allowed to participate in the event

Principal Sign

PRINCIPAL  
THEEM COLLEGE OF ENGINEERING  
At Village Bhabgaon, Boisar Tal. Palanpur Dist. Palanpur





# ASHN-E-THEEM 2019

ENTRY FORM

Athlon

9<sup>th</sup> Jan-14<sup>th</sup> Jan

(1) → E

19

NAME OF THE EVENT:- Cricket P.Y

DEPARTMENT/ CLASS:- Computer

CAPTAIN'S NAME:- Shaibaz

Mob: 9765455806

CONTACT NO:- 956112451

Sr.No.	Students Full name	Branch/Year	Signature
1	Zain		
2	Arkam		
3	Shakebuz		
4	Faizan		
5	Raza		
6	Mouazzam		
7	Ruhain		
8	Joshi		
9	Razik		
10	Shahid		
11	Navin Yash		
12	Aman Adnan.		
13			
14			
15			
16			

Note:- Without I.D. card students shall not be allowed to participate in the event

Principal Sign



PRINCIPAL  
THEEM COLLEGE OF ENGINEERING  
At, Village Betegaon, Bolser Chitgarh  
Dist. Patkhar

# JASHN-E-THEEM 2019

## ENTRY FORM

Athlon

9<sup>th</sup> Jan-14<sup>th</sup> Jan

(1) (W)

NAME OF THE EVENT:- Cricket

DEPARTMENT/ CLASS:- Civil / 3<sup>rd</sup> Year Diploma

CAPTAIN'S NAME:- Ganesh Varthga / Umar Khan

CONTACT NO:- 7507201002

Sr.No.	Students Full name	Branch/Year	Signature
1	Ninad patil	Civil/III	Ninad
2	Umar Khan	Civil/III	Umar
3	Wasit Ahmad	Civil/III	Wasit
4	Vaibhav Juneed Suruchi	Civil/III	Vaibhav
5	Ganesh Varthga	Civil/III	Ganesh
6	Fardin Kaularikar	Civil/III	Fardin
7	Rajan Vishwakarma	Civil/III	Rajan
8	Nabi Shaikh	Civil/III	Nabi
9	Akif Shaikh	Civil/III	Akif
10	Yash Sonche	Civil/III	Yash
11	Manash (Rutik patil)	Civil/III	Manash
12	Shubham Patil Vubhu bin	Civil/III	Shubham
13	Ovesh - patil Arab	Civil/III	Ovesh
14	Sai Nalawade	Civil/III	Sai
15	Sayyed Rubain	Civil/III	Sayyed
16	Vincent D Yadav	SY CIVIL	Vincent

Note:- Without I.D. card students shall not be allowed to participate in the event

Principal Sign



PRINCIPAL  
THEEM COLLEGE OF ENGINEERING  
At Village Betegaon, Boisar Chikar  
Boisar (East) Tal. & Dist. Palghar



# JASHN-E-THEEM 2019

ENTRY FORM

Athlon

9<sup>th</sup> Jan-14<sup>th</sup> Jan

(S) → (W)

NAME OF THE EVENT:- cricket  
DEPARTMENT/CLASS:- Electrical (SE)  
CAPTAIN'S NAME:- Viraj Madhav

CONTACT NO:- 7506587567

Sr.No.	Students Full name	Branch/Year	Signature
✓ 1	Viraj Viraj Madhav	BSE Electri	Viraj
✓ 2	Sankalp Jalge	-u-	Jalge
✓ 3	Viraj Raut	-u-	Raut
✓ 4	Shubham Patil	-11-	Spatil
✓ 5	Durgesh Raut	-11-	Raut
✓ 6	Dadasbheb Bangar	S.E Electri	Raut
✓ 7	Raj Rajeshwar	-11-	Raj
8	Shravan Morya	-11-	Morya
✓ 9	Abdullah Baig	-11-	Baig
✓ 10	Suraj Biradhar	S.E electric	Biradhar
11	Tejas Gurav	-11-	Gurav
12	omkar shinde	-11-	Omkar
✓ 13	Manish Zanjare	S.E electric	Zanjare
✓ 14	Ishaq Khan	-11-	Ishaq
15	Mandar Kishan Mandel	-11-	Mandel
16	Saurav Porth Raut	S.E electric	Raut

Note:- Without I.D. card students shall not be allowed to participate in the event

Principal Sign



PRINCIPAL  
THEEM COLLEGE OF ENGINEERING  
At Village Boregaon, Boisar Chitradistrict  
Boisar (East) Tal. & Dist. Palanpur



# JASHN-E-THEEM 2019

ENTRY FORM

Athlon

9<sup>th</sup> Jan-14<sup>th</sup> Jan

(1) → (W)

(2)

NAME OF THE EVENT:-

DEPARTMENT/ CLASS:-

CAPTAIN'S NAME:-

F.E. (A)  
Ajit G. Dubey

CONTACT NO:- 8208 97252 ✓

Sr.No.	Students Full name	Branch/Year	Signature
1	Hanish Baliram Bari	Mech (F.E.A)	
2	Nehaal Tejal Rana	Civil (F.E.A)	
3	Akshay Gorakharth Jadhav	F.E (A)	
4	Ashay Gawane	F.E (A)	
5	Sarfraz Khan	F.E (A)	
6	Paras kushwaha	F.E (A)	
7	Ajit dubey	F.E (A)	
8	Faraz ahmed	F.E (A)	
9	Mudassar shaikh	civil (F.E)	
10	Nooman khan	Mech (F.E)	
11	MEHTAB ALI CHAUDHARY	F.E (A)	
12	Rizzan Sayyed	F.E (A)	
13	Nilesh Badgajar	F.E (A)	
14	Vivek Patel	F.E (A)	
15	Abhishek Jha	F.E (A)	
16	Nitin Mishra	F.E (A)	

Note:- Without I.D. card students shall not be allowed to participate in the event

Principal Sign

THEM COLLEGE OF ENGINEING, BOISAR

TEAM

BRANCH:-

CLASS:-

CAPTAIN'S NAME:-

Amount Received:-



YEAR:- F.E Div-(A)

THEM COLLEGE OF ENGINEERING  
St. Village Behgaon, Boisar Chittr P.  
Boisar (East) Tal. & Dist. Palnhar

(Student Coordinator)

# JASHN-E-THEEM 2019

19

## JASHN-E-THEEM 2019

### ENTRY FORM

Athlon

9<sup>th</sup> Jan-14<sup>th</sup> Jan

(4) → (W)

NAME OF THE EVENT:- cricket  
 DEPARTMENT/ CLASS:- BE civil  
 CAPTAIN'S NAME:- Bhandari Shubham

CONTACT NO:- 9976121592

Sr.No.	Students Full name	Branch/Year	Signature
1	Bhandari Shubham		
2	Mithul Shah		
3	Samir Pathan		
4	Tegav Patil		
5	Anur Bidwai		
6	Harud Ansari		
7	Aniket More		
8	Shamikha Khan		
9	Raviraj Katkar		
10	Bhishanandon Prujapati		
11	Shubhay Anani		
12	Shubham Sharma		
13	Shaikh Md. Abid		
14			
15	Jeevai Yadav		
16	Umesh Pawale		

Note:- Without I.D. card students shall not be allowed to participate in the event

Principal Sign

THEEM COLLEGE OF ENGINEERING, BOISAR

TEAM

BRANCH:- BE-Civil

CLASS:-

CAPTAIN'S NAME:- Bhandari Shubham

Amount Received:- 1001-



YEAR:-

PRINCIPAL  
 THEEM COLLEGE OF ENGINEERING  
 Village Boorgan, Boisar Chittr P.  
 Dist. (East Tal. & Dist. Palghar)

*(Signature)*  
 (Student Coordinator)



# JASHN-E-THEEM 2019

19

## ENTRY FORM

Athlon

9<sup>th</sup> Jan-14<sup>th</sup> Jan

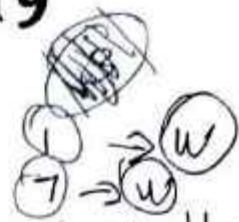

Medhaj Jashi

NAME OF THE EVENT:- Cricket  
 DEPARTMENT/ CLASS:- Mech (2nd year) (B)  
 CAPTAIN'S NAME:- Bicumar

CONTACT NO:- 9769081750

Sr.No.	Students Full name	Branch/Year	Signature
1	Medhaj Jashi	Mech	m.j.jashi
2	Zahid Patel	Mech	Zahid
3	Hitesh	Mech	Hitesh
4	Yash Chauri	Mech	Yash
5	<del>Yash</del> Ashutosh Raut	Mech	Ashutosh
6	Tanmay	Mech	Tanmay
7	Ashish	Mech	Ashish
8	Satish	Mech	Satish
9	Arsalan	Mech	Arsalan
10	Yash Bhagat	Mech	Yash
11	Atharva	Mech	Atharva
12	Nikhilash	Mech	Nikhilash
13	Ketan	Mech	Ketan
14	Brajwal	Mech	Brajwal
15	Apurva	Mech	Apurva
16	Aadharsh	Mech	Aadharsh

Note:- Without I.D. card students shall not be allowed to participate in the event

Principal Sign

**THEEM COLLEGE OF ENGINEERING, BOISAR**

TEAM \_\_\_\_\_ YEAR:- \_\_\_\_\_

BRANCH:- \_\_\_\_\_  
 CLASS:- \_\_\_\_\_  
 CAPTAIN'S NAME:- \_\_\_\_\_  
 Amount Received:- \_\_\_\_\_

  
**PRINCIPAL**  
 THEEM COLLEGE OF ENGINEERING  
 At Village Betegeat, Boisar Chitradistrict  
 Dist. Palghar (East) Tal. & Dist. Palghar - 405 101  
**(Student Coordinator)**





# JASHN-E-THEEM 2019

19

## ENTRY FORM

Athlon

9<sup>th</sup> Jan-14<sup>th</sup> Jan

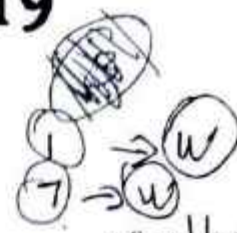

NAME OF THE EVENT:- Cricket  
 DEPARTMENT/ CLASS:- Mech (2nd year) (B)  
 CAPTAIN'S NAME:- Bicuwal

CONTACT NO:- 9769081750  
Medhaj Jashi

Sr.No.	Students Full name	Branch/Year	Signature
1	Medhaj Jashi	Mech	m.j.jashi
2	Zahid Patel	Mech	Zahid
3	Hitesh	Mech	Hitesh
4	Yash Chauri	Mech	Yash
5	<del>Yash</del> Ashutosh Raut	Mech	Ashutosh
6	Tanmay	Mech	Tanmay
7	Ashish	Mech	Ashish
8	Satish	Mech	Satish
9	Arsalan	Mech	Arsalan
10	Yash Bhagat	Mech	Yash
11	Atharva	Mech	Atharva
12	Nikhilesh	Mech	Nikhilesh
13	Ketan	Mech	Ketan
14	Brajwal	Mech	Brajwal
15	Apurva	Mech	Apurva
16	Aadharsh	Mech	Aadharsh

Note:- Without I.D. card students shall not be allowed to participate in the event

Principal Sign

THEEM COLLEGE OF ENGINEERING, BOISAR

TEAM

BRANCH:-  
 CLASS:-  
 CAPTAIN'S NAME:-  
 Amount Received:-

YEAR:-



*(Handwritten Signature)*

PRINCIPAL  
 THEEM COLLEGE OF ENGINEERING  
 Village Betagaon, Boisar Tal. & Dist. Palghar

(Student Coordinator)

# JASHN-E-THEEM 2019

ENTRY FORM

Athlon

9<sup>th</sup> Jan-14<sup>th</sup> Jan

(3) → (2)

NAME OF THE EVENT:- Cricket.  
DEPARTMENT/ CLASS:- FE-DIV-B  
CAPTAIN'S NAME:- Dhruvi Sancho

CONTACT NO:- 8007639783

Sr.No.	Students Full name	Branch/Year	Signature
1	Rathod Kisan	Electrical	<i>[Signature]</i>
2	Dhruvi Sancho	Comp	<i>[Signature]</i>
3	Avishkar Jadhav	Auto	<i>[Signature]</i>
4	Rajkumar K. Yadav	I.T	<i>[Signature]</i>
5	YOGENDRA R. SHARMA	IT/F.E.	<i>[Signature]</i>
6	Prasant Parashant S Paul	Mech/F.E.	<i>[Signature]</i>
7	Vikas Devendranath Prajapati	Mech/FE	<i>[Signature]</i>
8	Hrishikesh S. Sankhe	IT/FE	<i>[Signature]</i>
9	Jay. Velkar	Auto/FE	<i>[Signature]</i>
10	Bobby H. Pandey	Auto/FE	<i>[Signature]</i>
11	Manas Mankar	Mech/FE	<i>[Signature]</i>
12	Hussain A. Shaikh	Auto/FE	<i>[Signature]</i>
13			
14			
15			
16			

Note:- Without I.D. card students shall not be allowed to participate in the event

Principal Sign

THEEM COLLEGE OF ENGINEERING, BOISAR

TEAM

BRANCH:-  
CLASS:-  
CAPTAIN'S NAME:-  
Amount Received:-



YEAR:- F. E (B)

*[Signature]*  
PRINCIPAL

THEEM COLLEGE OF ENGINEERING  
At Village Beteegaon, Bolser Chitler Road,  
Boisar (East) Tal. & Dist. Palghar

(Student Coordinator)



# JASHN-E-THEEM 2019

## ENTRY FORM

*Athlon*

9<sup>th</sup> Jan-14<sup>th</sup> Jan

(2) → (W)

NAME OF THE EVENT:-  $\text{Cricket}$   
 DEPARTMENT/CLASS:- T.E. Automobile  
 CAPTAIN'S NAME:- Kaustubh . J . vinde .

CONTACT NO:- 7770094049

Sr.No.	Students Full name	Branch/Year	Signature
1	Kaustubh . J . vinde .	T.E. AUTO	<i>Kaustubh</i>
2	Prajat . V . Bore .	T.E. AUTO	<i>Prajat</i>
3	Kunal Patil	T.E. AUTO	<i>Kunal</i>
4	Karan Shetty .	T.E. AUTO	<i>Karan</i>
5	Sagar pawar .	TE. AUTO	<i>Sagar</i>
6	Dhanraj Naik	T.E. AUTO	<i>Dhanraj</i>
7	Gaurav Bore .	T.E. AUTO	<i>Gaurav</i>
8	Sagar singh	T.E. AUTO	<i>Sagar</i>
9	Saurabh raul	T.E. AUTO	<i>Saurabh</i>
10	AKshay Mundave .	T.E. AUTO	<i>AKshay</i>
11	Amit chaurhan .	T.E. AUTO	<i>Amit</i>
12	pranay pille .	T.E. AUTO	<i>pranay</i>
13	Krupesh shinde	T.E. AUTO	<i>Krupesh</i>
14	Dhruv waghela .	T.E. AUTO	<i>Dhruv</i>
15	Shreyal Gawade	T.E. AUTO	<i>Shreyal</i>
16	Sachin Pathak	T.E. AUTO	<i>Sachin</i>

Note:- Without I.D. card students shall not be allowed to participate in the event

Principal Sign



*[Signature]*

PRINCIPAL  
 THEEM COLLEGE OF ENGINEERING  
 At Village Borsar, Borsar Chitambar  
 Palghar (East) Tal. & Dist. Palghar - 401302



# JASHN-E-THEEM 2019

## ENTRY FORM

Athlon

9<sup>th</sup> Jan-14<sup>th</sup> Jan

CONTACT NO: 9284202441  
9769887299

NAME OF THE EVENT:- Cricket  
DEPARTMENT/ CLASS:- BE Electrical  
CAPTAIN'S NAME:- Handik Raut

Sr.No.	Students Full name	Branch/Year	Signature
1	Handik C. Raut	BE Elect	Handik Raut
2	Rajiv Nair		
3	X Harsh Darji		
4	X Jaymeen Chavda		
5	Niket Iseni		
6	Mandar Pahl		
7	Naik Thakur		
8	Saurabh Tandel		
9	Shubham Mahajan		
10	Akshay Chhadigaonkar		
11	Siddhesh Pangrekar		
12	Amey More		
13	Jay Rajput		
14	X Piyush Pahl		
15	Mujjatar Kaliya		
16	Meet Patel		

Note:- Without I.D. card students shall not be allowed to participate in the event

Principal Sign



PRINCIPAL  
THEEM COLLEGE OF ENGINEERING  
M. Village Betgaon, Boisar Chhitar Road  
Boisar (East) Tal. & Dist. Palanpur

# JASHN-E-THEEM 2019

ENTRY FORM

Athlon

9<sup>th</sup> Jan-14<sup>th</sup> Jan

3 → W

NAME OF THE EVENT:- Cricket  
DEPARTMENT/ CLASS:- T.E civil  
CAPTAIN'S NAME:- HARDIK RAUT

CONTACT NO:- 7507947764

Sr.No.	Students Full name	Branch/Year	Signature
1	Hardik Raut	T.E. civil	<i>[Signature]</i>
2	Siddhart Save	T.E civil	<i>[Signature]</i>
3	Chinmay Pimple	T.E civil	<i>[Signature]</i>
4	Ilyas Bhati	T.E civil	<i>[Signature]</i>
5	Ebad - Shaikh	T.E civil	<i>[Signature]</i>
6	Hitesh Jain	T.E civil	<i>[Signature]</i>
7	Satish Bhardwaj	T.E civil	<i>[Signature]</i>
8	Suraj yadav	T.E. civil	<i>[Signature]</i>
X 9	Pankaj kushwaha	T.E civil	<i>[Signature]</i>
10	Sachin Sukla	T.E civil	<i>[Signature]</i>
X 11	Vikas Kabar	T.E civil	<i>[Signature]</i>
X 12	Ibrahim khalifa	T.E civil	<i>[Signature]</i>
X 13	Kevin Guram	T.E civil	<i>[Signature]</i>
X 14	Nehal Gupta	T.E civil	<i>[Signature]</i>
15	Pranay. Gaikwad	T.E civil	<i>[Signature]</i>
16	<del>Alvina Katta</del> Alighay Yadav <del>Noween Katta</del>	T.E civil	<i>[Signature]</i>

Note:- Without I.D. card students shall not be allowed to participate in the event

Principal Sir



*[Signature]*

PRINCIPAL  
THEEM COLLEGE OF ENGINEERING  
St. Village Borsar, Borsar Chikar,  
Palghar (East) Tal. & Dist. Palghar



# JASHN-E-THEEM 2019

ENTRY FORM

Athlon

9<sup>th</sup> Jan-14<sup>th</sup> Jan

Final

16

(L) → (W)

NAME OF THE EVENT:- Cricket  
DEPARTMENT/ CLASS:- SE / Civil  
CAPTAIN'S NAME:- Hozef Shaikh

CONTACT NO:- 8698414533

Sr.No.	Students Full name	Branch/Year	Signature
✓ 1	Hozef Shaikh	Civil / SE	
✓ 2	Hritik Meher	Civil / SE	
✓ 3	Hashim Shaikh	Civil / SE	
✓ 4	Minar Raut	Civil / SE	
5	Mudassar Khan	Civil / SE	
✓ 6	Rugved Dichwalkar	Civil / SE	
7	Ishak Chaudhary	Civil / SE	
✓ 8	Arshad Shaikh	Civil / SE	
9	x Shashi Kanojiya	Civil / SE	
10	✓ Karthik Shukla	Civil / SE	
11	x Rizwan Qadri	Civil / SE	
12	✓ Ahamed Khan	Civil / SE	
13	Wasta Radeef	Civil / SE	
✓ 14	Kanojiya Shashi	Civil / SE	
✓ 15	Raj Savita	Civil / SE	
✓ 16	Darwish Md.	Civil / SE	

Note:- Without I.D. card students shall not be allowed to participate in the event

Principal Sign



*[Handwritten Signature]*

PRINCIPAL  
THEEM COLLEGE OF ENGINEERING  
Village Beteagan, Borsar Chitragarh  
Borsar (East) Tal. & Dist. Palahna



# JASHN-E-THEEM 2019

ENTRY FORM

Athlon

9<sup>th</sup> Jan-14<sup>th</sup> Jan

6

W

NAME OF THE EVENT:-

DEPARTMENT/ CLASS:-

CAPTAIN'S NAME:-

Third year Electrical Engg. (Degree) 7263 871960  
7467047451  
CONTACT NO:- 8140080784

Sr.No.	Students Full name	Branch/Year	Signature
1	Nichhal Dawame	T.E Elect.	Nichhal
2	Gauresh Kumbhar	T.E Elect.	GKumbhar
3	Prajyot Arekar	T.E Elect.	Arekar
4	Govind Patil	T.E Elect.	Patil
5	Suraj Pechhi	T.E Elect.	Suraj
6	Sagar Tore	T.E Elect.	Tore
7	MO. Tshaque	T.E Elect.	MO Tshaque
8	Chinmay Machchhi	T.E Elect.	Chinmay
9	Nitesh Dhodhi	T.E Elect.	Dhodhi
10	Parag Bhosale	T.E Elect.	Bhosale
11	AKash Pawar	T.E Elect.	Pawar
12	Arshad Sarathiya	T.E Elect.	Sarathiya
13	Bhawin Bhoir	T.E Elect.	Bhoir
14	Ahis Khalifa	T.E Elect.	Ahis
15			
16			

Note:- Without I.D. card students shall not be allowed to participate in the event

Principal Sign



*[Handwritten Signature]*

PRINCIPAL

THEEM COLLEGE OF ENGINEERING  
At Village Betgaon, Bolser Chikar Road,  
Sangli (East) Tal. & Dist. Palghar - 431 001

# JASHN-E-THEEM 2019

## ENTRY FORM

Athlon

9<sup>th</sup> Jan-14<sup>th</sup> Jan

6

W

NAME OF THE EVENT:-

DEPARTMENT/ CLASS:- Third year Electrical Engg. (Degree) 7263 871960  
7767047451

CAPTAIN'S NAME:- Gauresh Kumbhar

CONTACT NO:- 8140080784

Sr.No.	Students Full name	Branch/Year	Signature
1	Nikhil Dawane	T.E Elect.	N Dawane
2	Gauresh Kumbhar	T.E Elect.	G Kumbhar
3	Prayot Arekar	T.E Elect.	Prayot
4	Govind Patil	T.E Elect.	G Patil
5	Suraj Pechhi	T.E Elect.	Suraj
6	Sagar Tore	T.E Elect.	S Tore
7	MD. Ishaque	T.E Elect.	MD Ishaque
8	Chinmay Machchhi	T.E Elect.	Chinmay
9	Nitesh Dhodhi	T.E Elect.	N Dhodhi
10	Parag Bhasale	T.E Elect.	P Bhasale
11	AKash Pawar	T.E Elect.	A Pawar
12	Arshad Sorathiya	T.E Elect.	A Sorathiya
13	Bhawin Bhoir	T.E Elect.	B Bhoir
14	Anis Khalifa	T.E Elect.	A Khalifa
15			
16			

Note:- Without I.D. card students shall not be allowed to participate in the event

Principal Sign



*(Handwritten Signature)*

PRINCIPAL  
THEEM COLLEGE OF ENGINEERING  
St. Village Bilegaon, Boisar Tal. & Dist. Palghar



# JASHN-E-THEEM 2019

## ENTRY FORM

*Athlon*

9<sup>th</sup> Jan-14<sup>th</sup> Jan

(3) → (W)

NAME OF THE EVENT:- *cricket*  
 DEPARTMENT/CLASS:- *mechanical / S.Y.Mech (B)*  
 CAPTAIN'S NAME:- *shubham. chin*

CONTACT NO:- 7262823018

Sr.No.	Students Full name	Branch/Year	Signature
1 ✓	Taved Ali	ME- II <sup>nd</sup>	<i>Taved</i>
2 ✓	Pradum chauchan	ME- II <sup>nd</sup>	<i>Pradum</i>
3 ✓	shubham. C.S. Gizi	ME- II <sup>nd</sup>	<i>shubham</i>
4 ✓	Arsalan. shaikh	ME- II <sup>nd</sup>	<i>Arsalan</i>
5 ✓	Rohit. Pandey	ME- II <sup>nd</sup>	<i>Rohit</i>
6 ✓	vivek. Bhandwal	ME- II <sup>nd</sup>	<i>vivek</i>
7 ✓	Gulshan. Khan.	ME- II <sup>nd</sup>	<i>GKhan</i>
8 ✓	usman. pater	ME- II <sup>nd</sup>	<i>usman</i>
9 ✓	umar. shaikh	ME- II <sup>nd</sup>	<i>umar</i>
10 ✓	Sagar. Ghoshke	ME- II <sup>nd</sup>	<i>Sagar</i>
11	Satendra. yadav	ME- II <sup>nd</sup>	<i>Satendra</i>
12	Shykh. Abhishek Jeth. Pathi	ME- II <sup>nd</sup>	<i>Shykh</i>
13	vishwas. pathak.	ME- II <sup>nd</sup>	<i>vishwas</i>
14	vaibhav. Rasal	ME- II <sup>nd</sup>	<i>vaibhav</i>
15	loubik. More	ME- II <sup>nd</sup>	<i>loubik</i>
16	omkar khade.	ME- II <sup>nd</sup>	<i>omkar khade</i>

Note:- Without I.D. card students shall not be allowed to participate in the event

Principal Sign



*[Handwritten Signature]*

PRINCIPAL  
 THEEM COLLEGE OF ENGINEERING  
 At Village Betgaon, Borsar Chimer  
 Dist. Patkhar, ...



# JASHN-E-THEEM 2019

(2) → W

## ENTRY FORM

Athlon

9<sup>th</sup> Jan-14<sup>th</sup> Jan

NAME OF THE EVENT:-

DEPARTMENT/ CLASS:- Ty-meek - diploma

CAPTAIN'S NAME:- kunjai Raut

8208245997

8237952546

CONTACT NO:- 8668677495

Sr.No.	Students Full name	Branch/Year	Signature
* 1	Riyaz Thakur	meh -	Ajaz
2	✓ Sonil Shivhare	= 1 =	Sonil
3	✓ Karan Sawant	= 1 =	Karan
* 4	✓ Manas Pimple	= 1 =	Manas
* 5	✓ Mohit Raut	=	Mohit
* 6	✗ Nihar Patel	-	Nihar
7	✓ Dharam Ghant	-	Dharam
8	✓ kunjai Raut	-	Kunjai
9	✓ <del>Sukil Bari</del>	-	Sukil
10	✓ Arbai Shaikh	-	Arbai
11	✓ Asim Shaikh	-	Asim
12	✓ Amey Sankhe	-	Amey
13	✗ Nined Patil	-	Nined
14	✗ Ganesh Vante	-	Ganesh
15	✓ Sarvesh Rupate	-	Sarvesh
16	✓ Kairalya Kawali	- 1 -	Kairalya

Note:- Without I.D. card students shall not be allowed to participate in the event

Principal Sign



*(Handwritten Signature)*

PRINCIPAL  
THEEM COLLEGE OF ENGINEERING  
St. Village Bologan, Bolar Chikar  
Bolar (East), Tal. & Dist. Palghar

# JASHN-E-THEEM 2019

## ENTRY FORM

Athlon

9<sup>th</sup> Jan-14<sup>th</sup> Jan

(7) → (L)

NAME OF THE EVENT:- CRICKET

DEPARTMENT/ CLASS:- SE IT

CAPTAIN'S NAME:- Vishal Singh

8879878253

CONTACT NO:- 9004279415  
88 900 8879878253

Sr.No.	Students Full name	Branch/Year	Signature
1	Vishal Singh	SE IT	Vishal
2	Tejas Mahade Mahade	SE IT	Tejas
3	Shubham Dahi	SE IT	Shubham
4	Saad Khan	SE IT	Saad
5	Chirag Mande	SE IT	Chirag
6	Vaibhav Neman	SE IT	Vaibhav
7	Omkar Chatge	SE IT	Omkar
8	Tanmay Bose	SE IT	Tanmay
9	Rishi Rishi Vyas	SE IT	Rishi
10	Zaki Farooqui	SE IT	Zaki
11	Ketan Thakur	SE IT	Ketan
12	Omkar Agarwal	SE IT	Omkar
13	Shubham Patil	SE IT	Shubham
14	Rohan Kamble	SE IT	Rohan
15	Rohan Chavan	SE IT	Rohan
16	Aditya Nishant Nishant Aditya Nishant	SE IT	Aditya

Note:- Without I.D. card students shall not be allowed to participate in the event



Principal Sign

*(Signature)*

PRINCIPAL  
THEEM COLLEGE OF ENGINEERING  
St. Village Betagan, Bolser Chikar R.  
Palshir (East) Tal. & Dist. Palshir.



# JASHN-E-THEEM 2019

## ENTRY FORM

Athlon

9<sup>th</sup> Jan-14<sup>th</sup> Jan

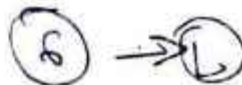

NAME OF THE EVENT:- CRICKET  
DEPARTMENT/CLASS:- ETRX/B.E  
CAPTAIN'S NAME:- Prerak Hegde

CONTACT NO:- 9545816219

Sr.No.	Students Full name	Branch/Year	Signature
1	Ranakumar Singh	B.E(ETRX)	
2	Gaurav Mishra	- 11 -	
3	Sunil Prujapati	- 11 -	
4	Viddhesh Gharat	- 11 -	
5	Moinuddin Khan	- 11 -	
6	Prashant Govind	- 11 -	
7	Sudhanshu Singh	- 11 -	
8	Prerak Hegde	- 11 -	
9	<del>Shreshth</del> Pradiwal Naik	B.E(Mech)	
10	Rahul Mishra	B.E(Mech)	
11	Neelkanth Thakur	B.E(Civil)	
12	Rathnam Umesh		
13	<del>Umesh</del> Rath Jay deep		
14			
15			
16			

Note:- Without I.D. card students shall not be allowed to participate in the event

Principal Sign



PRINCIPAL  
THEEM COLLEGE OF ENGINEERING  
At Village Betogoon, Boisar Chitradistrict  
Boisar (East) Tal. & Dist. Palghar



# JASHN-E-THEEM 2019

ENTRY FORM

*Athlon*

9<sup>th</sup> Jan-14<sup>th</sup> Jan

NAME OF THE EVENT:- Cricket  
 DEPARTMENT/CLASS:- B.E Mech A  
 CAPTAIN'S NAME:- Pawan Yadav

Prashant  
 9545553962  
 CONTACT NO:- 8600334566  
 8999203387

Sr.No.	Students Full name	Branch/Year	Signature
1	Pawan Yadav (C)		Pawan Yadav
2	Sadashiv sudke		Sudke
3	Nikhil shinde		Nshinde
4	Prashant Korda		
5	Arman sharkh		
6	Harshad Pagdhare		
7	Prachit Raut	B.E.	
8	Rizwan Khan	MECH	
9	Yakub Ansari		
10	Tanmay Murde		
11	Sunny Kadam		Sunny Kadam
12	Ajay Machi		
13	Rushikesh Pawar		
14	Vaibhav Sharma		
15	Vikrant Raut		
16	Mohsin		

Note:- Without I.D. card students shall not be allowed to participate in the event

Principal Sign



*(Handwritten Signature)*

PRINCIPAL  
 THEEM COLLEGE OF ENGINEERING  
 At Village Betegaon, Bolser Chittrur Dist.  
 (Near East Tal. & Dist. Palhar)

# JASHN-E-THEEM 2019

## ENTRY FORM

Athlon

9<sup>th</sup> Jan-14<sup>th</sup> Jan

NAME OF THE EVENT:- Over Arm cricket

DEPARTMENT/ CLASS:- B.E - AUTO

CAPTAIN'S NAME:- Sagar Gaikwad

4

2

CONTACT NO:- 8149412315

Sr.No.	Students Full name	Branch/Year	Signature
1	Sagar Gaikwad	B.E Auto	Sagar
2	Jignesh Patil	B.E Auto	Jignesh
3	Aditya Devsukhkar	B.E Auto	Aditya
4	Himesh Kale	B.E Auto	Himesh
5	Anne Vrushank	B.E Auto	Anne
6	Adwait Mirkar	B.E Auto	Adwait
7	Mayanesh Mestry	B.E Auto	Mayanesh
8	Vinay Sawant	B.E Auto	Vinay
9	Chetan Itkape	B.E Auto	Chetan
10	Ganvada	B.E Auto	Ganvada
11	Ansari Shebazz	B.E Auto	Ansari
12	Vaibhav Adarsh Singh	B.E Auto	Vaibhav
13	Grishh Padvekar	B.E Auto	Grishh
14	Faris Mehtalekar	B.E Auto	Faris
15	Vismay Raul Vaidya Markam	B.E Auto	Vismay
16	Umesh Patel	B.E Auto	Umesh

Note:- Without I.D. card students shall not be allowed to participate in the event

Principal Sign



*[Handwritten Signature]*

PRINCIPAL  
THEEM COLLEGE OF ENGINEERING  
At Village Betegeon, Boisar Tal. Palghar Dist. Palghar (East) Tal. & Dist. Palghar



# JASHN-E-THEEM 2019

ENTRY FORM

Athlon

9<sup>th</sup> Jan-14<sup>th</sup> Jan

Mob - 7506155602

NAME OF THE EVENT:- cricket  
DEPARTMENT/ CLASS:- TE-COMPS  
CAPTAIN'S NAME:- Prathamesh More

CONTACT NO:-

Sr.No.	Students Full name	Branch/Year	Signature
1	Prathamesh More	TE-COMPS	
2	Siddhesh Patil	- " -	
3	Shubham Dalvi	- " -	
4	Aashutosh Ghatge	- " -	
5	Chirayu Save	- " -	
6	<del>Md. Zakir</del> A. Talib	- " -	
7	Atik Khan	- " -	
8	Gaurav Kini	- " -	
9	Shavez Shaikh	- " -	
10	Shaibazh	- " -	
11	Siddhesh Salunkhe	- " -	
12	Sunil Patil	- " -	
13	Vaibhav Singh	- " -	
14	Shubham Naik	- " -	
15	Vikas B. Singh	- " -	
16			

Note:- Without I.D. card students shall not be allowed to participate in the event

Principal Sign



PRINCIPAL  
THEEM COLLEGE OF ENGINEERING  
St. Village Beteagan, Bolser Chikar P.  
Palhar (East Tal. & Dist. Palhar)



# JASHN-E-THEEM 2019

## ENTRY FORM

### Athlon

9<sup>th</sup> Jan-14<sup>th</sup> Jan

NAME OF THE EVENT:- cricket (open)  
 DEPARTMENT/CLASS:- T.E. mech (A)  
 CAPTAIN'S NAME:- Aniket Borre

2 → 9545812355  
 CONTACT NO:- 8788340588

Sr.No.	Students Full name	Branch/Year	Signature
1	Sakket. S. Kadam	TE mech(A)	
2	Utkarsh. P. Gharat	- - -	
3	chaitanya. S. Gharat	- - -	
4	Dhaval. Gharat	- - -	
5	Viraj. khandalgaonkar	- - -	
6	Rohit. katkar	- - -	
7	Lukman. mulla	- - -	
8	Amit	- - -	
9	Aniket. Borre		
10	Jiggesh		ABD
11	Akash. Ranpise		
12	Rakesh. Mishra		
13	Vidit Sankhe		
14	Vincent Sankhe		
15	Khan Abdulmatin		
16	Rajan Pandey		

Note:- Without I.D. card students shall not be allowed to participate in the event

Principal Sign



*(Handwritten Signature)*

PRINCIPAL  
 THEEM COLLEGE OF ENGINEERING  
 St. Village Beteagan, Borsar Chikar P.  
 Dist. East Tal. & Dist. Palghar

## Athlon 2019 List of the Student Coordinator

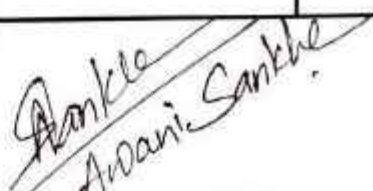
Event Name :	Base cricket (Girls)		
Sr.no	Full Name(Should be in Capital letter)	Branch	Year
1	SHWETA PAWAR.	Electrical	SE
2	MITALI PARMAR	—————	SE
3	NIDHI BHARATI	—————	SE
4			
5			
6			
7			
8			
9			
10			
11			
12			
13			
14			
15			
Fees Collection	Number of Teams:		
	Fees/Team		
	Total Amount:		
			
		Sign and Name of Event Coordinator	



  
**PRINCIPAL**  
 THEEM COLLEGE OF ENGINEERING  
 41 Village Bolegaon, Bolar Chittrur Road,  
 Bosar (East) Tal. & Dist. Pimpri - 411004

## Athlon 2019 List of the Student Coordinator

Event Name :

Badminton 2019

Sr.no

Full Name(Should be in Capital letter)

Branch

Year

1	Santosh .S. Pandey	TE Automobile	2018-19
2	Kanjiza Shashi Kumar Jothan prasad	S.E civil	2018-19
3	Sagar <sup>bhavsar</sup> <del>bhavsagar</del>	TE IT	2018-19
4	Shubham more	Dip. Mech	2018-19
5	shreyas Baflekar.	TE I.T	2018-19
6	Nidhi chechan	T.E.I.T	2018-19
7	Riddhi Rathod	T.E. Civil	2018-19
8			
9			
10			
11			
12			
13			
14			
15			

Fees Collection

Number of Teams:

30

Fees/Team

20

Total Amount:

600

Rajat Singh

Sign and Name of Event Coordinator



  
**PRINCIPAL**  
 THEEM COLLEGE OF ENGINEERING  
 12, Village Borsari, Borsari Chhatra P.  
 Borsari (East) Tal. & Dist. Palanpur



## Athlon 2019 List of the Student Coordinator

Event Name :	FOOTBALL		
Sr.no	Full Name(Should be in Capital letter)	Branch	Year
1	MEET MISTRY	MECH	BE
2	AASHUTOSH KAMBLI	MECH	BE
3	PRAANAV NAIR	ELECTRICAL	BE
4	VISO JOY	ELECTRICAL	SE
5	AMIN M.	MECH	BE
6	QUADIR KHAN	COMP.	BE
7			
8			
9			
10			
11			
12			
13			
14			
15			
Fees Collection	Number of Teams:	06	
	Fees/Team	150	
	Total Amount:	900	500
			
		Sign and Name of Event Coordinator	



  
**PRINCIPAL**  
 THEEM COLLEGE OF ENGINEERING & TECHNOLOGY  
 At: Village Bheegao, Bheer Chikar Rd.  
 Near (East) Tal. & Dist. Palghar.



## Athlon 2019 List of the Student Coordinator

Event Name :	CARROM		
Sr.no	Full Name(Should be in Capital letter)	Branch	Year
1	Shaikh Hashim Mohd. Saeed	CIVIL	SE
2	SHAIKH HAZEF ZAFHURMEYA	CIVIL	SE
3	KRUSHITA MAHESH AMBHORE	ELECTRICAL	SE
4	JAJEE KIRAN PATIL	ELECTRICAL	SE
5	MARSHAD ANIL PARAB	MECHANICAL	SE
6	VIJO JOY	ELECTRICAL	SE
7	PRITESH GANESH PATEL	IT	SE
8	KAIVALYA JYOTESH SAWANT	AUTO	SE
9			
10			
11			
12			
13			
14			
15			
Fees Collection	Number of Teams:	48	
	Fees/Team	10	
	Total Amount:	480/-	
		 Prabhakar Manjari	
		Sign and Name of Event Coordinator	



**PRINCIPAL**  
 THEEM COLLEGE OF ENGINEERING  
 At. Village Betegaoon, Boisar Chittrur  
 Talisar (East) Tal. & Dist. Palghar



## Athlon 2019 List of the Student Coordinator

Event Name:	NEON CRICKET		
Sr.no	Full Name(Should be in Capital letter)	Branch	Year
1	ANSAR AHMED	} SE COMPUTER	
2	HASIM PATHAN		
3	IRSHAD MANSURI		
4	SANDEEP JAISWAR		
5	ASHUTOSH MISHRA		
6	TALIB ANSARI		
7	VIVEK GUPTA		
8	SACHIN SINGH		
9	SUNNY GUPTA		
10	HEMANT SHETTY		
11			
12			
13			
14			
15			
Fees Collection	B G Number of Teams: $25 + 09 = 34$		
	Fees/Team 70/-		
	Total Amount: 2380		
		Ashraf Siddiqui  Sign and Name of Event Coordinator	

  
**PRINCIPAL**  
 THEEM COLLEGE OF ENGINEERING  
 Village Bolegaon, Bolar Chitauri P.O.  
 Bolar (East) Tal. & Dist. Patkhera, B.P.



## Athlon 2019 List of the Student Coordinator

Event Name :			
Sr.no	Full Name (Should be in Capital letter)	Branch	Year
1	ANKIT YADAV	IT	T.E
Blind	2 KAJAL SANKHE . S	IT	T.E
Hit	3 SHREYA PATIL	IT	T.E
man	4 KAJAL H SANKE	IT	T.E
5			
6			
Blind	7 SHUBHAM MISHRA	IT	T.E
Fold	8 NIMESH MORE	IT	SE
	9 BHAVIKA GODE	IT	SE
	10 ANCHAL TEWARI	IT	SE
11			
12			
13			
14	Blind Hitman		
15	Blind fold		
Fees Collection	Number of Teams:	Hitman 22	Fold 20
	Fees/Team	20	10
	Total Amount:		440
			200
			640
		 Khali Pinjari	
		Sign and Name of Event Coordinator Kh 	

PRINCIPAL  
 THEEM COLLEGE OF ENGINEERING  
 Village Bhopan, Boisar, Taluka  
 Dist. (East) Tal. & Dist. Palghar

## Athlon 2019 List of the Student Coordinator

Event Name: **ATHLETIC (Girls) (Shotput, Discus, Javelin, Running)**

Sr.no	Full Name(Should be in Capital letter)	Branch	Year
1	FURKAN SHAIKH	I.T	TE
2	SHUBHAM MISHRA	I.T	TE
3	NIMESH MORE	I.T	SE
4			
5			
6			
7			
8			
9			
10			
11			
12			
13			
14			
15			
<b>Fees Collection</b>	Number of Teams:	—	—
	Fees/Team	—	—
	Total Amount:	—	—
		<p style="font-size: 1.2em;"><i>Surakha Attarde</i></p> <p><b>Surakha Attarde</b></p>	
<b>Sign and Name of Event Coordinator</b>			

  
**PRINCIPAL**  
 THEEM COLLEGE OF ENGINEERING  
 St. Village Betgaon, Bolar Chitthar  
 Bolar (East) Tal. & Dist. Palghar



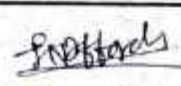

## Athlon 2019 List of the Student Coordinator

Event Name :	Throw ball (Girls)		
Sr.no	Full Name(Should be in Capital letter)	Branch	Year
1	Akshay P Sawal		
2	Furkan		
3	AKSHAY P SAWAL	Elect	
4	FURKAN SHAIKH	I.T	TE
5	SHUBHAM MISHRA	I.T	TE
6	ANKIT YADAV	I.T	TE
7	TRAM GAWANDI	CIVIL	TE
8			
9			
10			
11			
12			
13			
14			
15			
Fees Collection	Number of Teams:	_____	_____
	Fees/Team	_____	_____
	Total Amount:	_____	_____
		 Surekha Attarde	
		Sign and Name of Event Coordinator	



  
**PRINCIPAL**  
 THEEM COLLEGE OF ENGINEERING  
 St. Village Bargaon, Bosar Chikar  
 Bosar (East) Tal. & Dist. Palghar

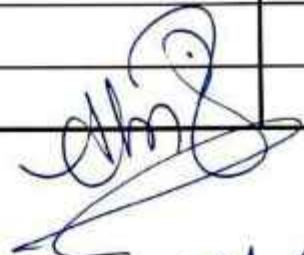

Athlon 2019 List of the Student Coordinator			
Event Name :	Cricket ( <del>Box</del> )		
Sr.no	Full Name(Should be in Capital letter)	Branch	Year
1	SHUBHAM BHANDARI	CIVIL	BE
2	SHAIKH EBAD		T.E
3	HITESH JAIN		T.E
4	AKSHAY SAWAL	ELEC.	S.E
5	AHMAD HAMID	& CIVIL	B.E
6	AMARDEEP SINGH	ELEC.	S.E
7	VIRAJ RAUT		S.E
8	KRUPESH SHINDE	<del>MECH.</del> AUTO	T.E
9	MANIYAR SHAMIM	MECH.	F.E (A)
10	NACHAN ZAINUL		F.Y
11	JOSHIL BARI.		F.Y
12	DURGESH RAUT.	ELEC.	S.E
13			
14			
15			
Fees Collection	Number of Teams:	21	
	Fees/Team	150	
	Total Amount:	3150	
		$3150 - 435 = 2715/-$	
		 Bagwan Md. Ayaz.	
		Sign and Name of Event Coordinator	



  
 PRINCIPAL  
 THEEM COLLEGE OF ENGINEERING  
 at Village Belagaon, Boisar Chikar Tal.  
 Boisar (East) Tal. & Dist. Patehar.

## Athlon 2019 List of the Student Coordinator

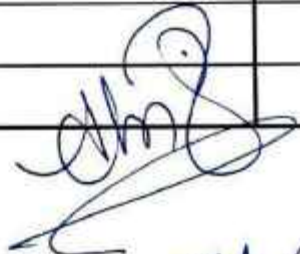
Athlon 2019 List of the Student Coordinator			
Event Name :	Cricket ( <del>Box</del> )		
Sr.no	Full Name(Should be in Capital letter)	Branch	Year
1	SHUBHAM BHANDARI	CIVIL	BE
2	SHAIKH EBAD	<u>          </u>	T.E
3	HITESH JAIN	<u>          </u>	T.E
4	AKSHAY SAWAL	ELEC.	S.E
5	AHMAD HAMID	& CIVIL	B.E
6	AMARDEEP SINGH	ELEC.	S.E
7	VIRAJ RAUT	<u>          </u>	S.E
8	KRUPESH SHINDE	<del>MECH</del> AUTO	T.E
9	MANIYAR SHAMIM	MECH.	F.E (A)
10	NACHAN ZAINUL	<u>          </u>	F.Y
11	JOSHIL BARI.	<u>          </u>	F.Y
12	DURGESH RAUT.	ELEC.	S.E
13			
14			
15			
Fees Collection	Number of Teams:	21	
	Fees/Team	150	
	Total Amount:	3150	
		3150 - 435 = 2715/-	
		 Bagwan Md. Ayaz.	
		Sign and Name of Event Coordinator	



PRINCIPAL  
 THEEM COLLEGE OF ENGINEERING  
 At Village Beteagan, Boisar Chitrad District  
 Boisar (East) Tal. & Dist. Palghar - 407 502

## Athlon 2019 List of the Student Coordinator

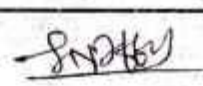

Event Name :	KHO - KHO (Girls)		
Sr.no	Full Name(Should be in Capital letter)	Branch	Year
1	APEKSHA NALWADE	Comp	TE
2	FURKAN SHAIKH	I.T	TE
3	SHUBHAM MISHRA	I.T	TE
4	NIMESH MORE	I.T	SE
5	KOHNIT SAINT	Mech	SE
6			
7			
8			
9			
10			
11			
12			
13			
14			
15			
Fees Collection	Number of Teams:	No ENTRY Fee	—
	Fees/Team	—	—
	Total Amount:	—	—
			 Surekha Attarde
			Sign and Name of Event Coordinator



**PRINCIPAL**  
 THEEM COLLEGE OF ENGINEERING  
 At Village Beteagan, Bolar Chikhar  
 Bolpur (East) Tal. & Dist. Palehar



## Athlon 2019 List of the Student Coordinator

Event Name :	Box Cricket		
Sr.no	Full Name(Should be in Capital letter)	Branch	Year
✓ 1	Hardik Raut	Electrical	BE
2	Rajiv Nair		BE
3	Saayabh Tandel		BE
4	Meetkumar Patel		BE
5	Amey More		BE
✓ 6	Mayur Gujar		TE
7	Siddhesh Pangrekar		BE
8	Nikhil Keni		TE
9	Gauresh Kumbhar		TE
10	Piyush Patil		BE
11	Siddhant Mahindrakar		BE
12	Shubham Mahajan		BE
13	Harsh Darji		BE
14	Akash Bharti		BE
15	Mandar Patil		BE
Fees Collection	Number of Teams:	23	
	Fees/Team	100 Per team	
	Total Amount:	2300	
	 PRINCIPAL THEEM COLLEGE OF ENGINEERING St. Village Betgaon, Bolser Chikar Jalgaon East, Tal. & Dist. Palit	 Rakesh S. Kushwah	
		Sign and Name of Event Coordinator	

- ✓ 16) Tanmay Santhale      Electrical      BE
- ✓ 17) Hardik Raut      Civil      TE
- ✓ 18) Prashant Korda      Mechanical      BE
- ✓ 19) Kartik Kanojia      ExTC      BE
- ✓ 20) Ankitkumar Singh      Electrical      BE

## Athlon 2019 List of the Student Coordinator

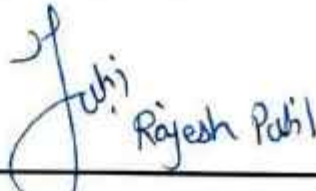
Event Name :	VOLLEYBALL		
Sr.no	Full Name(Should be in Capital letter)	Branch	Year
1	CHINMAY R. PIMPLE	CIVIL	TE
2	MANAS H. PIMPLE	MECH	TY
3	SOHIL BARI	MECH	TY
4	DHARAM GHARAJ	MECH	TY
5	SURAJ YADAV	CIVIL	TE
6	PIYUSH P. PATIL	ELEC.	BE
7	/		
8			
9			
10			
11			
12			
13			
14			
15			
Fees Collection	Number of Teams: 16		
	Fees/Team 50/-		
	Total Amount: 800/-		
	 Sign and Name of Event Coordinator		



  
**PRINCIPAL**  
 THEEM COLLEGE OF ENGINEERING,  
 At. Village Betegaon, Borsar Chikher  
 Borsar (East) Tal. & Dist. Patkhar.

Tejal Raut

### Athlon 2019 List of the Student Coordinator

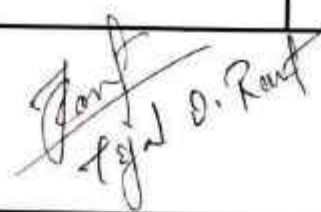

Athlon 2019 List of the Student Coordinator			
Event Name :	kcho kcho Cioo-		
Sr.no	Full Name(Should be in Capital letter)	Branch	Year
1	Kohini M. Jaini	Meehameical Enng	S-E.(1A)
2	Apeksh Nalawadekar.	Computer Enngg.	T.E.
3			
4			
5			
6			
7			
8			
9			
10			
11			
12			
13			
14			
15			
Fees Collection	Number of Teams:		
	Fees/Team		
	Total Amount:		
		 Tejal D. Raut	
		Sign and Name of Event Coordinator	



  
**PRINCIPAL**  
 THE M COLLEGE OF ENGINEERING  
 At. Village Beteagan, Boisar Chimer R-  
 Boisar (East) Tal. & Dist. Palghar - 40

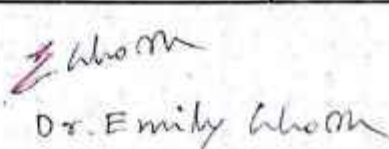

## Athlon 2019 List of the Student Coordinator

Event Name :	CHESS		
Sr.no	Full Name(Should be in Capital letter)	Branch	Year
1	Krushita M. AMBIRE	Electrical	S-E
2	JAIFE K. PATIL	"	S-E
3	ABDULLA ISBAL MEMON	"	S-E
4	ABHINAV DINESH HUSHEA	Computer	S-E
5			
6			
7			
8			
9			
10			
11			
12			
13			
14			
15			
Fees Collection	Number of Teams:		
	Fees/Team		
	Total Amount:		
		 Dr. Emily Whom	
			

Sign and Name of Event Coordinator

  
**PRINCIPAL**  
 THEEM COLLEGE OF ENGINEERING  
 At Village Betegaon, Boisar Chhitar Road  
 Boisar (East) Tal. & Dist. Palghar

## Athlon 2019 List of the Student Coordinator

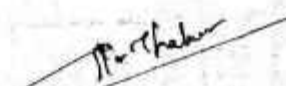
Event Name :	Tug of War		
Sr.no	Full Name(Should be in Capital letter)	Branch	Year
1	ANSARI MOHD. TALIB	Computer	S.E
2	ADITYA HINUKALE	Automobile.	S.E.
3	DURGA BHOJ	Civil	T.E.
4	IRAM GAWANDI	Civil	B.F.
5	VIVEK GUPTA	Computer	S.E
6	<del>Akash Singh</del>	<del>Automobile</del>	<del>S.E</del>
7	Ashish Singh		
8			
9			
10			
11			
12			
13			
14			
15			
Fees Collection	Number of Teams:	16 Boys team 8 girls team	
	Fees/Team	50/- Rs. for Boys only per team.	
	Total Amount:	800/- Rs	
		 Tejendra Thakur	
	Sign and Name of Event Coordinator		



**PRINCIPAL**  
 THEEM COLLEGE OF ENGINEERING  
 At Village Bolegaon, Borsar Chittel P.  
 Borsar (East) Tal. & Dist. Palahar

## Athlon 2019 List of the Student Coordinator

Athlon 2019 List of the Student Coordinator			
Event Name :	Kabaddi (		
Sr.no	Full Name(Should be in Capital letter)	Branch	Year
1	Kinnali Patil	Computer	III <sup>rd</sup> TE
2	Tram Gavande	Civil	B.E
3	Samiksha Patil	civil	TE
4	Chavri Patil	Civil	TE
5	Manish Kumar Yadav		
6	Atik Khan.	Computer	TE
7			
8			
9			
10			
11			
12			
13			
14			
15			
Fees Collection	Number of Teams:		
	Fees/Team		
	Total Amount:		
		Sign and Name of Event Coordinator	



PRINCIPAL  
THEEM COLLEGE OF ENGINEERING  
St. Village Betegeon, Borsar Chitkar (E)  
Borsar (East) Tal. & Dist. Palohar.

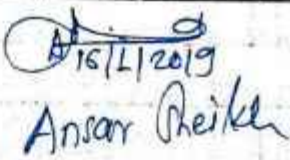

## Athlon 2019 List of the Student Coordinator

Event Name :	Athletics (Boys) [shot put, Discuss, Javelin, Running]		
Sr.no	Full Name(Should be in Capital letter)	Branch	Year
1	SHUBHAM BHANDARI	B: Civil	B.E
2	FURKAN SHAIKH	I: Computer	T.E
3			
4			
5			
6			
7			
8			
9			
10			
11			
12			
13			
14			
15			
Fees Collection	Number of Teams:		
	Fees/Team		
	Total Amount: 910		
		 16/11/2019 Ansar Sheikh	
		Sign and Name of Event Coordinator	



  
**PRINCIPAL**  
 THEEM COLLEGE OF ENGINEERING  
 At Village Belgaon, Belsar Chikher Road,  
 Palshikar (East) Tal. & Dist. Palshikar

H. J. Thim Trust's  
**Theem College of Engineering, Boisar**  
 Approved by AICTE (New Delhi), Government of Maharashtra and DTE  
 Affiliated to University of Mumbai

**Jashn-E-Theem 2K19**

Sr. No	Events Name	Sr. No	Students Coordinator	Branch	Year	Students Coordinator Mobile Number	Staff Co-ordinator Sigh.
1	1. Traditional + Rose day	1	Shruti Lade	Comp	TY	9503506481	
		2	Vishal Thakur	Comp	TY	7507058561	
		3	Pradnya Patil	Comp	TY	9763600668	
2	2. Retro+Chocolat e day	4	Shruti Lade	Comp	TY	9503506481	
		5	Pradnya Patil	Comp	TY	9763600668	
		6	Humera Gilani	Comp	TE	8446665513	
3	3. Mismatch Day	7	Humera Gilani	Comp	TE	8446665513	
		8	Sayali Mhatre	Comp	TY	9503506481	
		9	Vishal Thakur	Comp	TY	7507058561	
4	4. Saree/Formal day	10	Duhita Raut	Comp	SE	8605564295	
		11	Raj Savita	Civil	SE	703866373	
5	Mehndi (competition)	12	Humera Gilani	Comp	TE	8446665513	
		13	Shaikh Jannat	Comp	SY	7378626827	
		14	Manasi Gharat	Comp	SY	7397903247	
6	Best out of Waste	15	Huzefa Bag	IT	TE	8097319851	
		16	Sagar Yadav	Mech	TE	8268667849	
		17	Shweta Patil	IT	TE	9137659452	
7	Poster Painting	18	Rushikesh Shinde	Auto	FE	9527520002	
		19	Mohammad Umar	Civil	TY	9975612359	
		20	Rajan Vishwakarma	Civil	TY	869401322	
		21	Manasi Gharat -	Comp	SY	7397903247	
		22	Shaikh Jannat	Comp	SY	7378626827	
8	Rangoli	23	Simran Patil	IT	SE	8552065374	
		24	Archana Patil	IT	SE	965713359	
		25	Anchal Tiwari	IT	SE	8923314252	
9	Floral Decoration	26	Shaikh Arsalan	Mech	SE	7972240210	
		27	Barish Dindayal	Mech	SE	7040090760	
10	Singing	28	Jaydeep Shiyara	EXTC	BE	7798296623	
		29	Raj Savita	Civil	SE	8208217957	
		30	Pal Sachin	Mech	TY	8600655461	
11	Drama	31	Umar Khan	Civil	TY	9975612359	
		32	Saurabh Gharat	Civil	TY	9823370854	
		33	Santosh S. pandey	Auto	TE	7977286873	
		34	Akash Jadhav	Auto	SE	9370162488	
		35	Kaivalya Sawant	Auto	SE	8779865745	
		36	Shweta Pawar	Electrical	SE	9673373718	
12	Dance	37	Kapil J. Rathod	Civil	SE	7021228525	
		38	Sachin Singh	Comp	SE	7387444773	
		39	Sunny Gupta	Comp	SE	7276666761	
		40	Mohit Pandey	Comp	TY	8850464760	
		41	Krishna Bari	Comp	TY	9112102163	

Cultural Coordinator  
 Anwar Ahmad Shaikh



PRINCIPAL  
 THEEM COLLEGE OF ENGINEERING  
 At Village Betegaon, Boisar Taluka Boisar  
 District Palghar (East) Tal & Dist. Palghar



H. J. Thim Trust's  
**Theem College of Engineering, Boisar**  
 Approved by AICTE (New Delhi), Government of Maharashtra and DTE  
 Affiliated to University of Mumbai

**Jashn-E-Theem 2K19**

Sr. No	Events Name	Sr. No	Students Coordinator	Branch	Year	Students Coordinator Mobile Number	Staff Co-ordinator Sigh.
1	1. Traditional + Rose day	1	Shruti Lade ✓	Comp	TY	9503506481	
		2	Vishal Thakur ✓	Comp	TY	7507058561	
		3	Pradnya Patil ✓	Comp	TY	9763600668	
2	2. Retro+Chocolate day	4	Shruti Lade ✓	Comp	TY	9503506481	
		5	Pradnya Patil ✓	Comp	TY	9763600668	
		6	Humera Gilani ✓	Comp	TE	8446665513	
3	3. Mismatch Day	7	Humera Gilani ✓	Comp	TE	8446665513	
		8	Sayali Mhatre ✓	Comp	TY	9503506481	
		9	Vishal Thakur ✓	Comp	TY	7507058561	
4	4. Saree/Formal day	10	Duhita Raut ✓	Comp	SE	8605564295	
		11	Raj Savita ✓	Civil	SE	7036686373	
5	Mehndi (competition)	12	Humera Gilani ✓	Comp	TE	8446665513	
		13	Shaikh Jannat ✓	Comp	SY	7378626827	
		14	Manasi Gharat ✓	Comp	SY	7397903247	
6	Best out of Waste	15	Huzefa Baig ✓	IT	TE	8097319851	
		16	Sagar Yadav ✓	Mech	TE	8268667849	
		17	Shweta Patil ✓	IT	TE	9137659452	
7	Poster Painting	18	Rushikesh Shinde ✓	Auto	FE	9527520002	
		19	Mohammad Umar ✓	Civil	TY	9975612359	
		20	Rajan Vishwakarma ✓	Civil	TY	8698401322	
		21	Mansi Gharat ✓	Comp	SY	7397903247	
		22	Shaikh Jannat ✓	Comp	SY	7378626827	
8	Rangoli	23	Simran Patil ✓	IT	SE	8552065374	
		24	Archana Patil ✓	IT	SE	965713359	
		25	Anchal Tiwan ✓	IT	SE	9923314252	
9	Floral Decoration	26	Shaikh Arsalan ✓	Mech	SE	7972240210	
		27	Barishi Dindayal ✓	Mech	SE	7040090760	
10	Singing	28	Jaydeep Shiyara ✓	EXTC	BE	7798296823	
		29	Raj Savita ✓	Civil	SE	8208217957	
		30	Pal Sechin ✓	Mech	TY	8600055461	
11	Drama	31	Umar Khan ✓	Civil	TY	9975612359	
		32	Saurabh Gharat ✓	Civil	TY	9823370854	
		33	Santosh S. pandey ✓	Auto	TE	7977286873	
		34	Akash Jadhav ✓	Auto	SE	9370162486	
		35	Kaivalya Sawant ✓	Auto	SE	8779665745	
		36	Shweta Pawar ✓	Electrical	SE	9673373718	
12	Dance	37	Kapil J. Rathod ✓	Civil	SE	7021226525	
		38	Sechin Singh ✓	Comp	SE	7387444773	
		39	Sunny Gupta ✓	Comp	SE	7276066761	
		40	Mohit Pandey ✓	Comp	TY	8850464760	
		41	Krishna Bari ✓	Comp	TY	9112102163	

Krishma Bari

Cultural Coordinator  
 Ansar Ahmad Shaikh



*(Signature)*

**PRINCIPAL**  
 THEEM COLLEGE OF ENGINEERING  
 4<sup>th</sup> Village Belgaon, Boisar Chikar Road  
 Boisar (East Tal. & Dist. Palghar - 401 201)

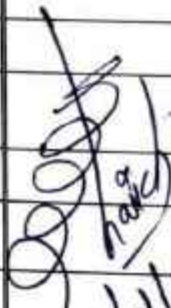

File Doc. Seq. No	Event/Document	1 Dance			
		Schedule Date	Submitted Date	Remark	Cultural Coord. Sign
1	Faculty Coord.	26/12/2018			
2	Student Coord	29/12/2018			
3	Meeting 0 agenda + Meeting Circular	29/12/2018			
4	Work Distribution	29/12/2018			
5	Requirment	29/12/2018			
6	Judges Requirement	29/12/2018			
7	Evaluation Sheet	10/01/2019			
8	Evaluation Parameter	10/01/2019			
9	Poster & Phamplet	10/01/2019			
10	Participant List	11/01/2019			
11	Judges Invitation	14/01/2019			
12	Execution Seq.	14/01/2019			
13	Final Winner List	18/01/2019			
14	Closure Report [1]	21/01/19			
15	Expenditure Bills	21/01/2019			
16	Observation & Remedy	21/01/2019			
17	Photo of the Event	21/01/2019			

  
 18/01/19



  
**PRINCIPAL**  
 THEEM COLLEGE OF ENGINEERING  
 At Village Bolegaon, Boisar Taluk Palnhar Dist. Palnhar - 31

H. J. Thim Trust's  
**Theem College of Engineering, Boisar**  
 Approved by AICTE (New Delhi), Government of Maharashtra and DTE  
 Affiliated to University of Mumbai

**Jashn-E-Theem 2K19**

Sr. No	Events Name	Staff Coordinator	Staff Coordinator Mobile Number	Total Expense	Entry Fees	No. of Participants	Amount
1	1.Traditional + Rose day	Prof. Awani Sankhe	7710023368	None	0	-	0
	2.Retro+Chocolate day						
	3.Mismatch Day	Prof. Sanketi Raut	7756032877				
	4.Saree/Formal day	Prof. Tejas Thakur					
2	Mehndi	Prof. Tasneem Azam	8007273375	None	0	-	0
		Sayali Mahajan	7385097722				
		Prof. Ruchi Rahi	7983904370				
3	Best out of Waste	Prof. Azhar Nabi	826850316	None	20	10	200
		Prof. Kalamuddin Ansari	8789267489				
		Prof. Vinay Sahu	8655848549				
4	Poster Painting	Prof. Kazi Azimuddin	9579850730	None	20	17	340
		Prof. S. Reddy	7588434855				
5	Singing	Prof. Zulfqar	9923510075	None	20	16	320
		Prof. shoib Khan	9768219633				
		Prof. Jayshree Sali	9284996588				
6	Mimicry	Prof. Nitin Sali	9503088306	None	0	-	0
		Prof. Mushtaque	8369899145				
7	Dance	Prof. Faiz Khan	9175306697	None	20	18	360
		Prof. Snehal Pawde	8149585212				
		Prof. Priyanka Dhande	9156867201				
8	Rangoli	Prof. Rosy Bhoi	9766160629	None	0	-	0
		Prof. Ruchi Rahi	7983904370				
		Mrunali Kokate	7709141560				
9	Floral Decoration	Prof. Tejal Raut	9960413634	None	0	-	0
		Tanvi Raut	9029840796				
10	Drama	Prof. Arbiya Shaikh	7020203625	400	0	-	0
		Prof. Geetha Yadur	7038825862				
		Prof. Shakir Hussain	9579105036				
<b>Total</b>				<b>400</b>	<b>-</b>	<b>61</b>	<b>1220</b>

Cultural Coordinator

Ansar Ahmad Shaikh

Account Officer

Mohd. Jafrulla Khan Kayani

PRINCIPAL

THEEM COLLEGE OF ENGINEERING  
 Village Belgaon, Boisar Chhattrpada  
 Dist. (East) Tal. & Dist. Palghar

Re

H. J. Thim Trust's  
**Theem College of Engineering, Boisar**  
 Approved by AICTE (New Delhi), Government of Maharashtra and DTE  
 Affiliated to University of Mumbai

**Jashn-E-Theem 2K19**

Sr. No	Participant/Rep. Name	Contact No.	Song/Theme	Time
<b>SINGING</b>				
1	Saurabh Gharat	9823370854	Tere Naam	4:15:00 PM ONWARDS
2	Shubham Patil	7066853982	Jaaye na Jaayena	
3	Ajay Shirke	8169178869	Aayat	
4	Pariksha Pimple	7738354517	Baba	
5	Rakhi Jha	9545750834	moh moh k dhage	
6	Washi Shah	9271447791	Dolna	
7	Vinit Pujari	9823818738	Laa Ishq/Dil diya galla	
8	Jaydeep	7798296623	Chunar	
9	Shahinshah	8624878635	RAP	
<b>SPORTS PRIZE DISTRIBUTION</b>				
10	<b>DRAMA (Effect of Social Media on youth)</b>			
<b>DANCE</b>				
11	Aniket & Bhavesh	9082447082	Koli Song	Group
12	Sona Yadav	7738667217	Diwani Mastani	Solo
13	Sakshi Singh	7507978218	Aafreen	Solo
14	Vividh Tare	9209223512	Simbha	Solo
15	Apeksha Nalwade	8788453566	Tribute to Madhuri	Solo
17	Rajshree Pachpande	7448015503	Sun Sathiya	Solo
18	Aniket & Reena	90822447082	Tujhe Reshmi Kale Baal	Group
19	Kapil Rathod	7021226525	Mix Song	Group
20	Bhavna Singh	8208267765	Tribute to Madhuri	Solo
21	<b>DRAMA (Girls Education)</b>			
<b>SINGING &amp; DANCE PRIZE DISTRIBUTION</b>				
Cultural Coordinator <div style="text-align: center;">                       Anzar Akhbar Shaikh                      Assistant Professor - Dept. of IT                 </div>				



**PRINCIPAL**  
 THEEM COLLEGE OF ENGINEERING  
 At Village Behgaon, Boisar, District Palghar  
 Tal. (East) Tal. & Dist. Palghar



H. J. Thim Trust's  
**Theem College of Engineering, Boisar**  
 Approved by AICTE (New Delhi), Government of Maharashtra and DTE  
 Affiliated to University of Mumbai

Cultural Night Approx Time

Event	Type	No. of Performances	Approx. Time	Total Time
Singing	Solo	9	6	54
Dance	Solo	6	5	30
	Group	3	7	21
Drama	Group	2	12	24
Total Time				2.15

Cultural Coordinator

Ansar Ahamad Shaikh

Principal

Dr. Aqueel Shah



**PRINCIPAL**  
 THEEM COLLEGE OF ENGINEERING  
 At Village Biregaon, Boisar Chitaval Road,  
 Boisar (East) Tal. & Dist. Palghar - 401 202

H. J. Thim Trust's  
**Theem College of Engineering, Boisar**  
 Approved by AICTE (New Delhi), Government of Maharashtra and DTE  
 Affiliated to University of Mumbai

**Jashn-E-Theem 2K19**

Sr. No	Events Name	Students Coordinator	Branch	Year	Students Coordinator Mobile Number
1	1.Traditional + Rose day	Shruti Lade	Comp	TY	9503506481
		Vishal Thakur	Comp	TY	7507058561
		Pradnya Patil	Comp	TY	9763600668
2	2. Retro+Chocolate day	Shruti Lade	Comp	TY	9503506481
		Pradnya Patil	Comp	TY	9763600668
		Humera Gilani	Comp	TE	8446665513
3	3.Mismatch Day	Humera Gilani	Comp	TE	8446665513
		Sayali Mhatre	Comp	TY	9503506481
		Vishal Thakur	Comp	TY	7507058561
4	4.Saree/Formal day	Duhita Raut	Comp	SE	8605564295
		Raj Savita	Civil	SE	7038686373
5	Mehndi (competition)	Humera Gilani	Comp	TE	8446665513
		Shaikh Jannat	Comp	SY	7378626827
		Manasi Gharat	Comp	SY	7397903247
6	Best out of Waste	Huzefa Baig	IT	TE	8097319851
		Sagar Yadav	Mech	TE	8268667849
		Shweta Patil	IT	TE	9137659452
7	Poster Painting	Rushikesh Shinde	Auto	FE	9527520002
		Mohammad Umar	Civil	TY	9975612359
		Rajan Vishwakarma	Civil	TY	8698401322
		Mansi Gharat	Comp	SY	7397903247
		Shaikh Jannat	Comp	SY	7378626827
8	Rangoli	Simran Patil	IT	SE	8552065374
		Archana Patil	IT	SE	965713359
		Anchal Tiwari	IT	SE	9923314252
9	Floral Decoration	Shaikh Arsalan	Mech	SE	7972240210
		Barish Dindayal	Mech	SE	7040090760
10	Singing	Jaydeep Shiyara	EXTC	BE	7798296623
		Raj Savita	Civil	SE	8208217957
		Pal Sachin	Mech	TY	8600055461
11	Drama	Umar Khan	Civil	TY	9975612359
		Saurabh Gharat	Civil	TY	9823370854
		Santosh S. pandey	Auto	TE	7977286873
		Akash Jadhav	Auto	SE	9370162488



*(Signature)*

		Kaivalya Sawant	Auto	SE	8779665745
		Shweta Pawar	Electrical	SE	9673373718
12	Dance	Kapil J. Rathod	Civil	SE	7021226525
		Sachin Singh	Comp	SE	7387444773
		Sunny Gupta	Comp	SE	7276066761
		Mohit Pandey	Comp	TY	8850464760
		Krishna Bari	Comp	TY	9112102163

 Cultural Coordinator 17/11/19		Principal
Ansar Ahemad Shaikh		Dr. Aqueel Shah



PRINCIPAL  
 THEEM COLLEGE OF ENGINEERING  
 At Village Behgaon, Boisar Chitambar  
 Tal. (East) Tal. & Dist. Patkote - 40





H. J. Thim Trust's  
**Theem College of Engineering, Boisar**  
 Approved by AICTE (New Delhi), Government of Maharashtra and DTE  
 Affiliated to University of Mumbai

**Jashn-E-Theem 2K19**

Sr. No	Events Name	Prizes	Name of Students	Year	Branch	Degree/Diploma
1	1.Traditional + Rose day	2st Runner Up	Alisha Shaikh	TY	Computer	Diploma
			Raj Rajeshwar	SE	ELECTRICAL	Degree
		1st Runner Up	Aditi Tamore	TE	ETRX	Degree
			Kaivalya Kawli	TY	Mechanical	Diploma
		Winner Up	Anjali Purohit	TY	Computer	Diploma
Aditya Hinukale	SE	Automobile	Degree			
2	2. Retro+Chocolate day	2st Runner Up	Sona Yadav	TE	IT	Degree
			Romil Arora	FE	FE	Degree
		1st Runner Up	Nikat Khan	TE	Computer	Degree
			Kaivalya Kawli	TY	Mechanical	Diploma
		Winner Up	Unnati Patil	TE	Computer	Degree
Naveen Garge	TY	Computer	Diploma			
3	3.Mismatch Day	2st Runner Up	Aditi Tamore	TE	ETRX	Degree
			Sunny Arora	BE	Mechanical	Degree
		1st Runner Up	Anjali Purohit	TY	Computer	Diploma
			Rizwan Khan	BE	Mechanical	Degree
		Winner Up	Prerana Sarode	TE	Computer	Degree
Romil Arora	FE	FE	Degree			
4	4. Saree/Formal day	2st Runner Up	Sweta Pawar	SE	ELECTRICAL	Degree
			Vijo Joy	SE	ELECTRICAL	Degree
		1st Runner Up	Shruti Lade	TY	Computer	Diploma
			Atik Khan	TE	Computer	Degree
		Winner Up	Nikat Khan	TE	Computer	Degree
Mohit Pandey	TY	Computer	Diploma			
5	Mehndi	2st Runner Up	Jannat Shaikh	SY	Computer	Diploma
		1st Runner Up	Ayasha Khan	FY	Computer	Diploma
		Winner Up	Masuma Shaikh	BE	EXTC	Degree
6	Best out of Waste	2st Runner Up	Aditi Bhoir	TE	IT	Degree
		1st Runner Up	Yogesh Samsher	TE	mechanical	Degree
			Vivek Singh			
			Aquib Shaikh			
		Winner Up	Anasari Shabazz	BE	Civil	Degree
Mo. Zulfakas Ali						
Hamia Khan						
7	Poster Painting	2st Runner Up	Mansi Kiran Gharat	SY	computer	Diploma
		1st Runner Up	Bhavika Gode	SE	IT	Degree



*[Signature]*

**PRINCIPAL**  
 THEEM COLLEGE OF ENGINEERING  
 At, Village: Belegaon, Boisar Taluka: Palghar  
 Dist: (East) Tal. & Dist. Palghar - 401301

8	Rangoli	Winner Up	Shah Mohd Sameer	BE	Mechanical	Degree
		2st Runner Up	Manasi Gharat	SY	computer	Diploma
		1st Runner Up	Bhavika Gode	SE	IT	Degree
		Winner Up	Archana Patil	SE	IT	Degree
9	Floral Decoration	2st Runner Up	Preell Verma Jagruti Patil	SY	Computer	Diploma
		1st Runner Up	Prerana Sarode	TE	Computer	Degree
		Winner Up	Shruti Lade	TY	Computer	Diploma
10	Singing (compitation)	2st Runner Up	Vinit Pujare	SE	Mechanical	Degree
		1st Runner Up	Wasim Shah	SE	Auto	Degree
		Winner Up	Ajay Shirke	TE	Computer	Degree
11	Dance (Group)	2st Runner Up	Kapil & Group	SE	Civil/Comp/IT	Degree
		1st Runner Up	Aniket & Bhavesh	SY/BE	Mech/Auto	Diploma/Degree
		Winner Up	Aniket & Reena	SY/FY	Mech/Computer	Diploma
12	Dance (Solo)	2st Runner Up	Sakshi Singh	FE	Computer	Degree
		1st Runner Up	Bhavana Singh	TY	Civil	Diploma
		Winner Up	Sona Yadav	TE	IT	Degree

Cultural Coordinator

Ansar Ahmad Shaikh

Principal

Dr. Aqueel Shah



*(Signature)*

PRINCIPAL

THEEM COLLEGE OF ENGINEERING  
At Village Botecon, Boisar Taluka Boisar  
Dist. Palanpur - 382 001

H. J. Thim Trust's  
**Theem College of Engineering, Boisar**  
 Approved by AICTE (New Delhi), Government of Maharashtra and DTE  
 Affiliated to University of Mumbai

**Jashn-E-Theem 2K19**

Sr.	EVENTS	CERTIFICATES			TROPHY	INDIVIDUAL/ GROUP MEMBERS
		Winner Cert.	Part. Cert.	Medals G+S+BR		
1	Traditional + Rose day	2+2+2	-----	2+2+2	-----	1 + 1
2	Retro+Chocolate day	2+2+2	-----	2+2+2	-----	1 + 1
3	Mismatch Day	2+2+2	-----	2+2+2	-----	1 + 1
4	Saree/Formal day	2+2+2	-----	2+2+2	-----	1 + 1
5	Dance Group	7+7+7	10	7+7+7	3(W+R1+R2)	7
6	Dance Solo	1+1+1	5	-----	3(W+R1+R2)	1
7	Mimicry	1+1+1	-----	-----	3(W+R1+R2)	1
8	Mehndi	1+1+1	-----	-----	3(W+R1+R2)	1
9	Rangoli	1+1+1	-----	-----	3(W+R1+R2)	1
10	Floral Decoration	1+1+1	-----	-----	3(W+R1+R2)	1
11	Best out of Waste	3+3+3	-----	3+3+3	3(W+R1+R2)	3
13	Singing Solo	1+1+1	7	-----	3(W+R1+R2)	1
14	Poster Painting	1+1+1	-----	-----	3(W+R1+R2)	1
<b>Total</b>		<b>69</b>	<b>22</b>	<b>45</b>	<b>(9W+9R1+9R2)</b>	
		<b>91</b>				

Note: It is probable list may change based on the number of entries in the event.

Cultural Coordinator

Ansar Ahmed Shaikh

Principal

Dr. Aqueel Shah



*(Signature)*

PRINCIPAL

THEEM COLLEGE OF ENGINEERING  
 M. Village Boregaon, Boisar Chikar Road  
 Boisar (East Tal. & Dist. Palghar)



H. J. Thim Trust's  
**Theem College of Engineering, Boisar**  
Approved by AICTE (New Delhi), Government of Maharashtra and DTE  
Affiliated to University of Mumbai

**Jashn-e-Theem 2K19**

**Circular**

All the [Staff/Student] coordinators are requested to attend the meeting on Cultural Event. The detail of the meeting is given below.  
It is mandatory.

Name of the Event: Cultural coordinator and staff meeting  
Date: 27/02/18  
Time: 01-01 PM  
Venue: IT center.

With Regards,



PRINCIPAL  
THEEM COLLEGE OF ENGINEERING  
At Village Betegao, Boisar Chikar Road  
Boisar (East) Tal. & Dist. Palghar - 401 201



Prof. Ansar Ahemad S.  
Coordinator of the Event  
Cultural

Cultural Coordinator  
Ansar Ahemad Shaikh  
Jashn-e-Theem - 2K19

Event Coordinator  
Cultural Event



H. J. Thim Trust's  
**Theem College of Engineering, Boisar**  
 [Name of the Department]

**Minutes of Meeting — (01)**

Date: 27/10/2018	Location: IT Center
Time: 4 AM/PM	
Called By: Prof. Ansar Ahmed Shaikh	
Timekeeper: — Hrs	Note Taker: Abu-saeed (Assistant)

**Attendees:**

Sr. No	Name of Faculty/ Non-Teaching Faculties	Sign
1	Ruchi Rathi	[Signature]
2	Jyeshree Sati	[Signature]
3	Rishi Bhai	[Signature]
4	Tejas Thakur	[Signature]
5	Vihang Sahu	[Signature]
6	Ashwini Nani	[Signature]
7	Nitin Sall (Auto)	[Signature]
8	Mohd. Mustaque (Auto)	[Signature]
9	Sanket Rout	[Signature]
10	Annam Sankha (Comp)	[Signature]
11	Tejal D. Kumbhar (Comp)	[Signature]
12	Srinivas Patil (App. min)	[Signature]
13	Sayali Mahajan	[Signature]
14	Mohammed Kalamuddin Ansi	[Signature]

**Agenda of Meeting:**

1. Discussion regarding work.
2. Distr. of files.
3. Discussion on schedule of events.
4. Workflow.

**Presenter**

Ansar Ahmed S.  
(Assist. prof.)

Prof. Ansar Ahmed Shaikh  
 Cultural Program Coordinator



[Signature]

**PRINCIPAL**  
 THEEM COLLEGE OF ENGINEERING  
 12, Village Beteagan, Boisar-Chitra Road  
 Boisar (East) Tal. & Dist. Palghar - 407 501

H. J. Theem Trust's  
**Theem College of Engineering, Boisar**  
 Approved by AICTE (New Delhi), Government of Maharashtra and DTE  
 Affiliated to University of Mumbai

**Jashn-E-Theem 2K19**

Sr No	Events Name	Staff Coordinator	Staff Coordinator Mobile Number	Audition 1	Audition 2	Final Event Schedule		
						Date	Time	Venue
1	1 Traditional + Rose Day	Prof. Awan Sanjha (Coordinator) Prof. Sanjha Raut (Co-coordinator) Tejas Thakur (Co-coordinator) (Judges are needed in these events - Internal Judges)	7710023368 7756032817	Not Required		08/01/2019	2:30 PM	Main Entrance Gate - Main Stage
	09/01/2019					2:30 PM		
	10/01/2019					2:30 PM		
	11/01/2019					2:30 PM		
	14/01/2019					11:00 AM		
2	Mehndi (competition)	Prof. Tasneem Azam (Coordinator)	8007273375	Not Required		15/01/2019	3:00 PM	ETRX Class Room Second Floor Old Building
		Sayali Mahajan (Co-Coordinator)	7385097722					
		Prof. Ruchi Rahi (Co-coordinator)	7983904370					
3	Best out of Waste	Prof. Azhar Nabi (Coordinator)	826850316	Not Required		14/01/2019	11:00 AM	
		Prof. Kalamuddin Ansum (Co-coordinator)	8789267489					
		Prof. Vinay Sahu (Co-coordinator)	9665848549					
4	Poster Painting	Prof. Kazi Azmuddin (Coordinator)	9579850730	Not Required		15/01/2019	11:00 AM	
		Prof. S. Reddy (Co-coordinator)	7888434955					
5	Singing (competition)	Prof. Tufiqar (Coordinator)	9923510075	10/01/2019		17 & 18/01/2019	Evening	Main Stage
		Prof. Shob Khan (Co-coordinator)	9768219633					
		Prof. Jayshree Sali (Co-coordinator)	8284996588					
6	Memory (competition)	Prof. Nishu Sali (Coordinator)	8303083306	11/02/2019		17 & 18/01/2019	Evening	Main Stage
		Prof. Mushtaque (Co-coordinator)	8369899148					
7	Dance (competition)	Prof. Faiz Khan (Coordinator)	9175306697	10/01/2019		17 & 18/01/2019	Evening	Main Stage
		Prof. Snehal Pawde (Co-coordinator)	8145662212					
		Prof. Priyanka Dhande (Co-coordinator)	9156867201					
8	Rangoli (competition)	Prof. Rishi Bhai (Coordinator)	9766150629	Not Required		19/01/2019	10:30 AM	Main Passage
		Prof. Ruchi Rahi (Co-coordinator)	7983904370					
		Mrunali Kokate (Co-coordinator)	7709141560					
9	Floral Decoration (competition)	Prof. Tejal Raut (Coordinator)	9950413634	Not Required		19/01/2019	10:30 AM	Main Passage
		Tanya Raut (Co-Coordinator)	9029840796					
10	Drama (performance)	Prof. Abhishek Shakh (Coordinator)	7020203025	11/02/2019		18/01/2018	Evening	Main Stage
		Prof. Geetha Yadav (Co-coordinator)	7038825862					
		Prof. Shauk Hussain (Co-coordinator)	9675105038					

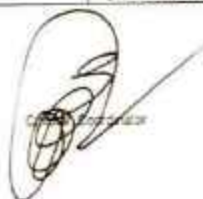

Principal



**PRINCIPAL**  
 THEEM COLLEGE OF ENGINEERING  
 12, Village Borogao, Boisar Office B-  
 Boisar (East) Tal. & Dist. Palghar - 401 301



H.J. THIM TRUST'S  
**Theem College of Engineering**  
**JASHN -E- THEEM 2019**  
**Cultural-2019**

Event Name:- Drama Performance

Entry Form For Participation

Crisis Education  
 Effects of Social media on Students

Sr.No.	Name of Participant	Branch & Year	Contact No.	Entry Fees
1)	Shweta Pawar	S.E. Electrical	8329486817	-
2)	Vividh Tare	B.E. I.T.	9209223512	-
3)	Santosh Pandey	T.E. Auto	7977286873	-
4)	Shashi Kanojiya	S.E. Civil	9823765755	-
5)	Prajakta Koli	S.E. EXTC	8356804047	-
6)	Julee Mallah	S.E. EXTC	7709200191	-
7)	Prerna Sarode	T.E. Comp.	8007093081	-
8)	Unnati Patil	T.E. Comp.	7559419209	-
9)	Akash Jadhav	S.E. Auto	9370162488	-
10)	Kaivalya Sawant	S.E. Auto	8779665745	-
11)	Pratik Bhagat	T.E. Mech	9011355313	-
<p><del>We need participation certificates to distribute to participants of Drama.</del></p> <p><del>total = 11</del></p> <p><del>Eleven</del></p> <p><del>Co-Ordinator</del></p> <p><del>Cultural</del></p> <p><del>20/11/19</del></p>				

Staff Co-ordinator (Name Sign.)

Arbiya Shaikh  



Student Co-ordinator (Name Sign.)

PRINCIPAL  
 THEEM COLLEGE OF ENGINEERING  
 M. Village Betegaon, Boisar Taluka Palghar Dist. Palghar (East) Tal. & Dist. Palghar.

H. J. Thim Trust's

## Theem College of Engineering, Boisar

Approved by AICTE (New Delhi), Government of Maharashtra and DTE

Affiliated to University of Mumbai

### Jashn-E-Theem 2K19

#### Student Coordinator (Event Coordinator)

Name of Event Coordinator:	1. Arbiya Shaikh 2. Shakir Hussain 3. 4. Greetha Tadur
Name of Event:	Drama
Date:	17/10/2019
Time:	4.00 PM
Venue:	Main Stage

Following is the List of Coordinators for the Event:

Sr. No	Name As required on certificate	Degree/Diploma	Branch & Class	Mobile No	Sign
01)	Umar Khan	Diploma	TY-Civil	9975612359	
02)	Saurabh Gharat	Diploma	TY-Civil	9823370859	
03)	Samtosh S. Pardey	Degree	TE-Auto	7977285870	
04)	Akash Jadhav	Degree	SE-Auto	9370162488	
05)	Shweta Pawar	Degree	SE-ELECT	9693373718	
06)	Kaivalya Sawant	Degree	S.E. Auto	8779665745	

Cultural Coordinator  
Ansar Ahmed Shaikh  
Jashn-e-Theem - 2K19







Event Coordinator  
Arbiya Shaikh  
Cultural Event

PRINCIPAL  
THEEM COLLEGE OF ENGINEERING  
Village Beteagan, Boisar, Tal. Palghar, Dist. Palghar

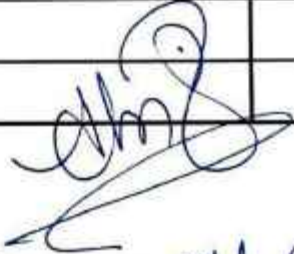

## Athlon 2019 List of the Student Coordinator

Athlon 2019 List of the Student Coordinator			
Event Name :	Cricket ( <del>Box</del> )		
Sr.no	Full Name(Should be in Capital letter)	Branch	Year
1	SHUBHAM BHANDARI	CIVIL	BE
2	SHAIKH EBAD		T.E
3	HITESH JAIN		T.E
4	AKSHAY SAWAL	ELEC.	S.E
5	AHMAD HAMID	& CIVIL	B.E
6	AMARDEEP SINGH	ELEC.	S.E
7	VIRAJ RAUT		S.E
8	KRUPESH SHINDE	<del>MECH.</del> AUTO	T.E
9	MANZIYAR SHAMIM	MECH.	F.E (A)
10	NACHAN ZAINUL		F.Y
11	JOSHIL BARI.		F.Y
12	DURGESH RAUT.	ELEC.	S.E
13			
14			
15			
Fees Collection	Number of Teams: 21		
	Fees/Team 150		
	Total Amount: 3150		
	$3150 - 435 = 2715/-$		
		 Bagwan Md. Ayaz. Sign and Name of Event Coordinator	





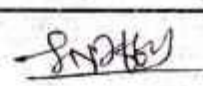

## Athlon 2019 List of the Student Coordinator

Event Name :	KHO - KHO (Girls)		
Sr.no	Full Name(Should be in Capital letter)	Branch	Year
1	APEKSHA NALWADE	Comp	TE
2	FURKAN SHAIKH	I.T	TE
3	SHUBHAM MISHRA	I.T	TE
4	NIMESH MORE	I.T	SE
5	KOHNIT SAINT	Mech	SE
6			
7			
8			
9			
10			
11			
12			
13			
14			
15			
Fees Collection	Number of Teams:	No ENTRY Fee	—
	Fees/Team	—	—
	Total Amount:	—	—
			 Surekha Attarde
			Sign and Name of Event Coordinator





**PRINCIPAL**  
 THEEM COLLEGE OF ENGINEERING  
 1st Village Boregaon, Borsar Chittr P.  
 Borsar (East) Tal & Dist. Palghar - 40

## Athlon 2019 List of the Student Coordinator

Event Name :	Box Cricket		
Sr.no	Full Name(Should be in Capital letter)	Branch	Year
✓ 1	Hardik Raut	Electrical	BE
2	Rajiv Nair		BE
3	Saayabh Tandel		BE
4	Meetkumar Patel		BE
5	Amey More		BE
✓ 6	Mayur Gujar		TE
7	Siddhesh pangrekar		BE
8	Nikhil Keni		TE
9	Gauresh Kumbhar		TE
10	Piyush Patil		BE
11	Siddhant Mahindrakar		BE
12	Shubham Mahajan		BE
13	Harsh Darji		BE
14	Akash Bharti		BE
15	Mandar Patil		BE
Fees Collection	Number of Teams:	23	
	Fees/Team	100 Pes team	
	Total Amount:	2300	
		 PRINCIPAL THEJEN COLLEGE OF ENGINEERING St. Village Boregaon, Bhusar Chikhar Jalgaon (East) Tal. & Dist. Palghar	Rakesh S. Kushwah
			Sign and Name of Event Coordinator

✓ 16)	Tanmay Santhale	Electrical	BE
✓ 17)	Hardik Raut	Civil	TE
✓ 18)	Prashant Korda	Mechanical	BE
✓ 19)	Kartik Kanojia	ExtC	BE
✓ 20)	Ankitkumar Singh	Electrical	BE

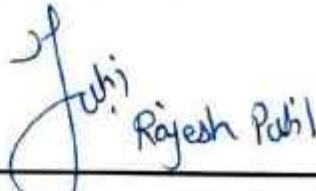
## Athlon 2019 List of the Student Coordinator

Event Name :	VOLLEYBALL		
Sr.no	Full Name(Should be in Capital letter)	Branch	Year
1	CHINMAY R. PIMPLE	CIVIL	TE
2	MANAS H. PIMPLE	MECH	TY
3	SOHIL BARI	MECH	TY
4	DHARAM GHARAJ	MECH	TY
5	SURAJ YADAV	CIVIL	TE
6	PIYUSH P. PATIL	ELEC.	BE
7	/		
8			
9			
10			
11			
12			
13			
14			
15			
Fees Collection	Number of Teams: 16		
	Fees/Team 50/-		
	Total Amount: 800/-		
	 Sign and Name of Event Coordinator		



  
**PRINCIPAL**  
 THEEM COLLEGE OF ENGINEERING,  
 At. Village Betegaon, Borsar Chikher  
 Borsar (East) Tal. & Dist. Patkhar.



Tejal Raut

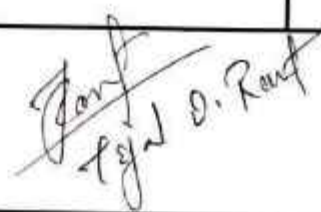

### Athlon 2019 List of the Student Coordinator

Event Name :	kcho kcho Cioo-		
Sr.no	Full Name(Should be in Capital letter)	Branch	Year
1	Kohini M. Jaini	Meehameical Enng	S-E.(1A)
2	Apeksh Nalawadekar.	Computer Enngg.	T.E.
3			
4			
5			
6			
7			
8			
9			
10			
11			
12			
13			
14			
15			
Fees Collection	Number of Teams:		
	Fees/Team		
	Total Amount:		
			 Tejal D. Raut
		Sign and Name of Event Coordinator	

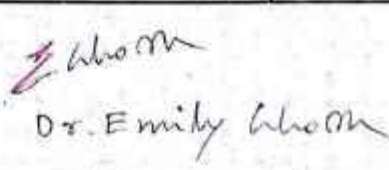

**PRINCIPAL**  
 THEEM COLLEGE OF ENGINEERING  
 At Village Botegaon, Borsar Chittr R...  
 Borsar (East) Tal. & Dist. Palahar - 41

## Athlon 2019 List of the Student Coordinator

Event Name :	CHESS		
Sr.no	Full Name(Should be in Capital letter)	Branch	Year
1	Krushita M. AMBIRE	Electrical	S.E
2	JAIFE K. PATIL	"	S.E
3	ABDULLA ISBAL MEMON	"	S.E
4	ABHINAV DINESH HUSHEA	Computer	S.E
5			
6			
7			
8			
9			
10			
11			
12			
13			
14			
15			
Fees Collection	Number of Teams:		
	Fees/Team		
	Total Amount:		
		 Dr. Emily Whom	
			

Sign and Name of Event Coordinator

  
**PRINCIPAL**  
**THEEM COLLEGE OF ENGINEERING**  
 At Village Betsgaon, Boisar, Tal. Boisar, Dist. Palghar - 407 504.

## Athlon 2019 List of the Student Coordinator

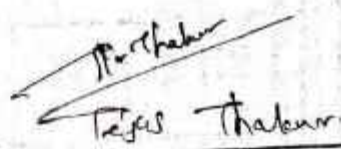
Event Name :	Tug of War		
Sr.no	Full Name(Should be in Capital letter)	Branch	Year
1	ANSARI MOHD. TALIB	Computer	S.E
2	ADITYA HINUKALE	Automobile.	S.E.
3	DURGA BHOJ	Civil	T.E.
4	IRAM GAWANDI	Civil	B.F.
5	VIVEK GUPTA	Computer	S.E
6	<del>Akash Singh</del>	<del>Automobile</del>	<del>S.E</del>
7	Ashish Singh		
8			
9			
10			
11			
12			
13			
14			
15			
Fees Collection	Number of Teams:	16 Boys team 8 girls team	
	Fees/Team	50/- Rs. for Boys only per team.	
	Total Amount:	800/- Rs	
		 Tejesh Thakur	
		Sign and Name of Event Coordinator	



**PRINCIPAL**  
 THEEM COLLEGE OF ENGINEERING  
 41, Village Bongaon, Bolar, Chitragarh  
 District (East) Tal. & Dist. Palasbari - 74



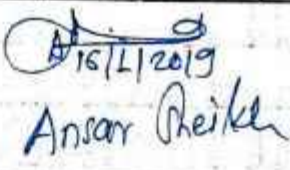

## Athlon 2019 List of the Student Coordinator

Event Name :	Athletics (Boys) [shot put, Discuss, Javelin, Running]		
Sr.no	Full Name(Should be in Capital letter)	Branch	Year
1	SHUBHAM BHANDARI	B: Civil	B.E
2	FURKAN SHAIKH	I: Computer	T.E
3			
4			
5			
6			
7			
8			
9			
10			
11			
12			
13			
14			
15			
<b>Fees Collection</b>	Number of Teams:		
	Fees/Team		
	Total Amount: <span style="font-size: 1.2em; margin-left: 100px;">910</span>		
		 16/11/2019 Ansari Sheikh	
		Sign and Name of Event Coordinator	



**PRINCIPAL**  
 THE COLLEGE OF ENGINEERING  
 No. Village Betegaon, Bolar Chikher P.  
 Bolar (East) Tal. & Dist. Palanpur

H. J. Thim Trust's  
**Theem College of Engineering, Boisar**  
 Approved by AICTE (New Delhi), Government of Maharashtra and DTE  
 Affiliated to University of Mumbai

**Jashn-E-Theem 2K19**

Sr. No	Events Name	Sr. No	Students Coordinator	Branch	Year	Students Coordinator Mobile Number	Staff Co-ordinator Sigh.
1	1. Traditional + Rose day	1	Shruti Lade	Comp	TY	9503506481	
		2	Vishal Thakur	Comp	TY	7507058561	
		3	Pradnya Patil	Comp	TY	9763600668	
2	2. Retro+Chocolat e day	4	Shruti Lade	Comp	TY	9503506481	
		5	Pradnya Patil	Comp	TY	9763600668	
		6	Humera Gilani	Comp	TE	8446665513	
3	3. Mismatch Day	7	Humera Gilani	Comp	TE	8446665513	
		8	Sayali Mhatre	Comp	TY	9503506481	
		9	Vishal Thakur	Comp	TY	7507058561	
4	4. Saree/Formal day	10	Duhita Raut	Comp	SE	8605564295	
		11	Raj Savita	Civil	SE	703866373	
5	Mehndi (competition)	12	Humera Gilani	Comp	TE	8446665513	
		13	Shaikh Jannat	Comp	SY	7378626827	
		14	Manasi Gharat	Comp	SY	7397903247	
6	Best out of Waste	15	Huzefa Bag	IT	TE	8097319851	
		16	Sagar Yadav	Mech	TE	8268667849	
		17	Shweta Patil	IT	TE	9137659452	
7	Poster Painting	18	Rushikesh Shinde	Auto	FE	9527520002	
		19	Mohammad Umar	Civil	TY	9975612359	
		20	Rajan Vishwakarma	Civil	TY	8698401322	
		21	Manasi Gharat -	Comp	SY	7397903247	
		22	Shaikh Jannat	Comp	SY	7378626827	
8	Rangoli	23	Simran Patil	IT	SE	8552065374	
		24	Archana Patil	IT	SE	965713359	
		25	Anchal Tiwari	IT	SE	8923314252	
9	Floral Decoration	26	Shaikh Arsalan	Mech	SE	7972240210	
		27	Barish Dindayal	Mech	SE	7040090760	
10	Singing	28	Jaydeep Shiyara	EXTC	BE	7798296623	
		29	Raj Savita	Civil	SE	8208217957	
		30	Pal Sachin	Mech	TY	8600655461	
11	Drama	31	Umar Khan	Civil	TY	9975612359	
		32	Saurabh Gharat	Civil	TY	9823370854	
		33	Santosh S. pandey	Auto	TE	7977286873	
		34	Akash Jadhav	Auto	SE	9370162488	
		35	Kaivalya Sawant	Auto	SE	8779865745	
		36	Shweta Pawar	Electrical	SE	9673373718	
12	Dance	37	Kapil J. Rathod	Civil	SE	7021228525	
		38	Sachin Singh	Comp	SE	7387444773	
		39	Sunny Gupta	Comp	SE	7276666761	
		40	Mohit Pandey	Comp	TY	8850464760	
		41	Krishna Bari	Comp	TY	9112102163	

Cultural Coordinator  
 Anwar Ahmad Shaikh



PRINCIPAL  
 THEEM COLLEGE OF ENGINEERING  
 At. Village Belegaon, Boisar Chikher Road,  
 Boisar (East) Tal. & Dist. Palghar - 401 301



H. J. Thim Trust's  
**Theem College of Engineering, Boisar**  
 Approved by AICTE (New Delhi), Government of Maharashtra and DTE  
 Affiliated to University of Mumbai

**Jashn-E-Theem 2K19**

Sr. No	Events Name	Sr. No	Students Coordinator	Branch	Year	Students Coordinator Mobile Number	Staff Co-ordinator Sigh.
1	1. Traditional + Rose day	1	Shruti Lade ✓	Comp	TY	9503506481	
		2	Vishal Thakur ✓	Comp	TY	7507058561	
		3	Pradnya Patil ✓	Comp	TY	9763600668	
2	2. Retro+Chocolate day	4	Shruti Lade ✓	Comp	TY	9503506481	
		5	Pradnya Patil ✓	Comp	TY	9763600668	
		6	Humera Gilani ✓	Comp	TE	8446665513	
3	3. Mismatch Day	7	Humera Gilani ✓	Comp	TE	8446665513	
		8	Sayali Mhatre ✓	Comp	TY	9503506481	
		9	Vishal Thakur ✓	Comp	TY	7507058561	
4	4. Saree/Formal day	10	Duhita Raut ✓	Comp	SE	8605564295	
		11	Raj Savita ✓	Civil	SE	7036686373	
5	Mehndi (competition)	12	Humera Gilani ✓	Comp	TE	8446665513	
		13	Shaikh Jannat ✓	Comp	SY	7378626827	
		14	Manasi Gharat ✓	Comp	SY	7397903247	
6	Best out of Waste	15	Huzefa Baig ✓	IT	TE	8097319851	
		16	Sagar Yadav ✓	Mech	TE	8268667849	
		17	Shweta Patil ✓	IT	TE	9137659452	
7	Poster Painting	18	Rushikesh Shinde ✓	Auto	FE	9527520002	
		19	Mohammad Umar ✓	Civil	TY	9975612359	
		20	Rajan Vishwakarma ✓	Civil	TY	8698401322	
		21	Mansi Gharat ✓	Comp	SY	7397903247	
		22	Shaikh Jannat ✓	Comp	SY	7378626827	
8	Rangoli	23	Simran Patil ✓	IT	SE	8552055374	
		24	Archana Patil ✓	IT	SE	965713359	
		25	Anchal Tiwan ✓	IT	SE	9923314252	
9	Floral Decoration	26	Shaikh Arsalan ✓	Mech	SE	7972240210	
		27	Barishi Dindayal ✓	Mech	SE	7040090760	
10	Singing	28	Jaydeep Shiyara ✓	EXTC	BE	7798296823	
		29	Raj Savita ✓	Civil	SE	8208217957	
		30	Pal Sechin ✓	Mech	TY	8600055461	
11	Drama	31	Umar Khan ✓	Civil	TY	9975612359	
		32	Saurabh Gharat ✓	Civil	TY	9823370854	
		33	Santosh S. pandey ✓	Auto	TE	7977286873	
		34	Akash Jadhav ✓	Auto	SE	9370162486	
		35	Kaivalya Sawant ✓	Auto	SE	8779665745	
		36	Shweta Pawar ✓	Electrical	SE	9673373718	
12	Dance	37	Kapil J. Rathod ✓	Civil	SE	7021226525	
		38	Sechin Singh ✓	Comp	SE	7387444773	
		39	Sunny Gupta ✓	Comp	SE	7276066761	
		40	Mohit Pandey ✓	Comp	TY	8850464760	
		41	Krishna Bari ✓	Comp	TY	9112102163	

Krishma Bari

Cultural Coordinator  
 Ansar Ahmad Shaikh



*(Signature)*

**PRINCIPAL**  
 THEEM COLLEGE OF ENGINEERING  
 At Village Betegaon, Boisar-Chillar Road  
 Boisar (East) Tal. & Dist. Palghar - 401 301

File Doc. Seq. No	Event/Document	1 Dance			
		Schedule Date	Submitted Date	Remark	Cultural Coord. Sign
1	Faculty Coord.	26/12/2018			
2	Student Coord	29/12/2018			
3	Meeting 0 agenda + Meeting Circular	29/12/2018			
4	Work Distribution	29/12/2018			
5	Requirment	29/12/2018			
6	Judges Requirement	29/12/2018			
7	Evaluation Sheet	10/01/2019			
8	Evaluation Parameter	10/01/2019			
9	Poster & Phamplet	10/01/2019			
10	Participant List	11/01/2019			
11	Judges Invitation	14/01/2019			
12	Execution Seq.	14/01/2019			
13	Final Winner List	18/01/2019			
14	Closure Report [1]	21/01/19			
15	Expenditure Bills	21/01/2019			
16	Observation & Remedy	21/01/2019			
17	Photo of the Event	21/01/2019			

  
 18/01/19



  
**PRINCIPAL**  
 THEEM COLLEGE OF ENGINEERING  
 At Village Betegaon, Boisar Chikhar Road  
 Boisar (East) Tal. & Dist. Palahar, M.P.

H. J. Thim Trust's  
**Theem College of Engineering, Boisar**  
 Approved by AICTE (New Delhi), Government of Maharashtra and DTE  
 Affiliated to University of Mumbai

**Jashn-E-Theem 2K19**

Sr. No	Events Name	Staff Coordinator	Staff Coordinator Mobile Number	Total Expense	Entry Fees	No. of Participants	Amount
1	1.Traditional + Rose day	Prof. Awani Sankhe	7710023368	None	0	-	0
	2.Retro+Chocolate day						
	3.Mismatch Day	Prof. Sanketi Raut	7756032877				
	4.Saree/Formal day	Prof. Tejas Thakur					
2	Mehndi	Prof. Tasneem Azam	8007273375	None	0	-	0
		Sayali Mahajan	7385097722				
		Prof. Ruchi Rahi	7983904370				
3	Best out of Waste	Prof. Azhar Nabi	826850316	None	20	10	200
		Prof. Kalamuddin Ansari	8789267489				
		Prof. Vinay Sahu	8655848549				
4	Poster Painting	Prof. Kazi Azimuddin	9579850730	None	20	17	340
		Prof. S. Reddy	7588434855				
5	Singing	Prof. Zulfqar	9923510075	None	20	16	320
		Prof. shoib Khan	9768219633				
		Prof. Jayshree Sali	9284996588				
6	Mimicry	Prof. Nitin Sali	9503088306	None	0	-	0
		Prof. Mushtaque	8369899145				
7	Dance	Prof. Faiz Khan	9175306697	None	20	18	360
		Prof. Snehal Pawde	8149585212				
		Prof. Priyanka Dhande	9156867201				
8	Rangoli	Prof. Rosy Bhoi	9766160629	None	0	-	0
		Prof. Ruchi Rahi	7983904370				
		Mrunali Kokate	7709141560				
9	Floral Decoration	Prof. Tejal Raut	9950413634	None	0	-	0
		Tanvi Raut	9029840796				
10	Drama	Prof. Arbiya Shaikh	7020203625	400	0	-	0
		Prof. Geetha Yadur	7038825862				
		Prof. Shakir Hussain	9579105036				
<b>Total</b>				<b>400</b>	<b>-</b>	<b>61</b>	<b>1220</b>

Cultural Coordinator

Ansar Ahmad Shaikh

Account Officer

Mohd. Jafrulla Khan Kayani

PRINCIPAL

THEEM COLLEGE OF ENGINEERING,  
 Village Bategaon, Boisar, Tal. Chiplun, Dist. Palghar



H. J. Thim Trust's  
**Theem College of Engineering, Boisar**  
 Approved by AICTE (New Delhi), Government of Maharashtra and DTE  
 Affiliated to University of Mumbai

**Jashn-E-Theem 2K19**

Sr. No	Participant/Rep. Name	Contact No.	Song/Theme	Time
<b>SINGING</b>				
1	Saurabh Gharat	9823370854	Tere Naam	4:15:00 PM ONWARDS
2	Shubham Patil	7066853982	Jaaye na Jaayena	
3	Ajay Shirke	8169178869	Aayat	
4	Pariksha Pimple	7738354517	Baba	
5	Rakhi Jha	9545750834	moh moh k dhage	
6	Washi Shah	9271447791	Dolna	
7	Vinit Pujari	9823818738	Laa Ishq/Dil diya galla	
8	Jaydeep	7798296623	Chunar	
9	Shahinshah	8624878635	RAP	
<b>SPORTS PRIZE DISTRIBUTION</b>				
10	<b>DRAMA (Effect of Social Media on youth)</b>			
<b>DANCE</b>				
11	Aniket & Bhavesh	9082447082	Koli Song	Group
12	Sona Yadav	7738667217	Diwani Mastani	Solo
13	Sakshi Singh	7507978218	Aafreen	Solo
14	Vividh Tare	9209223512	Simbha	Solo
15	Apeksha Nalwade	8788453566	Tribute to Madhuri	Solo
17	Rajshree Pachpande	7448015503	Sun Sathiya	Solo
18	Aniket & Reena	90822447082	Tujhe Reshmi Kale Baal	Group
19	Kapil Rathod	7021226525	Mix Song	Group
20	Bhavna Singh	8208267765	Tribute to Madhuri	Solo
21	<b>DRAMA (Girls Education)</b>			
<b>SINGING &amp; DANCE PRIZE DISTRIBUTION</b>				
Internal Coordinator <div style="text-align: right;">                       Anzar Akhbar Shaikh                      Assistant Professor - Dept. of IT                 </div>				



**PRINCIPAL**  
 THEEM COLLEGE OF ENGINEERING  
 St. Village Boregon, Boisar Chitkar E-1  
 Boisar (East) Tal. & Dist. Palghar



H. J. Thim Trust's  
**Theem College of Engineering, Boisar**  
 Approved by AICTE (New Delhi), Government of Maharashtra and DTE  
 Affiliated to University of Mumbai

Cultural Night Approx Time

Event	Type	No. of Performances	Approx. Time	Total Time
Singing	Solo	9	6	54
Dance	Solo	6	5	30
	Group	3	7	21
Drama	Group	2	12	24
Total Time				2.15

Cultural Coordinator

Ansar Ahamad Shaikh

Principal

Dr. Aqueel Shah



**PRINCIPAL**  
 THEEM COLLEGE OF ENGINEERING  
 M. Village Belgaon, Boisar Tal. Dist. Palghar

H. J. Thim Trust's  
**Theem College of Engineering, Boisar**  
 Approved by AICTE (New Delhi), Government of Maharashtra and DTE  
 Affiliated to University of Mumbai

**Jashn-E-Theem 2K19**

Sr. No	Events Name	Students Coordinator	Branch	Year	Students Coordinator Mobile Number
1	1.Traditional + Rose day	Shruti Lade	Comp	TY	9503506481
		Vishal Thakur	Comp	TY	7507058561
		Pradnya Patil	Comp	TY	9763600668
2	2. Retro+Chocolate day	Shruti Lade	Comp	TY	9503506481
		Pradnya Patil	Comp	TY	9763600668
		Humera Gilani	Comp	TE	8446665513
3	3.Mismatch Day	Humera Gilani	Comp	TE	8446665513
		Sayali Mhatre	Comp	TY	9503506481
		Vishal Thakur	Comp	TY	7507058561
4	4.Saree/Formal day	Duhita Raut	Comp	SE	8605564295
		Raj Savita	Civil	SE	7038686373
5	Mehndi (competition)	Humera Gilani	Comp	TE	8446665513
		Shaikh Jannat	Comp	SY	7378626827
		Manasi Gharat	Comp	SY	7397903247
6	Best out of Waste	Huzefa Baig	IT	TE	8097319851
		Sagar Yadav	Mech	TE	8268667849
		Shweta Patil	IT	TE	9137659452
7	Poster Painting	Rushikesh Shinde	Auto	FE	9527520002
		Mohammad Umar	Civil	TY	9975612359
		Rajan Vishwakarma	Civil	TY	8698401322
		Mansi Gharat	Comp	SY	7397903247
		Shaikh Jannat	Comp	SY	7378626827
8	Rangoli	Simran Patil	IT	SE	8552065374
		Archana Patil	IT	SE	965713359
		Anchal Tiwari	IT	SE	9923314252
9	Floral Decoration	Shaikh Arsalan	Mech	SE	7972240210
		Barisht Dindayal	Mech	SE	7040090760
10	Singing	Jaydeep Shiyara	EXTC	BE	7798296623
		Raj Savita	Civil	SE	8208217957
		Pal Sachin	Mech	TY	8600055461
11	Drama	Umar Khan	Civil	TY	9975612359
		Saurabh Gharat	Civil	TY	9823370854
		Santosh S. pandey	Auto	TE	7977286873
		Akash Jadhav	Auto	SE	9370162488



*(Signature)*

**PRINCIPAL**  
 THEEM COLLEGE OF ENGINEERING  
 At Village Borsgaon, Boisar Tal. Boisar Dist. Palghar - 401 301



		Kaivalya Sawant	Auto	SE	8779665745
		Shweta Pawar	Electrical	SE	9673373718
12	Dance	Kapil J. Rathod	Civil	SE	7021226525
		Sachin Singh	Comp	SE	7387444773
		Sunny Gupta	Comp	SE	7276066761
		Mohit Pandey	Comp	TY	8850464760
		Krishna Bari	Comp	TY	9112102163

 Cultural Coordinator 17/11/19		Principal
Ansar Ahemad Shaikh		Dr. Aqueel Shah



PRINCIPAL  
 THEEM COLLEGE OF ENGINEERING,  
 St. Village Betogzon, Bohar Chitliya Rd,  
 Coisar (East) Tal. & Dist. Palghar.



H. J. Thim Trust's  
**Theem College of Engineering, Boisar**  
 Approved by AICTE (New Delhi), Government of Maharashtra and DTE  
 Affiliated to University of Mumbai

**Jashn-E-Theem 2K19**

Sr. No	Events Name	Prizes	Name of Students	Year	Branch	Degree/Diploma
1	1.Traditional + Rose day	2st Runner Up	Alisha Shaikh	TY	Computer	Diploma
			Raj Rajeshwar	SE	ELECTRICAL	Degree
		1st Runner Up	Aditi Tamore	TE	ETRX	Degree
			Kaivalya Kawli	TY	Mechanical	Diploma
		Winner Up	Anjali Purohit	TY	Computer	Diploma
Aditya Hinukale	SE		Automobile	Degree		
2	2. Retro+Chocolate day	2st Runner Up	Sona Yadav	TE	IT	Degree
			Romil Arora	FE	FE	Degree
		1st Runner Up	Nikat Khan	TE	Computer	Degree
			Kaivalya Kawli	TY	Mechanical	Diploma
		Winner Up	Unnati Patil	TE	Computer	Degree
Naveen Garge	TY		Computer	Diploma		
3	3.Mismatch Day	2st Runner Up	Aditi Tamore	TE	ETRX	Degree
			Sunny Arora	BE	Mechanical	Degree
		1st Runner Up	Anjali Purohit	TY	Computer	Diploma
			Rizwan Khan	BE	Mechanical	Degree
		Winner Up	Prerana Sarode	TE	Computer	Degree
Romil Arora	FE		FE	Degree		
4	4. Saree/Formal day	2st Runner Up	Sweta Pawar	SE	ELECTRICAL	Degree
			Vijo Joy	SE	ELECTRICAL	Degree
		1st Runner Up	Shruti Lade	TY	Computer	Diploma
			Atik Khan	TE	Computer	Degree
		Winner Up	Nikat Khan	TE	Computer	Degree
Mohit Pandey	TY		Computer	Diploma		
5	Mehndi	2st Runner Up	Jannat Shaikh	SY	Computer	Diploma
		1st Runner Up	Ayesha Khan	FY	Computer	Diploma
		Winner Up	Masuma Shaikh	BE	EXTC	Degree
6	Best out of Waste	2st Runner Up	Aditi Bhoir	TE	IT	Degree
		1st Runner Up	Yogesh Samsher	TE	mechanical	Degree
			Vivek Singh			
			Aquib Shaikh			
		Winner Up	Anasari Shabazz	BE	Civil	Degree
Mo. Zulfakas Ali						
7	Poster Painting	2st Runner Up	Mansi Kiran Gharat	SY	computer	Diploma
		1st Runner Up	Bhavika Gode	SE	IT	Degree



*(Signature)*

**PRINCIPAL**  
 THEEM COLLEGE OF ENGINEERING  
 At Village Betgaon, Boisar District Palghar  
 Near (East) Tal. & Dist. Palghar

8	Rangoli	Winner Up	Shah Mohd Sameer	BE	Mechanical	Degree
		2st Runner Up	Manasi Gharat	SY	computer	Diploma
		1st Runner Up	Bhavika Gode	SE	IT	Degree
		Winner Up	Archana Patil	SE	IT	Degree
9	Floral Decoration	2st Runner Up	Preeti Verma Jagruti Patil	SY	Computer	Diploma
		1st Runner Up	Prerana Sarode	TE	Computer	Degree
		Winner Up	Shruti Lade	TY	Computer	Diploma
10	Singing (compitation)	2st Runner Up	Vinit Pujare	SE	Mechanical	Degree
		1st Runner Up	Wasim Shah	SE	Auto	Degree
		Winner Up	Ajay Shirke	TE	Computer	Degree
11	Dance (Group)	2st Runner Up	Kapil & Group	SE	Civil/Comp/IT	Degree
		1st Runner Up	Aniket & Bhavesh	SY/BE	Mech/Auto	Diploma/Degree
		Winner Up	Aniket & Reena	SY/FY	Mech/Computer	Diploma
12	Dance (Solo)	2st Runner Up	Sakshi Singh	FE	Computer	Degree
		1st Runner Up	Bhavana Singh	TY	Civil	Diploma
		Winner Up	Sona Yadav	TE	IT	Degree

Cultural Coordinator

Ansar Ahmad Shaikh

Principal

Dr. Aqueel Shah



PRINCIPAL  
THEEM COLLEGE OF ENGINEERING  
14, Village Betegao, Boisar Ch/Prar Rd.  
Dist. Palghar



H. J. Thim Trust's  
**Theem College of Engineering, Boisar**  
 Approved by AICTE (New Delhi), Government of Maharashtra and DTE  
 Affiliated to University of Mumbai

**Jashn-E-Theem 2K19**

Sr.	EVENTS	CERTIFICATES			TROPHY	INDIVIDUAL/ GROUP MEMBERS
		Winner Cert.	Part. Cert.	Medals G+S+BR		
1	Traditional + Rose day	2+2+2	-----	2+2+2	-----	1 + 1
2	Retro+Chocolate day	2+2+2	-----	2+2+2	-----	1 + 1
3	Mismatch Day	2+2+2	-----	2+2+2	-----	1 + 1
4	Saree/Formal day	2+2+2	-----	2+2+2	-----	1 + 1
5	Dance Group	7+7+7	10	7+7+7	3(W+R1+R2)	7
6	Dance Solo	1+1+1	5	-----	3(W+R1+R2)	1
7	Mimicry	1+1+1	-----	-----	3(W+R1+R2)	1
8	Mehndi	1+1+1	-----	-----	3(W+R1+R2)	1
9	Rangoli	1+1+1	-----	-----	3(W+R1+R2)	1
10	Floral Decoration	1+1+1	-----	-----	3(W+R1+R2)	1
11	Best out of Waste	3+3+3	-----	3+3+3	3(W+R1+R2)	3
13	Singing Solo	1+1+1	7	-----	3(W+R1+R2)	1
14	Poster Painting	1+1+1	-----	-----	3(W+R1+R2)	1
<b>Total</b>		<b>69</b>	<b>22</b>	<b>45</b>	<b>(9W+9R1+9R2)</b>	
		<b>91</b>				

Note: It is probable list may change based on the number of entries in the event.

Cultural Coordinator

Ansar Khemad Shaikh

Principal

Dr. Aqueel Shah



*(Signature)*

PRINCIPAL

THEEM COLLEGE OF ENGINEERING  
 1st. Village Belegaon, Boisar Taluka Tal. & Dist. Palghar

H. J. Thim Trust's  
**Theem College of Engineering, Boisar**  
Approved by AICTE (New Delhi), Government of Maharashtra and DTE  
Affiliated to University of Mumbai

**Jashn-e-Theem 2K19**

**Circular**

All the [Staff/Student] coordinators are requested to attend the meeting on Cultural Event. The detail of the meeting is given below.  
It is mandatory.

Name of the Event: Cultural coordinator and staff meeting  
Date: 27/02/18  
Time: 01-01 PM  
Venue: IT center.

With Regards,

Prof. Ansar Ahemad S.  
Coordinator of the Event  
Cultural

Cultural Coordinator  
Ansar Ahemad Shaikh  
Jashn-e-Theem - 2K19



  
PRINCIPAL  
THEEM COLLEGE OF ENGINEERING  
At Village Benegaon, Boisar Chitambar Road  
Near East Tal. & Dist. Palghar

Event Coordinator  
Cultural Event



H. J. Thim Trust's  
**Theem College of Engineering, Boisar**  
 [Name of the Department]

**Minutes of Meeting – (01)**

Date: 27/10/2018 Location: IT Center  
 Time: 4 AM/PM  
 Called By: Prof. Ansar Ahmed Shaikh  
 Timekeeper: — Hrs Note Taker: Abu-saeed (Assistant)

**Attendees:**

Sr. No	Name of Faculty/ Non-Teaching Faculties	Sign
1	Ruchi Rathi	
2	Jyeshree Sati	
3	Rajesh Bhoi	
4	Tejas Thakur	
5	Vihang Sahu	
6	Ashwini Nani	
7	Nitin Sall (Auto)	
8	Mohd. Mustaque (Auto)	
9	Sanket Rout	
10	Annam Sankha (Comp)	
11	Tejal D. Kumbhar (Comp)	
12	Srinivas Patil (App. min)	
13	Sayali Mahajan	
14	Mohammed Kalamuddin Ansi	

**Agenda of Meeting:**

1. Discussion regarding work.
2. Distr. of files.
3. Discussion on schedule of events.
4. Workflow.

**Presenter**

Ansar Ahmed S.  
(Assist. prof)

Prof. Ansar Ahmed Shaikh  
 Cultural Program Coordinator



**PRINCIPAL**  
 THEEM COLLEGE OF ENGINEERING  
 St. Village Boregaon, Boisar Chitli Road  
 Boisar (East) Tal. & Dist. Palghar, MH



H. J. Them Trusts

**Theem College of Engineering, Boisar**Approved by AICTE (New Delhi), Government of Maharashtra and DTE  
Affiliated to University of Mumbai**Jashn-E-Theem 2K19**

Sr No	Events Name	Staff Coordinator	Staff Coordinator Mobile Number	Audition 1	Audition 2	Final Event Schedule		
						Date	Time	Venue
1	1 Traditional + Rose Day	Prof. Awan Sanjha (Coordinator) Prof. Sanjha Raut (Co-coordinator) Tejas Thakur (Co-coordinator) (Judges are needed in these events - Internal Judges)	7710023368 7756032817	Not Required		08/01/2019	2:30 PM	Main Entrance Gate - Main Stage
	09/01/2019					2:30 PM		
	10/01/2019					2:30 PM		
	11/01/2019					2:30 PM		
	14/01/2019					11:00 AM		
2	Mehndi (competition)	Prof. Tasneem Azam (Coordinator)	8007273375	Not Required		16/01/2019	3:00 PM	ETRX Class Room Second Floor Old Building
		Sayali Mahajan (Co-Coordinator)	7385097722					
		Prof. Ruchi Rahi (Co-coordinator)	7983904370					
3	Best out of Waste	Prof. Azhar Nabi (Coordinator)	826850316	Not Required		14/01/2019	11:00 AM	
		Prof. Kalamuddin Ansum (Co-coordinator)	8789267489					
		Prof. Vinay Sahu (Co-coordinator)	9665848549					
4	Poster Painting	Prof. Kazi Azmuddin (Coordinator)	9579850730	Not Required		15/01/2019	11:00 AM	
		Prof. S. Reddy (Co-coordinator)	7588434955					
5	Singing (competition)	Prof. Tufiqar (Coordinator)	9923510075	10/01/2019		17 & 18/01/2019	Evening	Main Stage
		Prof. Shoib Khan (Co-coordinator)	9768219633					
		Prof. Jayshree Sali (Co-coordinator)	9284996588					
6	Memory (competition)	Prof. Nishu Sali (Coordinator)	8303083306	11/02/2019		17 & 18/01/2019	Evening	Main Stage
		Prof. Mushtaque (Co-coordinator)	8369899149					
7	Dance (competition)	Prof. Faiz Khan (Coordinator)	9175306697	10/01/2019		17 & 18/01/2019	Evening	Main Stage
		Prof. Snehal Pawde (Co-coordinator)	8145662212					
		Prof. Priyanka Dhande (Co-coordinator)	9156867201					
8	Rangoli (competition)	Prof. Rishi Bhai (Coordinator)	9766106029	Not Required		19/01/2019	10:30 AM	Main Passage
		Prof. Ruchi Rahi (Co-coordinator)	7983904370					
		Mrunali Kokate (Co-coordinator)	7709141560					
9	Floral Decoration (competition)	Prof. Tejal Raut (Coordinator)	9950413634	Not Required		19/01/2019	10:30 AM	Main Passage
		Tanya Raut (Co-Coordinator)	9029840796					
10	Drama (performance)	Prof. Abhishek Shakh (Coordinator)	7020203025	11/02/2019		18/01/2018	Evening	Main Stage
		Prof. Geetha Yadav (Co-coordinator)	7038825862					
		Prof. Shaur Hussain (Co-coordinator)	9675105038					

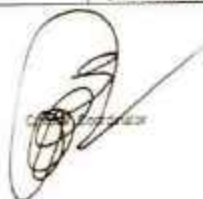

Principal



PRINCIPAL  
THEEM COLLEGE OF ENGINEERING  
11, Village Britegan, Boisar Chitrapur  
Boisar (East) Tal. & Dist. Palghar - 40

H.J. THIM TRUST'S  
**Theem College of Engineering**  
**JASHN -E- THEEM 2019**  
**Cultural-2019**

Event Name:- Drama Performance

Entry Form For Participation

Girls Education  
 Effects of Social media on Students

Sr.No.	Name of Participant	Branch & Year	Contact No.	Entry Fees
1)	Shweta Pawar	S.E. Electrical	8329486817	-
2)	Vividh Tare	B.E. I.T.	9209223512	-
3)	Santosh Pandey	T.E. Auto	7977286873	-
4)	Shashi Kanojiya	S.E. Civil	9823765755	-
5)	Prajakta Koli	S.E. EXTC	8356804047	-
6)	Julee Mallah	S.E. EXTC	7709200191	-
7)	Prerna Sarode	T.E. Comp.	8007093081	-
8)	Unnati Patil	T.E. Comp.	7559419209	-
9)	Akash Jadhav	S.E. Auto	9370162488	-
10)	Kaivalya Sawant	S.E. Auto	8779665745	-
11)	Pratik Bhagat	T.E. Mech	9011355313	-
<p><del>We need participation certificates to distribute it to participants of Drama.</del></p> <p><del>total = 11</del></p> <p><del>Eleven</del></p> <p><del>Cultural</del></p> <p><del>13/01/19</del></p>				

Staff Co-ordinator (Name Sign.)

Arbiya Shaikh  



~~Student Co-ordinator (Name Sign.)~~



PRINCIPAL  
 THEEM COLLEGE OF ENGINEERING  
 At Village Beteagan, Baramulla, Dist. Pulwama

H. J. Thim Trust's

## Theem College of Engineering, Boisar

Approved by AICTE (New Delhi), Government of Maharashtra and DTE

Affiliated to University of Mumbai

### Jashn-E-Theem 2K19

#### Student Coordinator

(Event Coordinator)

Name of Event Coordinator:

1. Arbiya Shaikh
2. Shakir Hussain
3. Greetha Tadur
- 4.

Name of Event:

Drama

Date:

17/01/2019





Time:

4.00 PM

Venue:

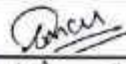
Main Stage

Following is the List of Coordinators for the Event:

Sr. No	Name As required on certificate	Degree/ Diploma	Branch & Class	Mobile No	Sign
01)	Umar Khan	Diploma	TY-Civil	9975612359	
02)	Saurabh Gharat	Diploma	TY-Civil	9823370859	
03)	Samtosh S. Pardey	Degree	TE-Auto	7977285870	
04)	Akash Jadhav	Degree	SE-Auto	9370162488	
05)	Shweta Pawar	Degree	SE-ELECT	9693373718	
06)	Kaivalya Sawant	Degree	S.E. Auto	87799665745	
					
					<b>PRINCIPAL</b> THEEM COLLEGE OF ENGINEERING At Village: Sursagar, Boisar, Taluka: Boisar Dist: Palghar, Maharashtra - 401302

Cultural Coordinator  
Ansar Ahmed Shaikh  
Jashn-e-Theem - 2K19



Event Coordinator  
Arbiya Shaikh  
Cultural Event



H. J. Thim Trust's

## Theem College of Engineering, Boisar

Approved by AICTE (New Delhi), Government of Maharashtra and DTE

Affiliated to University of Mumbai

### Jashn-E-Theem 2K19

#### Circular

All the coordinators are requested to attend the meeting on 07/01/19. The detail of the meeting is given below.

It is mandatory.

Date: 07/01/19

Time: 10:00 a.m.

Name of the Event: Drama Performance.

Venue: MTRX LAB

With Regards,

  
Cultural Coordinator  
Ansar Ahmed Shaikh  
Jashn-e-Theem - 2K19



  
PRINCIPAL  
THEEM COLLEGE OF ENGINEERING  
St. Village Beteagan, Boisar, District Palghar  
Boisar (East Tal. & Dist. Palghar)

  
Event Coordinator  
Arbiya Shaikh  
Cultural Event



H. J. Thim Trust's  
**Theem College of Engineering, Boisar**  
 [Name of the Department]

**Minutes of Meeting**

Date: <u>29/12/18</u>	Location: <u>MPC LAB</u>
Time: <u>12</u> AM/PM	.
Called By: <u>Arbija Shaikh</u>	
Timekeeper: <u>1.00</u> Hrs	Note Taker: <u>—</u>
Submitted by (Name & sign): <u>Arbija Shaikh</u>	

**Attendees:**

Sr. No	Name of Faculty/ Non-Teaching Faculties	Sign
1	<u>Arbija Shaikh</u>	
2	<u>Geetha Tade</u>	
3	<u>Shakti Anand</u>	
4		
5		
6		
7		
8		
9		
10		
11		
12		

**Agenda of Meeting:**

**Presenter**

Student Coordinator : (Balanced team from Diploma & Degree)

1. Circulate the Link on various students group for participation along with the schedule.
2. Discuss & prepare the requirement sheet.
3. Judges Requirement in the format provided to you in Google sheet submit the same in Hard copy to Cultural Coordinator
4. Initial work distribution of the identified work (Note: Everyone has to give the best to make the event grand success but for simplicity we are distributing the task among all the coordinators. Distributing work does not mean he/she won't participate in other task of the event.)

Arbija Shaikh

Coordinator

Arbija Shaikh



PRINCIPAL  
 THEEM COLLEGE OF ENGINEERING  
 14, Village Boregaon, Boisar Chithar Road,  
 Boisar (East) Tal. & Dist. Palghar - 407 501.



H. J. Thim Trust's  
**Theem College of Engineering, Boisar**  
 Drama Event

**Minutes of Meeting**

Date: 07/10/19 Location: MTRX LAB  
 Time : 12 AM/PM  
 Called By: Shakir Hussain  
 Timekeeper: 30 min hrs Note Taker: -  
 Submitted by (Name & sign): Shakir Hussain

**Attendees:**

Sr.No	Name of Students	Branch/ Class	Contact No.	Sign
1	Shroeta Pawar	S.E. Elect Engg	9673343718	
2	Mohd. Umar	T.Y. Dip (Civil)	9975612359	
3	Saurabh Gharat	T.Y. Dip (Civil)	9823370854	
4				
5				
6				
7				
8				
9				
10				
11				
12				
13				

**Agenda of Meeting:**

1. Discuss about Poster preparation
2. General Discussion on Auction Theme
- 3.
- 4.

Presenter

*Shakir Hussain*

Prof. Drama Coordinator  
 Shakir Hussain



PRINCIPAL  
 THEEM COLLEGE OF ENGINEERING  
 Village Bhegaon, Boisar Taluk, Dist. Palghar - 407 502



H. J. Thim Trust's  
**Theem College of Engineering, Boisar**  
 Approved by AICTE (New Delhi), Government of Maharashtra and DTE  
 Affiliated to University of Mumbai

**Jashn-E-Theem 2K19**

Requirment Slip

Date: 09/01/19

Time: \_\_\_\_\_

Event Name: Drama

Staff Coordinator: 1) Arbiya Shaikh

Co- coordinators 2) Shahis Hussain ~~SL~~

3) Geetha Yadav

Particular	Finance (Amount in Rs)	Judges		
		Momento	Flower	Letter Head (Invitation & Thanksgiving)
Table Chair for Spot Entry- If needed	-			
Back Stage Cover	-			
Mask + Gloves	Rs. 400/-			
Bed	-			
↑				
Grand Total	400/-			

- Total six Grand Gloves were purchased and handed over to -

Sr. No	Award And Certificate			
	Coordinator	Participant		
	Appr. Certificate	Part. Certificate	Trophy	Medals
1	05	11	-	-
2	←	←	←	←
3	←	←	←	←

Event Coordinator  
 Name Arbiya Shaikh

Cultural Coordinator  
 Mr. Anzar Anemad Shaikh



*(Signature)*  
 PRINCIPAL  
 THEEM COLLEGE OF ENGINEERING  
 St. Village Borogani, Boisar Chikar B.  
 Boisar (East) Tal. & Dist. Palghar.



H.J. THEM TRUST'S  
THEEM COLLEGE OF ENGINEERING

presents

Drama Performance

"Act as if it were impossible to fail"

On 17<sup>th</sup> Jan 2019  
Venue: Main stage

Audition on Thursday, 10<sup>th</sup> Jan  
at 2:30 PM

Venue: 3<sup>rd</sup> floor Seminar Hall

Faculty

Coordinator:

- . Prof. Arbiya Shaikh  
7875417833
- . Prof. Geetha Yadur  
9284467855
- . Prof. Shakir Hussain  
9579105036



Student

Coordinator:

- . Umar (TY Civ)  
9975612359
- . Shweta (SE Elec)
- . Akash (SE Auto)  
7083296064
- . Saurabh (TY Civ)
- . Santosh (TE Auto)  
7977286873

PRINCIPAL

THEEM COLLEGE OF ENGINEERING  
At. Village Betegaon, Boisar Chithar Road,  
Boisar (East) Tal. & Dist. Palohar - 395 004



H. J. Thim Trust's  
**Theem College of Engineering, Boisar**  
 Approved by AICTE (New Delhi), Government of Maharashtra and DTE  
 Affiliated to University of Mumbai

**Jashn-E-Theem 2K19**

Sr. No	Participant/Rap. Name	Contact No.	Song/Theme	Time	Branch	Remark
<b>SINGING</b>						
	Saurabh Ghemal	9823370854	Tera Naam	4:15:00 PM ONWARDS		
	Shubham Patil	7066853982	Jeaye na Jaayene			
	Ajay Shikha	8169178669	Aayat			
	Pankaja Pimple	7738354517	Baba			
	Rakhi Jha	9545750834	moh moh ki dhage			
	Washi Shah	9271447791	Doina			
	Vinit Pujan	9823818738	Lea lehe Dil diye gale			
	Jaydeep	7798296623	Chunar			
	Shahinshah	8624878635	RAP			
<b>SPORTS PRIZE DISTRIBUTION</b>						
<b>DRAMA (Effect of Social Media on youth)</b>						
<b>DANCE</b>						
	Aniket & Bhavesh	9082447082	Koli Song	Group		
	Sona Yadav	7738667217	Diwani Mastani	Solo		
	Sakshi Singh	7507978218	Aafreen	Solo		
	Vivith Tare	9209223512	Simbha	Solo		
	Apeksha Nohwade	8788453596	Tribute to Madhuri	Solo		
	Rajshree Pachpande	7448015503	Sun Sathiya	Solo		
	Aniket & Reena	90822447082	Tujhe Reshmi Kale Baal	Group		
	Kapil Rathod	7021226525	Mix Song	Group		
	Bhavana Singh	8208267765	Tribute to Madhuri	Solo		
<b>DRAMA (Girls Education)</b>						
<b>SINGING &amp; DANCE PRIZE DISTRIBUTION</b>				7:00 PM		

Cultural Coordinator

Principal



*(Signature)*

**PRINCIPAL**

THEEM COLLEGE OF ENGINEERING  
 At Village Bategan, Boisar Taluka Palghar Dist. Maharashtra  
 Boisar (East) Tal. & Dist. Palghar - 401 301



**JASHN-E-THEEM**  
**2019**  
**SINGING COMPETITION**



**AUDITION**

ENTRY FEES:- 20 Rs.

DATE:- 10 JAN 2019

TIME:- 3 to 5 PM

VENUE:- IT CENTER, 1<sup>ST</sup> FLOOR ,MAIN BUILDING

**FINALS**

DATE:- 17 & 18 JAN 2019

TIME:- 3 PM ONWARDS

VENUE:- MAIN STAGE

**CO-ORDINATOR**

**STAAF**

ZULFIQUAR AHMAD(CIVIL) – 9923510075

JAYSHREE SALI(ELEC.) – 9284996588

SHOAIB SIR(DIP.MECH.) – 9768219633

**STUDENT**

RAJ SAVITA (SE-CIVIL) - 8208217957

JAYDEEP SHIYARA(BE-EXTC) - 7798296623

PAL SACHIN(DIP.TY.MECH) – 8600055461



  
**PRINCIPAL**  
THEEM COLLEGE OF ENGINEERING  
At: Village Betegaon, Borsar Chhitar (Dist. Patkura)  
Borsar (East) Tal. & Dist. Patkura

H. J. Thim Trust's

## Theem College of Engineering, Boisar

Approved by AICTE (New Delhi), Government of Maharashtra and DTE

Affiliated to University of Mumbai

### Jashn-E-Theem 2K19

#### Student Coordinator (Event Coordinator)

Name of Event Coordinator:

1. Zulfiquar Ahmad
2. Shoeb Khan
- 3.
4. Jayshrisali

Name of Event:

Singing

Date:

17 & 18 Jan 2019

Time:

3 PM onwards

Venue:

Main stage

Following is the List of Coordinators for the Event:

Sr. No	Name As required on certificate	Degree/Diploma	Branch & Class	Mobile No	Sign
1	Jay Deep Shiyara	Degree	BE EXC	7798296623	Ahemad
2	Raj savita	Degree	SE CIVIL	8208217957	Savita
3	Pat sachin	Diploma	TY MECH	8600055461	sachin

Cultural Coordinator  
Ansar Ahemad Shaikh  
Jashn-e-Theem - 2K19



*Zulfiquar Ahmad*  
Event Coordinator

PRINCIPAL  
THEEM COLLEGE OF ENGINEERING  
At Village Botegaon, Boisar Tal. Boisar, Dist. Palghar - 401 301

Cultural Event

# Singing

H. J. Thim Trust's  
**Theem College of Engineering, Boisar**  
 Approved by AICTE (New Delhi), Government of Maharashtra and DTE  
 Affiliated to University of Mumbai

## Jashn-E-Theem 2K19

Date: 17/11/2019  
 Time: 4.45 PM

Event Name: Singing

Name of Judge:

Contact Number:

Staff Coordinator: 1) Zulfiquar Ahmad  
 2)  
 3)

Sr. No.	Student Name	Branch & Year	10 Max Point(10)	10 Max Point(10)	10 Max Point(10)	Max Point(10)	30 Max Point(10)	Result Max Point(10)	Grand Total
		Set the Criteria Here	vocal	pitch	stage performance				
✓ 1	Saurabh Ghasat	TY civil	4	3	4	8	11		
✓ 2	Shubham patil	TY civil	5	5	6	-	16		
✓ 3	Ajay Shiroke	TE comp	8	7	7	-	22		
✓ 4	pratiksha ping	B-EE	4	4	3+1	-	12		
✓ 5	Rakhi Tha	TE comp	7	6	6	-	19		
✓ 6	Washi Shah	SE Auto	7	7	7	-	21		
✓ 7	Vinit puyary	SE Mech	7	6	5	-	18		
8	Shahin Shah		5	4	3		17		

TERE BINA ✓

  
 Judge  
 Date and Sign





PRINCIPAL  
 THEEM COLLEGE OF ENGINEERING  
 1st Village Boteagan, Boisar Tal. & Dist. Palghar - 40



H. J. Thim Trust's  
**Theem College of Engineering, Boisar**  
 Approved by AICTE (New Delhi), Government of Maharashtra and DTE  
 Affiliated to University of Mumbai

**Jashn-E-Theem 2K19**

Date: 17/01/19  
 Time:

Event Name: **SINGING**  
 Name of Judge: **K.N. Attarde**  
 Contact Number: **9987835598**  
 Staff Coordinator: 1) **Zulfiquar**  
 2)  
 3)

Sr. No.	Student Name	Branch & Year	Max Point(10)	Max Point(10)	Max Point(10)	Max Point(10)	Max Point(10)	Max Point(10)	Grand Total
Set the Criteria Here			Vocal	Pitch	Stage				
1	Saurabh Gharat	T.Y. CIVIL	6	6	6				18
2	Shubham patil	T.Y. CIVIL	8	8	8				24
3	Ajay Shirke	T.E. COMP	9	8+1	8				26
4	Pratiksha Pimple	B.E. IT	7	6	7				20
5	Rakhi Jha	T.E. COMP	6	6	6				18
6	Washi Shah	SE Auto	9	8	8				25
7	Vinit Pujary	SE MECH	8	8	8				24
8	Shahin Shah		7	5	4				16

①  
②  
③

Judge  
 Date and Sign

*(Signature)*  
 17/01/19



*(Signature)*

PRINCIPAL  
 THEEM COLLEGE OF ENGINEERING  
 Nr. Village Betgaon, Boisar Tal. Palghar Dist. Maharashtra - 401 301

**JASHN-E-THEEM**  
**2019**  
**SINGING COMPETITION**

**SELECTED PARTICIPANTS**

1. Shubham Patil
2. Rakhi Jha
3. Abhishek Yadav
4. Ajay Shirke
5. Vashi Shah
6. Vinit Poojary
7. Arsalan
8. Parag Bhosle
9. Pratiksha Pimple
10. Shehenshah Kale
11. Darshan Singhal
12. Shakshi Singh
13. Aukita Kudque
14. Saurabh Charat

Above participants are hereby informed to gather tomorrow.

Venue:- Seminar hall, 2<sup>nd</sup> floor

Time:- 11-01-2019 (3:00 PM)

Head  
Event co-ordinator  
*Anali*

Staff co-ordinator



*[Signature]*  
Observer

*[Signature]*

**PRINCIPAL**  
THEEM COLLEGE OF ENGINEERING  
At Village Behgaon, Boisar Chithar P.  
Boisar (East) Tal. & Dist. Palnhar.

H. J. Thim Trust's  
**Theem College of Engineering, Boisar**  
 Approved by AICTE (New Delhi), Government of Maharashtra and DTE  
 Affiliated to University of Mumbai

**Jashn-E-Theem 2K19**

Sr. No	Participant/Rep. Name	Contact No.	Song/Theme	Time	Branch	Remark
<b>SINGING</b>						
	Saurabh Gharat	9823370854	Tere Naam	4:15:00 PM ONWARDS		
	Shubham Patil	7066853982	Jaaye na Jaayena			
	Ajay Shirke	8169178869	Aayat			
	Paritksha Pimple	7738354517	Baba			
	Rakhi Jha	9545750834	moh moh k dhage			
	Washi Shah	9271447791	Doina			
	Vinit Pujari	9823818738	Laa Ishq/Dil diya galla			
	Jaydeep	7798296623	Chunar			
	Shahinshah	8624878635	RAP			
<b>SPORTS PRIZE DISTRIBUTION</b>						
<b>DRAMA (Effect of Social Media on youth)</b>						
<b>DANCE</b>						
	Apeksha Nalwade	8789453566	Tribute to Madhuri	Solo		
	Aniket & Bhavesh	9082447082	Koli Song	Group		
	Sona Yadav	7738667217	Diwani Mastani	Solo		
	Kapil Rathod	7021226525	Mix Song	Group		
	Bhavna Singh	8208267765	Tribute to Madhuri	Solo		
	Rajshree Pachpande	7448015503	Sun Sathiya	Solo		
	Aniket & Reena	90822447082	Tujhe Reshmi Kale Baal	Group		
	Sakshi Singh	7507978218	Aafreen	Solo		
	Vividh Tare	9209223512	Simbha	Solo		
<b>DRAMA (Girls Education)</b>						
<b>SINGING &amp; DANCE PRIZE DISTRIBUTION</b>				7:00 PM		

Cultural Coordinator



Principal

Dr. Aqueel Shah



**PRINCIPAL**  
 THEEM COLLEGE OF ENGINEERING  
 Village Boregaon, Boisar District - 401305  
 Dist. (East) Tal. & Dist. Palshur



H. J. Thim Trust's  
**Theem College of Engineering, Boisar**  
 Approved by AICTE (New Delhi), Government of Maharashtra and DTE  
 Affiliated to University of Mumbai

**Jashn-E-Theem 2K19**

Date: 17/01/2019

Time:

Event Name: Singing

Staff Coordinator: 1) Zulfiquar  
 2)  
 3)

Student Coordinator:

Sr. No.	Judge 1	Judge 2	Judge 3	Grand Total	Winners
1	26	22		48	Ajay Shirke
2	25	21		46	Washi Shah
3	24	18		42	Vinay Pujari
4					
5					
6					
7					
8					
9					

  
 Coordinator Sign & Name  
 Zulfiquar Ahmed

Cultural Coordinator Sign

**Mr. Ansar Ahemad Shaikh**



  
 PRINCIPAL

THEEM COLLEGE OF ENGINEERING  
 41, Village Betgaon, Boisar Taluk, Dist. Palghar - 401 301

"JASHN-E-THEEM 2K19"

# MEHENDI COMPETITION

Venue: AV Room above Library

Date: 10/01/2019

Time: 2.00PM

## Co-ordinators

TasneemAzam  
(Civil department)

SayaliMahajan (Extc)

RuchiRahi  
(Comp department)

## Student Co-ordinators

Jannat (7378626827)

(S.Y comp- diploma)

Mansi (7397903247)

Humera (8087575225)

Note: Mehendi cones will not be provided.

No entry fees



PRINCIPAL  
THEEM COLLEGE OF ENGINEERING  
At Village Botgaon, Bolser Chithar  
Bolser (East) Tal. & Dist. Pajhar







H. J. Thin Trust's  
**Theem College of Engineering, Boisar**  
 Approved by AICTE (New Delhi), Government of Maharashtra and DTE  
 Affiliated to University of Mumbai

**Jashn-E-Theem 2K19**

Date: 10/01/2019  
 Time: 2:00 pm.

Event Name: **Mehendi**  
 Name of Judge: **Jayashree Sali**  
 Contact Number: **9284996588**  
 Staff Coordinator: 1) **Tasneem Azam**  
 2) **Ruchi Rathi**  
 3) **Sayli Mahajan**

Sr. No.	Student Name	Branch & Year	Max Point(10)	Max Point(10)	Max Point(10)	Max Point(10)	Max Point(10)	Max Point(10)	Grand Total
Set the Criteria Here			length	design	creativity	clarity			
1)	Jannat sharth	DIP.SY.P	7	8	8	8	31		
2)	Pratyoti Gaikwad	Comp.TE	7	7	6	6			
3)	Swaroopa saurabhant	TE Comp	7	7	7	8			
4)	Ayasha Khan.	FE Comp	9	9	9	9	35		
5)	Sakshi Singh.	FE IT	6	6	5	5			
6)	Sabih Shaikh.	FE Comp	8	7	5	5			
7)	Utkarsha kinni	BE EXTC	7	8	7	7			
8)	Masuma Shaikh.	BE EXTC	9	7	7	7	36		
9)	Shanti Lade	T.Y. Comp	7	7	7	7			
10)	Humera Gilani	TE Comp	6	6	7	7			
11)	Shanti Patil	BE Comp	6	6	6	6			
12)	Blavika Gade	FE IT	6	5	6	5			

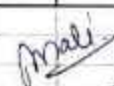
  
 Judge **Jayashree Sali**  
 Date and Sign  
 10/1/19



**PRINCIPAL**  
 THEEM COLLEGE OF ENGINEERING  
 11, Village Betgaon, Boisar, Taluka Boisar,  
 Dist. Palghar

H. J. Thim Trust's

## Theem College of Engineering, Boisar

Approved by AICTE (New Delhi), Government of Maharashtra and DTE  
Affiliated to University of Mumbai

### Jashn-E-Theem 2K19

Date: 10/01/2019

Time: 2:00 pm

Venue: Transportation  
Lab

Sr. No.	Name of the Participant/Group	Event (Dance, Singing & Mimicry)	Representative Mob. No.	Theme/Song Name/Dance Song	Remark, If any.
1	Humera Gilani	Mehendi	8446665513	T.E Comp	
2	Masuma Shaikh	Mehendi	9172143818	B.E Extc	
3	Utkasha Kini	Mehendi	9767994122	B.E Extc	
4	Shruti Lade	Mehendi	9503506481	T.Y. (dip) COMP.	
5	Shruti Pati	Mehendi	8805374127	T.Y. (dip) COMP.	
6					
7					
8					
9					
10					

Name & Sign of the Coordinators:

Cultural Coordinator  
Ansar Ahemad Shaikh  
Jashn-e-Theem - 2K19



PRINCIPAL  
THEEM COLLEGE OF ENGINEERING  
At Village Boregaon, Boisar Taluka B.  
Boisar (East Tal. & Dist. Palghar - 401 301)

Event Coordinator

Cultural Event

H. J. Thim Trust's

## Theem College of Engineering, Boisar

Approved by AICTE (New Delhi), Government of Maharashtra and DTE

Affiliated to University of Mumbai

### Jashn-E-Theem 2K19

#### Letter of Invitation for Jury Member

Date: 8/01/19

To,

Prof. Jayshree Sali

Department Electrical

It is with great pride that we ask for the honor of your presence as Jury Member for Nehandi Competition (Event name) at 10/01/19 (Date & Time) in A.V. room (Venue). 8:00 pm.  
Above Library.

With Regards,

Prof. Tasneem Azam Prof. \_\_\_\_\_ Prof. \_\_\_\_\_

Coordinator of the Event

Received:

J.Sali  
8/1/19

Name, Date & Sign

Jayshree Sali



PRINCIPAL  
THEEM COLLEGE OF ENGINEERING  
Village Biregaon, Boisar Chitler Road  
Boisar (East) Tal. & Dist. Palghar



Cultural Coordinator  
Ansar Ahemad Shalkh  
Jashn-e-Theem - 2K19

Ansar  
8/1/19  
Event Coordinator

Cultural Event



H. J. Thim Trust's  
**Theem College of Engineering, Boisar**  
 Approved by AICTE (New Delhi), Government of Maharashtra and DTE  
 Affiliated to University of Mumbai

**Jashn-E-Theem 2K19**

Date: 10/01/2019

Time: 2:00 p.m

Event Name: Mehendi

Staff Coordinator: 1) Tasneem Azam

2) Puchi Rahi

3) Sayli Mahajan

Student Coordinator: Jannat Shaikh, Manasee Ghasat

Sr. No.	Judge 1	Judge 2	Judge 3	Grand Total	Winners
1	MANSUMA SHAIKH		Extc	final year <sup>36</sup>	I <sup>st</sup>
2	AYESHA KHAN	Diplom	BY	computer <sup>35</sup>	II <sup>nd</sup>
3	JANNAT SHAIKH	Diploma	SY com	31	III <sup>rd</sup>
4					
5					
6					
7					
8					
9					

  
 Coordinator Sign & Name  
 Tasneem Azam

Cultural Coordinator Sign

**Mr. Ansar Ahemad Shaikh**





**PRINCIPAL**  
 THEEM COLLEGE OF ENGINEERING  
 St. Village Betegaon, Boisar Chimer P.  
 Boisar (East) Tal. & Dist. Palghar - 40

H. J. Thim Trust's

## Theem College of Engineering, Boisar

Approved by AICTE (New Delhi), Government of Maharashtra and DTE  
Affiliated to University of Mumbai

### Jashn-E-Theem 2K19

#### Observation and Remedy

Name of Event Coordinator: Tasneem Azam  
Name of Event: Mehendi Competition  
Following the issues which need to be addressed in the next year's Jashn-E-Theem

Observation	Remedy
<u>Clashes of the event-</u>	

#### Coordinators and Sign:

- Tasneem Azam
- Ruchi Rahi
- Sayali Mahajan



PRINCIPAL  
THEEM COLLEGE OF ENGINEERING  
Village Belegaon, Boisar Chikar Road  
Boisar (East) Tal. & Dist. Palghar

Cultural Coordinator  
Ansar Ahemad Shaikh  
Jashn-e-Theem - 2K19



Event Coordinator

Cultural Event





H. J. Thim Trust's  
**Theem College of Engineering, Boisar**  
 Approved by AICTE (New Delhi), Government of Maharashtra and DTE  
 Affiliated to University of Mumbai

**Jashn-E-Theem 2K19**

Requirment Slip Date: 3/1/19  
Time: 04:00 pm

Event Name: Best out of Waste  
 Staff Coordinator: 1) Ashraf Nabi  
 Co-coordinators 2) Kalamuddin Ansari  
 3) Vinay Sahu

Particular	Finance (Amount in Rs)	Judges		
		Memento	Flower	Letter Head (Invitation & Thanksgiving)
Table Chair for Spot Entry- If needed	02	/	/	/
Back Stage Cover	-			
Table for Performance	02			
<b>Grand Total</b>				

Sr. No	Award And Certificate			
	Coordinator	Participant		
	Appr. Certificate	Part. Certificate	Trophy	Medals
1	03	<del>03</del>	03	03
2				
3				

Ashraf Nabi  
 Event Coordinator  
 Name

  
 Cultural Coordinator  
**Mr. Anwar Anwar Shaikh**



  
**PRINCIPAL**  
 THEEM COLLEGE OF ENGINEERING  
 St. Village Bategaon, Boisar Chiplar P.O.  
 Tal. East Tal. & Dist. Palghar

H. J. Thim Trust's  
**Theem College of Engineering, Boisar**  
 Approved by AICTE (New Delhi), Government of Maharashtra and DTE  
 Affiliated to University of Mumbai

**Jashn-E-Theem 2K19**

Date: 14/07/2019  
 Time: 11:10 to 12:10 pm

Event Name: Best of out of waste  
 Name of Judge: Ehtesham Ahmad  
 Contact Number: 8446594098  
 Staff Coordinator: 1) Aghar Nahi  
 2) V. Pray Sahu  
 3) Kalamuddin Ansari

Sr. No.	Student Name	Branch & Year	Max Point(15)	Max Point(15)	Max Point(10)	Max Point(10)	Max Point(10)	Max Point(10)	Grand Total
Set the Criteria Here			Extenstion Utilization	Greenwater	Pract. Applied	Information Technology	Environment	Feasibility	
10	Prasanna Sasode	TE(Comp)	10	08	04	06	02	04	34
2	Ashish Jaiswal	TE(Mech)	06	06	02	03	02	02	21
3	Gram Aslam	BE	10	10	06	05	03	05	39
	Akash Dubey	(Civill)							
	Deepak Sawitri								
4	Ansari shahbaz	BE	13	13	08	10	04	05	53
	Md. Zulfakras Ali	(Civill)							
	Haniid Khan								
5	Sriniphil	BE	08	08	05	02	03	04	30
	Pathaikar	(exte)							
	Jawli Sankhe								
6	Julee Mallah	SE(exte)	05	04	03	00	03	03	18
7	Ankita Sankhe	SE(exte)	06	06	04	02	03	03	24
8	Aditi Bhow	TE(27)	10	12	08	07	04	03	44
9	Yogesh Samshi	TE	13	12	08	09	04	03	49
	Vivek Singh	(Mech)							
	Aqib Sheikh								
10	Khan Md Sameer	BE	08	06	06	04	03	04	31
	Khan Md Yashin	(Mech)							
11	Sagar R. Phadnis	TE(27)	04	04	04	00	02	04	18

I<sup>st</sup>

III<sup>rd</sup>  
II<sup>nd</sup>

E. Ahmad  
 14.07.19  
 Judge  
 Date and Sign



*(Signature)*

PRINCIPAL  
 THEEM COLLEGE OF ENGINEERING  
 M. Village Boregaon, Boisar Chitambar  
 Tal. (East) Tal. & Dist. Palghar - 41

H. J. Thim Trust's  
**Theem College of Engineering, Boisar**  
 Approved by AICTE (New Delhi), Government of Maharashtra and DTE  
 Affiliated to University of Mumbai

**Jashn-E-Theem 2K19**

Date: 14/01/2019  
 Time: 11:10 - 12:10 p.m

Event Name: Best out of waste  
 Name of Judge: Obaid ul Haque Ansari  
 Contact Number: 8149470180  
 Staff Coordinator:  
 1) Azhar Nahi  
 2) Vinay Sahu  
 3) Kalamuddin Ansari

Sr. No.	Student Name	Branch & Year	Max Point(10)	Max Point(15)	Max Point(10)	Max Point(10)	Max Point(5)	Max Point(5)	Grand Total
Set the Criteria Here			Extent of Utilization	Innovative	Practical Application	Technical Knowledge	Communication	Finishing	(60)
1.	Peesana Sasode	TE (Comp)	10	08	05	04	02	04	33
2.	Ashish Jaiswal	TE (Mech)	10	05	04	02	02	02	25
3.	Sram Aslam	BE (Civil)	12	10	08	04	02	03	39
	Akash Dubey								
	Deepak Sawta								
4.	Ansari Shahbaz	BE (Civil)	12	08	10	06	03	03	44
	Md. Zulfekar								
	Hamid Khan								
5.	Swapnil	BE	10	05	06	00	02	02	24
	Patilkar	(Elect)							
	Janvi Sankhe								
6.	Jules Mallah	SE (Mech)	08	05	04	00	03	02	22
7.	Ankal	SE	10	04	04	02	02	03	25
	Sankhe	(Elect)							
8.	Aditi Bhair	TE (IT)	10	09	08	07	02	03	39
9.	Ashish								
	Jaiswal								
9.	Yogesh	TE	10	13	08	08	03	02	44
	Vivek Singh	(Mech)							
	Aqub Shaikh								
10.	Shah Md Sameer	BE	09	05	04	00	02	03	27
	Khan Md Yamin	(Mech)							
11.	Sagar R. Bhawar	TEIT	07	04	02	00	02	02	17

Judge   
 Date and Sign 14/01/19



PRINCIPAL  
 THEEM COLLEGE OF ENGINEERING  
 At Village Bregoon, Boisar Taluka B...  
 Boisar (East Tal. & Dist. Palghar)



H. J. Thim Trust's

## Theem College of Engineering, Boisar

Approved by AICTE (New Delhi), Government of Maharashtra and DTE  
Affiliated to University of Mumbai

### Jashn-E-Theem 2K19

Date: 14.01.2019

Time: 11:10-12:10 Venue: BEE Lab

Sr. No.	Name of the Participant/Group	Event (Dance, Singing & Mimicry)	Representative Mob. No.	Theme/Song. Name/Dance Song	Remark, If any.
1	Priyana Sarode				
2	Ashish Jainwal				
3	Ibrahim Aslam. Akash Dubey, Deepak Sankh.				
4	Ansam Shahbaz. Md. Zulfikar Ali, Hamid Khan				
5	Sweptil Pathaskar. Jami Sankhe				
6	Julee Mallah				
7	Omkar Sankhe				
8	Aditi Bhow				
9	Yogesh Shamsher Vek Singh. Aaqib Shaikh				
10	Khan Md. Sameer. Khan Md. Yamin				

11. Sajid R. Bhavsar

Name & Sign of the Coordinators:

AZHAR NABE



Cultural Coordinator  
Ansam Ahmad Shaikh  
Jashn-e-Theem - 2K19



PRINCIPAL  
THEEM COLLEGE OF ENGINEERING  
At Village Betegaon, Boisar Taluk, Dist. Palghar - 401 301

Event Coordinator

Cultural Event



H. J. Thim Trust's

## Theem College of Engineering, Boisar

Approved by AICTE (New Delhi), Government of Maharashtra and DTE  
Affiliated to University of Mumbai

### Jashn-E-Theem 2K19

#### Circular

All the coordinators are requested to attend the meeting on  
1/1/2019. The detail of the meeting is given below.  
It is mandatory.

Date: 1/1/2019

Time: 10:30

Name of the Event: Rangoli

Venue: MM Lab e

With Regards,



PRINCIPAL

THEEM COLLEGE OF ENGINEERING  
St. Village Beteagan, Boisar Chitrad District  
Boisar (East) Tal. & Dist. Palghar - 401 201

Cultural Coordinator  
Ansar Ahemad Shaikh  
Jashn-e-Theem - 2K19

Event Coordinator

Cultural Event





H. J. Thim Trust's  
**Theem College of Engineering, Boisar**  
 [Name of the Department]

### Minutes of Meeting

Date: <u>29/12/18</u>	Location: <u>Programming Lab</u>
Time: <u>1:05 AM/PM</u>	
Called By: <u>Rosy Bhai</u>	
Timekeeper: <u>1</u> Hrs	Note Taker:
Submitted by (Name & sign): <u>fuchi kahi</u>	

**Attendees:**

Sr. No	Name of Faculty/ Non-Teaching Faculties	Sign
1	<u>Rosy Bhai</u>	<u>Rosy Bhai</u>
2	<u>fuchi kahi</u>	<u>fuchi kahi</u>
3	<u>Munali Kokate</u>	<u>Munali Kokate</u>
4		
5		
6		
7		
8		
9		
10		
11		
12		

**Agenda of Meeting:**

**Presenter**

Student Coordinator : (Balanced team from Diploma & Degree)

1. Circulate the Link on various students group for participation along with the schedule.
2. Discuss & prepare the requirement sheet.
3. Judges Requirement in the format provided to you in Google sheet submit the same in Hard copy to Cultural Coordinator
4. Initial work distribution of the identified work (Note: Everyone has to give the best to make the event grand success but for simplicity we are distributing the task among all the coordinators. Distributing work does not mean he/she won't participate in other task of the event.)

Coordinator



*[Signature]*

**PRINCIPAL**  
 THEEM COLLEGE OF ENGINEERING  
 at Village Belgaon, Boisar Chikar Road  
 Boisar (East) Tal. & Dist. Palghar - 401 301



H. J. Thim Trust's  
**Theem College of Engineering, Boisar**  
 Approved by AICTE (New Delhi), Government of Maharashtra and DTE  
 Affiliated to University of Mumbai

**Jashn-E-Theem 2K19**

Date: 16-1-2019  
 Time:

Event Name: Rangoli

Name of Judge:

Contact Number:

Staff Coordinator:

- 1) Ruchi Rahi
- 2) Rosy Bhoi
- 3) Marmala Kobate

SIZE CREAT: CLEAN COLOUR TOTAL 40

Sr. No.	Student Name	Branch & Year	Max Point(10)	Max Point(10) Creativity	Max Point(10) Clean	Max Point(10) Colour	Max Point(10) TOTAL	Max Point(10)	Grand Total
	Set the Criteria Here	Size	Creativity	Clean	Colour	TOTAL			
1			5	6	6	7	24		
2			7	8	7	7	29		
3			7	6	6	7	26		
4			6	8	6	6	26		
5			7	7	7	6	27		
6			5	5	6	6	22		
7			7	8	8	7	30		
8			7	8	5	5	25		
9			6	7	5	6	24		
10			6	7	8	6	27		
11			7	8	5	4	24		
12			7	7	5	7	26		

*[Signature]*  
 Judge  
 Date and Sign

- Size -
- Creativity -
- Cleaness -
- Colour combination -



*[Signature]*  
 PRINCIPAL  
 THEEM COLLEGE OF ENGINEERING,  
 At Village Belegaon, Boisar Chitaval Road,  
 Boisar (East Tal. & Dist. Palghar - 401 301)



H. J. Thim Trust's  
**Theem College of Engineering, Boisar**  
 Approved by AICTE (New Delhi), Government of Maharashtra and DTE  
 Affiliated to University of Mumbai

**Jashn-E-Theem 2K19**

Date: 16/11/19  
 Time: 10:00 to 11:30

Event Name: Rangoli  
 Name of Judge: Vinay Sahi  
 Contact Number:

- Staff Coordinator:
- 1) Ruchi Rathi
  - 2) Rosy Bhoir
  - 3) Murali Katakhe

Sr. No.	Student Name	Branch & Year	Max Point(10)	Max Point(10)	Max Point(10)	Max Point(10)	Max Point(10)	Max Point(10)	Grand Total
			Size	Color	Neatness	Creativity			
1)	2		5	5	6	6	-		22
2)	3		9	9	8	9			35
3)	4 - Gramosh		8	8	8	8			32
4)	5		9	9	9	9+1			37
5)	6		7	7	7	6			27
6)	7		7	8	7	8			30
7)	8		8	8	6	8			30
8)	9 Flag		8	8	6	9			31
	10		6	6	6	6			24
	11		7	7	7	8			28
	1		7	6	7	7			27
	12		7	7	7	7			28

  
 PRINCIPAL  
 THEEM COLLEGE OF ENGINEERING  
 At Village Belegaon, Boisar Tal. & Dist. Palghar - 401301

Judge  
 Date and Sign





H. J. Thim Trust's

## Theem College of Engineering, Boisar

Approved by AICTE (New Delhi), Government of Maharashtra and DTE

Affiliated to University of Mumbai

### Jashn-E-Theem 2K19

Rangoli

Date: 16/1/19

Time: 10:00

Venue: 1<sup>st</sup> floor/compt  
dept

Sr. No.	Name of the Participant/Group	Event (Dance, Singing & Mimicry)	Representative Mob. No.	Theme/Song. Name/Dance Song	Remark, If any.
1	Manasi Ghazrat				
2	Ashlesha Madkar				
3	Rashi Jamore				
4	Sayyoni Pagdhare				
5	Shruti Lade				
6	Apeksha				
7	Archana				
8					
9					
10					

Name & Sign of the Coordinators:



PRINCIPAL  
THEEM COLLEGE OF ENGINEERING  
At Village Betegon, Boisar Taluka, Dist. Palanpur - 401 201

Cultural Coordinator  
Ansar Ahemad Shaikh  
Jashn-e-Theem - 2K19

Event Coordinator  
Cultural Event



H. J. Thim Trust's  
**Theem College of Engineering, Boisar**  
 Approved by AICTE (New Delhi), Government of Maharashtra and DTE  
 Affiliated to University of Mumbai

**Jashn-E-Theem 2K19**

Date: 16/1/2019  
 Time: 10:00 to 11:30

Event Name: Rangoli

Staff Coordinator: 1) Ruchi Rathi  
 2) Rosy Bhoi  
 3) Anurajali Kokate

Student Coordinator:

Sr. No.	Judge 1	Judge 2	Judge 3	Grand Total	Winners
1	27	31	24	82	
2	<del>32</del>	31	29	82	
3	35	35	26	96	II <sup>nd</sup>
4	34	30	26	90	<del>III<sup>rd</sup></del>
5	37	34	27	98	I <sup>st</sup>
6	27	31	22	80	
7	30	28	30	88	
8	30	28	25	83	
9	33	38	24	95	III <sup>rd</sup> <i>12</i>
10	24	27	27	78	
11	28	29	24	81	
12	28	30	26	84	

Coordinator Sign & Name

Cultural Coordinator Sign  
 Mr. Ansar Ahemad Shaikh

I<sup>st</sup> - Archana Patil SE.IT  
 II<sup>nd</sup> - Bhavika Gode SE.IT  
 III<sup>rd</sup> - Manasi Ghavate s.r. Comp (Dip)



H. J. Thim Trust's

## Theem College of Engineering, Boisar

Approved by AICTE (New Delhi), Government of Maharashtra and DTE

Affiliated to University of Mumbai

### Jashn-E-Theem 2K19

#### Student Coordinator (Event Coordinator)

Name of Event Coordinator:

1. Kazi Azeemuddin
2. Sudhir Reddy
- 3.
- 4.

Name of Event:

Poster Painting

Date:

15/01/19.

Time:

11:00am.

Venue:

Drawing Hall.

Following is the List of Coordinators for the Event:

Sr. No	Name As required on certificate	Degree/ Diploma	Branch & Class	Mobile No	Sign
1	Rushi Kain Shind	Degree	FE Auto	9527520002	
2	Mahammed Omar	Dip.	Civil	9975612359	
3	Rajan Vishwakarma	Dip.	Civil	8698401322	
4	Mansi Gharat	Dip	Comp	7397903247	
5	Shaikh Jannat	Dip	Comp	7378626827	

Cultural Coordinator  
Ansar Ahemad Shaikh  
Jashn-e-Theem - 2K19



Event Coordinator

Cultural Event

PRINCIPAL  
THEEM COLLEGE OF ENGINEERING  
12, Village Bologan, Boisar, Chitrapur  
Dist. (East) Tal. & Dist. Paithan

H. J. Thim Trust's

## Theem College of Engineering, Boisar

Approved by AICTE (New Delhi), Government of Maharashtra and DTE

Affiliated to University of Mumbai

### Jashn-E-Theem 2K19

#### Circular

All the coordinators are requested to attend the meeting on  
poster painting The detail of the meeting is given below.  
It is mandatory.

Date: 08/01/19

Time: 11:15am.

Name of the Event: poster painting

Venue:

With Regards,



PRINCIPAL  
THEEM COLLEGE OF ENGINEERING  
M. Village Betegon, Boisar Chitran D.  
Boisar (East) Tal. & Dist. Palghar

  
Event Coordinator

Cultural Coordinator  
Ansar Ahemad Shaikh  
Jashn-e-Theem - 2K19

Cultural Event





H. J. Thim Trust's  
**Theem College of Engineering, Boisar**  
 [Name of the Department]

**Minutes of Meeting**

Date: 08/01/19 Location: Exam cell Diploma  
 Time : 11:15 AM/PM  
 Called By: Kazi Azeemodin.  
 Timekeeper: 1/2 Hrs Note Taker: Mansi Gherat.  
 Submitted by (Name & sign):

**Attendees:**

Sr. No	Name of Faculty/ Non-Teaching Faculties	Sign
1	Mansi Gherat.	
2	Sheikh Jannet	
3	Mohammed Umar	
4	Rajan Vishwakarma.	
5	Rushikesh Shinde.	
6		
7		
8		
9		
10		
11.		
12.		

**Agenda of Meeting:**

**Presenter**

Student Coordinator : (Balanced team from Diploma & Degree)

- ✓ 1. Circulate the Link on various students group for participation along with the schedule.
- ✓ 2. Discuss & prepare the requirement sheet.
- ✓ 3. Judges Requirement in the format provided to you in Google sheet submit the same in Hard copy to Cultural Coordinator
4. Initial work distribution of the identified work (Note: Everyone has to give the best to make the event grand success but for simplicity we are distributing the task among all the coordinators. Distributing work does not mean he/she won't participate in other task of the event.)

**PRINCIPAL**  
 THEEM COLLEGE OF ENGINEERING  
 At Village Bolegaon, Boisar Chitral P.  
 Boisar (East) Tal. & Dist. Palghar - 40

5) Take entries for poster.

Painting.

6) Make banner for event & rules for event.

Coordinator

7) venue - Drawing Hall.

8) Entry fees 20rs.



H. J. Thim Trust's  
**Theem College of Engineering, Boisar**  
 Approved by AICTE (New Delhi), Government of Maharashtra and DTE  
 Affiliated to University of Mumbai

**Jashn-E-Theem 2K19**

Requirment Slip

Date: 08/01/19.

Time: 4:00pm.

Event Name: Poster Painting

Staff Coordinator: 1) Kazi Azceemoddin S.

Co-coordinators 2) Sudhir Reddy,  
 3)

Particular	Finance (Amount in Rs)	Judges		
		Memento	Flower	Letter Head (Invitation & Thanksgivng)
Table Chair for Spot Entry- If needed	✓-	—	—	02
Back Stage Cover	—			
<u>Drawing Sheet (50)</u>	<u>500.</u>			
Grand Total				

Sr. No	Award And Certificate			
	Coordinator	Participant		
	Appr. Certificate	Part. Certificate	Trophy	Medals
1	✓	<u>33*</u>	✓	
2	✓		✓	
3	✓+02		✓	

Event Coordinator

Name Kazi A.S.

Cultural Coordinator

Mr. Ansar Ahemad Shaikh

\* Approx, may increase.



PRINCIPAL  
 THEEM COLLEGE OF ENGINEERING  
 St. Village Betegaon, Boisar Chittr Road  
 Boisar (East) Tal. & Dist. Palghar



H. J. Thim Trust's  
**Theem College of Engineering, Boisar**  
 Approved by AICTE (New Delhi), Government of Maharashtra and DTE  
 Affiliated to University of Mumbai

**Jashn-E-Theem 2K19**

Date: 15.1.19

Time: 3:00 pm.

Event Name: Poster painting

Name of Judge: Emily Khosla

Contact Number:

Staff Coordinator: 1) Karji Azcermoddm.  
 2) Dudhir Reddy.  
 3)

Sr. No.	Student Name	Branch & Year	Max Point(10)	Max Point(10)	Max Point(10)	Max Point(10)	Max Point(10)	Max Point(10)	Grand Total
	Set the Criteria Here	<del>Theme</del>	<del>Theme</del>	<del>creativity</del>	<del>presentation</del>				30
1.	<u>Theme</u>								
1.	<u>SHAH.MD. SAMEER</u>	<u>BE Mech</u>	<u>10</u>	<u>09</u>	<u>10</u>				<u>29</u>
2.	<u>Behavika V. Gode</u>	<u>SEIT</u>	<u>09</u>	<u>09</u>	<u>09</u>				<u>27</u>
3.	<u>Manali Kiranbhai</u>	<u>Dip Comp</u>	<u>09</u>	<u>08</u>	<u>08</u>				<u>25</u>
4.	<u>Sayali Mhatre</u>	<u>Dip Comp</u>	<u>08</u>	<u>08</u>	<u>08</u>				<u>24</u>
5.	<u>Pradnya Patil</u>	<u>Ty Comp Dip</u>	<u>07</u>	<u>07</u>	<u>07</u>				<u>21</u>
6.	<u>Shruti Bhushan</u>	<u>Ty Dip Comp</u>	<u>07</u>	<u>06</u>	<u>06</u>				<u>19</u>
7.	<u>Kanishk Varsha</u>	<u>Ty Civil</u>	<u>06</u>	<u>06</u>	<u>05</u>				<u>17</u>
8.	<u>Kaivalya Mahid</u>	<u>Mech</u>	<u>05</u>	<u>05</u>	<u>05</u>				<u>15</u>

E. Khosla  
 Judge  
 Date and Sign 15.1.19



PRINCIPAL  
 THEEM COLLEGE OF ENGINEERING  
 M. Village Bolegan, Boisar Chhattri Rd.  
 Boisar (East) Tal. & Dist. Palghar - 401





H. J. Thim Trust's  
**Theem College of Engineering, Boisar**  
 Approved by AICTE (New Delhi), Government of Maharashtra and DTE  
 Affiliated to University of Mumbai

**Jashn-E-Theem 2K19**

Date: 15/1/19  
 Time: 3:00 pm

Event Name: POSTER COMPETITION  
 Name of Judge: A. KUMAR  
 Contact Number: 9975275902  
 Staff Coordinator: 1) Kargi Azeemoddin  
 2) Sudhir Reddy  
 3)

IE (MECH)  
 SEIT  
 SY-DIP  
 Comp. T  
 T.Y. DIP  
 Comp. T  
 T.Y. Civil  
 T.Y. Mech

Sr. No.	Student Name	Branch & Year	Max Point(10)	Max Point(10)	Max Point(10)	Max Point(10)	Max Point(10)	Max Point(10)	Grand Total
	Set the Criteria Here		Theme	Coordinating	Presentat	-	-	-	30
	SHAH M. SAMEER		9	9	9	-	-	-	27
	BHAVIKA V GORE		9	9	8	-	-	-	26
	MANALI KIRAN SHAIK		8	8	9	-	-	-	25
	Satyaki Sumit Mahabadi		8	8	7	-	-	-	23
	Pradnya Gayatri Kulkarni		7	7	7	-	-	-	21
	Shruti Bherkar		7	7	6	-	-	-	20
	Ganesh Vartha		5	8	7	-	-	-	20
	Kaivalya M. Kante		8	7	6	-	-	-	19

-5  
 -H  
 -LH

Judge [Signature]  
 Date and Sign 15/1/19

[Signature]

PRINCIPAL  
 THEEM COLLEGE OF ENGINEERING  
 St. Village Botogon, Boisar Cluster II  
 Tal. (East) Tal. & Dist. Palghar





# POSTER MAKING COMPETITION INSTRUCTIONS

- Acceptable tools of drawing / painting include pencil, crayon, water color, oil paint.
- Photographs, wires, and other 3D objects are not acceptable. The completed artwork must be on a flat piece of paper.
- The drawing / painting must not include words, national flags, or slogans.
- The drawing / painting must not represent any particular individual, organization, or brand name and must not depict any religious theme.
- Name, Class & Branch must be clearly mentioned on the back of poster in the English Language.
- No text (including theme title, name, etc) should be written on the front of the poster.



A handwritten signature in blue ink, appearing to be 'S. S. S.', written over a horizontal line.

**PRINCIPAL**

**THEEM COLLEGE OF ENGINEERING**  
At Village Betegaon, Boisar Chithar Road  
Boisar (East) Tal. & Dist. Palohar - 395 001



# Poster Painting competition

On 15<sup>th</sup> JANUARY 2019 at 11: 00am

**VENUE:**

**Drawing Hall First floor, Diploma building**

**Faculty coordinator:**

**Prof. Kazi Azeemoddin**

**Prof. Sudhir Reddy**

**Student Coordinators:**

**Manasi Gharat**

**Jannat Shaikh**

**Rushikesh Shinde (9527520002)**

**Mohammad Umar (9975612859)**

**Rajan Vishwakarma (8698401322)**



**ENTRANCE: 20 Rs**

A handwritten signature in blue ink, likely belonging to the Principal.

**PRINCIPAL**

**THEEM COLLEGE OF ENGINEERING**

At. Village Betegaon, Bosisar Chilhara Road,  
Bosisar (East) Tal. & Dist. Palohar - 301001

H. J. Thim Trust's

## Theem College of Engineering, Boisar

Approved by AICTE (New Delhi), Government of Maharashtra and DTE  
Affiliated to University of Mumbai

### Jashn-E-Theem 2K19

poster painting

Date: 15/01/19

Time: 11:00am.

Venue: Drawing Hall

Sr. No.	Name of the Participant/Group	Event (Dance, Singing & Mimicry)	Representative Mob. No.	Theme/Song. Name/Dance Song	Remark, If any.
1	Rawat shubham		7276057117	Nature	
2	SHAH MOHD SAMEER		8693878182	A Girls Dream	
3	Raut Harsh		91584547556	Nature	
4	sankhe Omkar		7219785424	Sunset	
5	Kazik Mhatre		9766530616	Savagrichita	
6	Kaivalya Kauli		8419981591	Onlines Addiction	
7	BHANIKA GODE		9823326854	epolkation	
8	Deepak Savita		7028726008	Scenery	
9	Shubham . M. Patil		7066853982	Beatbox	
10	shubham. Govilkar		9112447472	Girls child Sam	

Name & Sign of the Coordinators:

Kazi Azeezuddin 



PRINCIPAL  
THEEM COLLEGE OF ENGINEERING  
Village Bolegaon, Boisar Talhar Road,  
Boisar (East) Tal. & Dist. Palanpur - 41

Cultural Coordinator  
Ansar Ahemad Shaikh  
Jashn-e-Theem - 2K19



  
Event Coordinator

Cultural Event

H. J. Thim Trust's

## Theem College of Engineering, Boisar

Approved by AICTE (New Delhi), Government of Maharashtra and DTE

Affiliated to University of Mumbai

### Jashn-E-Theem 2K19

Date: 15/01/19

Time: 11:00am.

Venue: Drawing Hall

Sr. No.	Name of the Participant/Group	Event (Dance, Singing & Mimicry)	Representative Mob. No.	Theme/Song. Name/Dance Song	Remark, If any.
1	Ganesh Vartha		90306226 <sup>21</sup>	Wartipainting	
2	Manasi Ahamed.		7397909247	Save child girls	
3	Sabiha Shaikh		7387307710	Am Indian <del>Story</del>	Save Pres.
4	Pratyoti Gaikwad		9011197858	flood	
5	Shwanti Rade		9503506481	Indian song.	
6	Sayali Mhabe		1420992772	Save child girl.	
7	Pradnya Patil		9665813632	women empowerment	
8					
9					
10					

Name & Sign of the Coordinators:

Kaji Azemuddin.





PRINCIPAL  
THEEM COLLEGE OF ENGINEERING  
M. Village Betgaon, Boisar Cluster B  
Boisar (East) Tal. & Dist. Palghar.



Cultural Coordinator  
Ansar Ahemad Shaikh  
Jashn-e-Theem - 2K19

  
Event Coordinator

Cultural Event



H. J. Thim Trust's

# Theem College of Engineering, Boisar

Approved by AICTE (New Delhi), Government of Maharashtra and DTE  
Affiliated to University of Mumbai

## Jashn-E-Theem 2K19

### Letter of Invitation for Jury Member

Date: 15/01/19.

To,

Prof. Dr. Jyathi Kumari  
Department Humanities.

It is with great pride that we ask for the honor of your presence as Jury Member for Poster painting (Event name) at 15/01/19. (Date & Time) in Exam cell. (Venue).

With Regards,

Prof. Rajeev Agreem / Prof. \_\_\_\_\_ Prof. \_\_\_\_\_  
Coordinator of the Event

Received: A. Jyothi Kumari

Name, Date & Sign



PRINCIPAL  
THEEM COLLEGE OF ENGINEERING  
12, Village Belagach, Boisar Chittr Road,  
Boisar (East) Tal. & Dist. Palghar - 401 301

  
Cultural Coordinator  
Ansar Ahmad Shaikh



A. Jyothi Kumari  
Event Coordinator

H. J. Thim Trust's

# Theem College of Engineering, Boisar

Approved by AICTE (New Delhi), Government of Maharashtra and DTE  
Affiliated to University of Mumbai

## Jashn-E-Theem 2K19

### Letter of Invitation for Jury Member

Date: 15/01/19.

To,

Prof. Dr. A. Kumar.

Department chemistry.

It is with great pride that we ask for the honor of your presence as Jury Member for Poster painting (Event name) at 15/01/19. (Date & Time) in Exam cell (Venue).

With Regards,

Prof. Kazi Azamuddin. Prof. \_\_\_\_\_ Prof. \_\_\_\_\_  
Coordinator of the Event

Received:

A. Kumar 15/01/19

Name, Date & Sign

A. Shaikh  
Cultural Coordinator  
Anwar Ahemad Shaikh



[Signature]  
PRINCIPAL  
THEEM COLLEGE OF ENGINEERING  
At Village Brelgaon, Boisar Taluka, Dist. Palghar

[Signature]  
Event Coordinator

H. J. Thim Trust's

## Theem College of Engineering, Boisar

Approved by AICTE (New Delhi), Government of Maharashtra and DTE  
Affiliated to University of Mumbai

### Jashn-E-Theem 2K19

#### Letter of Invitation for Jury Member

Date: 15/01/19.

To,

Prof. Dr. Emily Ghosh.

Department Physics.

It is with great pride that we ask for the honor of your presence as Jury Member for Poster painting (Event name) at 15/01/19. (Date & Time) in Exam cell (Venue).

With Regards,

Prof. Kozi Azarnadekin. Prof. \_\_\_\_\_ Prof. \_\_\_\_\_

Coordinator of the Event

Received:

E. Whorn

E. Whorn . 15.1.19

Name, Date & Sign

  
Cultural Coordinator  
Ansar Ahemad Shaikh  
Jashn-e-Theem - 2K19



  
PRINCIPAL  
THEEM COLLEGE OF ENGINEERING  
St. Village Betegaon, Boisar, CA-401007  
Boisar (East) Tal. & Dist. Palghar

Event Coordinator

Cultural Event



H. J. Thim Trust's  
**Theem College of Engineering, Boisar**  
 Approved by AICTE (New Delhi), Government of Maharashtra and DTE  
 Affiliated to University of Mumbai

**Jashn-E-Theem 2K19**

Date: 15/01/19

Time: 3:00 pm.

Event Name: Poster Painting

Staff Coordinator: 1) Kazi Azceemoddin.  
 2) Sudhir Reddy.  
 3)

Student Coordinator: Mohammed Umar

Sr. No.	Judge 1	Judge 2	Judge 3	Grand Total	Winners
1	29	27	27	83	SHAH MOHD SAMEER
2	27	26	24	77	BHAVIKA GODE.
3	25	25	23	73	MANSI KIRANGHARA
4					
5					
6					
7					
8					
9					

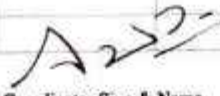
  
 Coordinator Sign & Name  
 Kazi A.S.

  
 Cultural Coordinator Sign

**Mr. Ansar Ahemad Shaikh**



  
**PRINCIPAL**  
 THEEM COLLEGE OF ENGINEERING  
 At Village Botogao, Boisar Taluka Boisar  
 Boisar (East) Tal. & Dist. Palghar - 401 301

H. J. Thim Trust's

## Theem College of Engineering, Boisar

Approved by AICTE (New Delhi), Government of Maharashtra and DTE  
Affiliated to University of Mumbai

### Jashn-E-Theem 2K19

#### Observation and Remedy

Name of Event Coordinator:

Kazi Azeemuddin.

Name of Event:

Poster Painting.

Following the issues which need to be addressed in the next year's Jashn-E-Theem

**Observation**

**Remedy**

clash in  
simultaneous  
events.

There should not be clashes  
among the various events.

#### Coordinators and Sign:

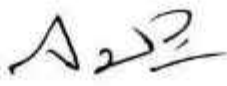
1. Kazi Azeemuddin. 

2.

3.

**Cultural Coordinator**  
Ansar Ahemad Shaikh  
Jashn-e-Theem - 2K19



  
**PRINCIPAL**  
THEEM COLLEGE OF ENGINEERING  
St. Village Betegaon, Boisar Chikher II  
Boisar (East) Tal. & Dist. Palghar

**Event Coordinator**

**Cultural Event**

H. J. Thim Trust's

## Theem College of Engineering, Boisar

Approved by AICTE (New Delhi), Government of Maharashtra and DTE  
Affiliated to University of Mumbai

### Jashn-E-Theem 2K19

#### Observation and Remedy

Name of Event Coordinator:

Kazi Azeemuddin

Name of Event:

Poster Painting

Following the issues which need to be addressed in the next year's Jashn-E-Theem

Observation	Remedy
clash in simultaneous events.	There should not be clashes among the various events.

#### Coordinators and Sign:

1. Kazi Azeemuddin. 
- 2.
- 3.



PRINCIPAL  
THEEM COLLEGE OF ENGINEERING  
St. Village Betgaon, Boisar Chikar P.  
Boisar (East) Tal. & Dist. Palghar.

Cultural Coordinator  
Ansar Ahemad Shaikh  
Jashn-e-Theem - 2K19



Event Coordinator

Cultural Event



File Doc. Seq. No	Event/Document	5 Mahendi			Cultural Coord. Sign
		Schedule Date	Submitted Date	Status	
1	Faculty Coord.	26/12/2018			
2	Student Coord	29/12/2018			
3	Meeting 0 agenda + Meeting Circular	29/12/2018	29/12/2018	Done	<i>[Signature]</i>
4	Work Distribution	29/12/2018	29/12/18	Done	<i>[Signature]</i>
5	Requirment	29/12/2018	-	-	
6	Judges Requirement	29/12/2018	26/01/19	Done	<i>[Signature]</i>
7	Evaluation Sheet		16/01/19	Done	<i>[Signature]</i>
8	Evaluation Parameter		16/01/19	Done	<i>[Signature]</i>
9	Poster & Phamplet		10/01/19	Done	<i>[Signature]</i>
10	Participant List		16/01/19	Done	<i>[Signature]</i>
11	Judges Invitation		15/01/19	Done	<i>[Signature]</i>
12	Execution Seq.				<i>[Signature]</i>
13	Final Winner List		16/01/19	Done	<i>[Signature]</i>
14	Closure Report [1]				
15	Expenditure Bills				<i>[Signature]</i>
16	Observation & Remedy		18/01/19	Done	<i>[Signature]</i>
17	Photo of the Event		18/01/19	Done	<i>[Signature]</i>



PRINCIPAL  
THEEM COLLEGE OF ENGINEERING  
St. Village Betegann, Bolzak Chikar B-1  
Chikar (East) Tal. & Dist. Palah w. J.K.



H. J. Thim Trust's

## Theem College of Engineering, Boisar

Approved by AICTE (New Delhi), Government of Maharashtra and DTE  
Affiliated to University of Mumbai

### Jashn-E-Theem 2K19

#### Circular

All the coordinators are requested to attend the meeting on 29/12/2018  
at 3:00 PM. The detail of the meeting is given below.  
It is mandatory.

Date: 29/12/2018

Time: 3:00 PM

Name of the Event: Floral Decoration Event

Venue: Staff Room (Mechanical)

With Regards,



PRINCIPAL  
THEEM COLLEGE OF ENGINEERING  
M. Village Betgaon, Boisar Tal. & Dist. Palghar

Event Coordinator

Cultural Event

Cultural Coordinator  
Ansar Ahemad Shaikh  
Jashn-e-Theem - 2K19





H. J. Thim Trust's  
**Theem College of Engineering, Boisar**  
 [Name of the Department]

### Minutes of Meeting

Date: <u>29/12/2018</u>	Location: <u>CAB LAB-2</u>
Time : <u>12 AM/PM</u>	
Called By: <u>Tejal D. Raut</u>	
Timekeeper: <u>    </u> Hrs	Note Taker:
Submitted by (Name & sign): <u>Tejal Dinkar Raut</u>	

**Attendees:**

Sr. No	Name of Faculty/ Non-Teaching Faculties	Sign
1	<u>Tejal Dinkar Raut</u>	<u>[Signature]</u>
2	<u>Jayesh Pratik Raut</u>	<u>[Signature]</u>
3		
4		
5		
6		
7		
8		
9		
10		
11		
12		

**Agenda of Meeting:**

**Presenter**

Student Coordinator : (Balanced team from Diploma & Degree)

1. Circulate the Link on various students group for participation along with the schedule.
2. Discuss & prepare the requirement sheet.
3. Judges Requirement in the format provided to you in Google sheet submit the same in Hard copy to Cultural Coordinator
4. Initial work distribution of the identified work (Note: Everyone has to give the best to make the event grand success but for simplicity we are distributing the task among all the coordinators. Distributing work does not mean he/she won't participate in other task of the event.)

[Signature]  
 29/12/2018  
 Coordinator



[Signature]  
 PRINCIPAL  
 THEEM COLLEGE OF ENGINEERING  
 St. Village Betegon, Bolser Chikher B...  
 Dist. Palghar - 401 301

H. J. Thim Trust's  
**Theem College of Engineering, Boisar**  
 Approved by AICTE (New Delhi), Government of Maharashtra and DTE  
 Affiliated to University of Mumbai

**Jashn-E-Theem 2K19**

Requirment Slip

Date: 16/01/19

Time: 10:04 PM

Event Name: Floral Decoration Competition

Staff Coordinator: 1) Tajal D. Raut

Co-coordinators 2) Harini P. Raut

3)

Particular	Finance (Amount in Rs)	Judges		
		Memento	Flower	Letter Head (Invitation & Thankgiving)
Table Chair for Spot Entry- If needed	-	/	/	02
Back Stage Cover	-			
<b>Grand Total</b>				

Sr. No	Award And Certificate			
	Coordinator	Participant		
	Appr. Certificate	Part. Certificate	Trophy	Medals
1	02	03		1G, 1S + 1B
2				
3				

Tajal D. Raut  
 Event Coordinator  
 Name Tajal D. Raut

Cultural Coordinator  
**Mr. Ansar Ahemad Shaikh**



Ansar  
 PRINCIPAL  
 THEEM COLLEGE OF ENGINEERING  
 St. Village Betsgaon, Boisar Taluk, Dist. Palghar

H. J. Thim Trust's

## Theem College of Engineering, Boisar

Approved by AICTE (New Delhi), Government of Maharashtra and DTE  
Affiliated to University of Mumbai

### Jashn-E-Theem 2K19

#### Judges Requirement Performa (Event Coordinator)

Name of Event Coordinator:	Tejal D. Raut
Name of Event:	Floral Decoration Competition
Date:	16/01/19
Time:	4:00pm
Venue:	II <sup>nd</sup> floor
Required Number of Judges:	02

#### Judge Coordinator

1	Name	Affiliation	Mobile No	Remark
2	Avani Sankhe		7710023368	-
3	Sanketi Raut		8806877577	-
Sign Judge Coordinator				

CC to: (By Judge Coordinator after Judge's arrangement)

- 1) Event Coordinator
- 2) Cultural Head Coordinator



Cultural Coordinator  
Ansar Ahemad Shaikh

Jashn-e-Theem - 2K19

  
PRINCIPAL  
THEEM COLLEGE OF ENGINEERING  
12, Village Betgaon, Boisar (Dist. Palghar)

  
Event Coordinator

Cultural Event



H. J. Thim Trust's  
**Theem College of Engineering, Boisar**  
 Approved by AICTE (New Delhi), Government of Maharashtra and DTE  
 Affiliated to University of Mumbai

**Jashn-E-Theem 2K19**

Date: 16/01/19  
 Time: 4:00PM

Event Name:

Name of Judge: Sanket Raut

Contact Number: 8806877577

Staff Coordinator: 1) Tejal Raut  
 2) Tanvi Raut  
 3)

Sr. No.	Student Name	Branch & Year	Max Point(10)	Max Point(10)	Max Point(10)	Max Point(10)	Max Point(10)	Max Point(10)	Grand Total
	Set the Criteria Here		electrical	Rep	Comp	Contest			
1.	Poorna Sorode		7	7	8				22
2.	Iram Ganwadi		7	6	7				20
3.	Akash Dubey		6	6	7				19
4.	Jannet Shaikh		7	7	8				22
5.	Preeti Verma		7	8	6				21
6.	Shruti Lade		8	8	9				25
7.	Badhya Patil		8	7	7				22
8.	Umat Patil		6	7	6				19
9.	Siddharth		8	6	7				21

*[Signature]*

PRINCIPAL  
 THEEM COLLEGE OF ENGINEERING  
 Village Netodun, Boisar District  
 Boisar (East) Tal. & Dist. Palghar

*[Signature]*  
 Judge

Date and Sign



H. J. Thim Trust's  
**Theem College of Engineering, Boisar**  
 Approved by AICTE (New Delhi), Government of Maharashtra and DTE  
 Affiliated to University of Mumbai

**Jashn-E-Theem 2K19**

Date: 16/01/19  
 Time: 4:00 PM

Event Name:

Name of Judge: Awani Sankhe

Contact Number: 7710023368

Staff Coordinator: 1) Tejal Kant  
 2) Tanvi Kant  
 3)

Sr. No.	Student Name	Branch & Year	Max Point(10)	Max Point(10)	Max Point(10)	Max Point(10)	Max Point(10)	Max Point(10)	Grand Total	
Set the Criteria Here										
1.	Preema Sarode		7	7	8				22	II
2.	Iram Gawandi		7	7	7				21	
3.	Akash Dubey		7	7	6				20	
4.	Jannet Shaikh		7	8	7				22	
5.	Preeti Verma		7	7	6				20	III
6.	Shruti		8	8	8				24	I
7.	Pradya		8	7	7				22	
8.	Annat		6	7	6				19	
9.	Siddharth		7	7	7				21	



PRINCIPAL

THEEM COLLEGE OF ENGINEERING  
 At Village Boregaon, Boisar Chhatrapati  
 Boisar (East Tal. & Dist. Palghar)



Judge

Date and Sign



H. J. Thim Trust's

## Theem College of Engineering, Boisar

Approved by AICTE (New Delhi), Government of Maharashtra and DTE

Affiliated to University of Mumbai

### Jashn-E-Theem 2K19

Date: 16/01/2019

Time: 10:30 AM

Venue: 2nd floor

Sr. No.	Name of the Participant/Group	Event (Dance, Singing & Mimicry)	Representative Mob. No.	Theme/Song- Name/Dance Song	Remark, If any.
1	Purana Sarode	Floral	8007093081	Comps. (TE)	II
2	Joan Aslam Gowardhi Ahmed Hamid	—u—	8888134402	Civil (BE)	
3	Akash Dusey Anjali Shahbaz	—u—	8796323163	Civil (BE)	
4	Jannat Shaikh manosi. ghatak	—u—	7378626827	dip. comp SY	
5	Preeti Veema Jagnati Patil	—u—	9284771570	dip. comp SY	III
6	Shruti Lake Suyati Mahabre	—u—	9503506481	Comp dip. TE	I
7	Pradhya Patil Vishal Thakur	—u—	9763600668	Comp dip. TE	
8	Urnati Patil Apeksha Nalawade	—u—		TE Comp	
9					
10					

Name & Sign of the Coordinators:

Tejal Dinkar Rauf

Tarvi Prakash Rauf

*Tejal Dinkar Rauf*  
16/01/2019

*Tarvi Prakash Rauf*  
16/01/2019



PRINCIPAL  
THEEM COLLEGE OF ENGINEERING  
14, Village Betegaon, Boisar, Tal. Boisar, Dist. Palghar - 401 301

Cultural Coordinator  
Ansar Ahemad Shaikh  
Jashn-e-Theem - 2K19



*Tejal Dinkar Rauf*  
16/01/2019

Event Coordinator  
Cultural Event



H. J. Thim Trust's  
**Theem College of Engineering, Boisar**  
 Approved by AICTE (New Delhi), Government of Maharashtra and DTE  
 Affiliated to University of Mumbai

**Jashn-E-Theem 2K19**

Date: 16/01/19

Time: 10:00 AM

Event Name: Floral decoration.

Staff Coordinator: 1) Tejal Raut  
 2) Tanvi Raut

3)  
 Student Coordinator: Ansalan Shaikh & Dindayal Barisht

Sr. No.	Judge 1	Judge 2	Judge 3	Grand Total	Winners
1	25	24	-	49	I
2	22	22	-	44	II
3	21	20	-	41	III
4					
5					
6					
7					
8					
9					

  
 Coordinator Sign & Name  
 (Tejal Raut)

  
 Cultural Coordinator Sign  
 Mr. Ansalan Shaikh  
PRINCIPAL  
 THEEM COLLEGE OF ENGINEERING  
 At Village Beteqaon, Boisar Tal. & Dist. Palghar

1) Shruti Lade } T.Y. dip Comp  
 Sayali Mhatre }

2) Pooerna Sarode → T.E. COMP

3) Preeti Verma } S.Y. dip comp  
 Jagruti Patil }



H. J. Thim Trust's  
**Theem College of Engineering, Boisar**  
 Approved by AICTE (New Delhi), Government of Maharashtra and DTE  
 Affiliated to University of Mumbai  
**Jashn-E-Theem 2K19**

**Observation and Remedy**

Name of Event Coordinator: Tsjar D. Park  
 Name of Event: Final Decoration Competition

Following the issues which need to be addressed in the next year's Jashn-E-Theem

Observation	Remedy
(⊗) Events should not clash. (⊕) Scheduling must be proper	

**Coordinators and Sign:**

1. Tsjar D. Park
2. Tarini P. Park
- 3.



PRINCIPAL  
 THEEM COLLEGE OF ENGINEERING  
 At Village Beteagan, Boisar Chithar Road  
 Boisar (East) Tal. & Dist. Palghar - 401 301



Event Coordinator  
 Cultural Event



Cultural Coordinator  
 Ansar Ahemad Shaikh  
 Jashn-e-Theem - 2K19

H. J. Thim Trust's

# Theem College of Engineering, Boisar

Approved by AICTE (New Delhi), Government of Maharashtra and DTE  
Affiliated to University of Mumbai

## Jashn-E-Theem 2K19

### Circular

All the [Staff / Student] coordinators are requested to attend the meeting on \_\_\_\_\_ . The detail of the meeting is given below.

It is mandatory.

Name of the Event:

Date: 29/12/2018

Time: 12:00 PM

Venue: WE - Lab - (IT)

With Regards,

Prof. Faiz Mohd. Khan.

Coordinator of the Event

Note: Record the meeting on MoM Annexure.



PRINCIPAL  
THEEM COLLEGE OF ENGINEERING  
St. Village Betegaon, Boisar, Tal. Boisar,  
Dist. Palghar



Faiz Khan  
Event Coordinator  
29/12/18  
Cultural Event

Cultural Coordinator  
Ansar Ahemad Shaikh  
Jashn-e-Theem - 2K19





H. J. Thim Trust's  
**Theem College of Engineering, Boisar**  
 [Name of the Department]

**Minutes of Meeting**

Date: <u>29-12-18</u>	Location: <u>WE Lab (IT)</u>
Time: <u>12:00 AM/PM</u>	
Called By: <u>Prof Faiz m Khan</u>	
Timekeeper: <u>1:00 Hrs</u>	Note Taker: _____
Submitted by (Name & sign): _____	

**Attendees:**

Sr. No	Name of Faculty/ Non-Teaching Faculties	Sign
1	Faiz m Khan	
2	Bhupanka Patil	
3	Snehal Pawate	
4		
5		
6		
7		
8		
9		
10		
11		
12		

**Agenda of Meeting:**

- Student Coordinator : (Balanced team from Diploma & Degree)
1. Circulate the Link on various students group for participation along with the schedule.
  2. Discuss & prepare the requirement sheet.
  3. Judges Requirement in the format provided to you in Google sheet submit the same in Hard copy to Cultural Coordinator
  4. Initial work distribution of the identified work (Note: Everyone has to give the best to make the event grand success but for simplicity we are distributing the task among all the coordinators. Distributing work does not mean he/she won't participate in other task of the event.)

**Presenter**

1. Faiz m. Khan

Coordinator

29/12/2018



**PRINCIPAL**  
 THEEM COLLEGE OF ENGINEERING  
 At Village Betegeon, Boisar Ghilhera  
 Boisar (East Tal. & Dist. Palghar)





# LET'S DANCE IT OUT!

Co-ordinator:-

• Faculty

1. Prof. Faiz Khan 9157306697
2. Prof. Snehal Pawade 8149585212
3. Prof. Priyanka Dhande 9156867201

**DANCE SHOWDOWN**



**Audition:- 10 JAN**

**Venue: Dip Drawing Hall**

• Students

1. Mohit Pandey (Dip) 8850464760
2. Khrishma Bari (Dip) 9156867201
3. Alisha Shaikh (Dip) 9156867201
4. Kapil Rathod (Deg) 7021226525
5. Anchal Tiwari (Deg) 8788924287
6. Sachin Singh (Deg) 7387444773
7. Sunny Gupta (Deg) 7276066761

**17 & 18 JAN 2019**

**Venue: Main Stage**

**Entry fees**

**Per head: 20/-**



**WIN WIN  
EXCITING HAMPERS**



PRINCIPAL  
THE JAIN COLLEGE OF ENGINEERING  
Village Baramulla, Baramulla District  
Jammu (East), Jammu & Kashmir



H. J. Thim Trust's  
**Theem College of Engineering, Boisar**  
 Approved by AICTE (New Delhi), Government of Maharashtra and DTE  
 Affiliated to University of Mumbai

**Jashn-E-Theem 2K19**

**Judges Requirement Performa**  
 (Event Coordinator)

Name of Event Coordinator:	Prof. Fariz M Khan, Prof. Snehal, Prof. Priyanka
Name of Event:	Dance
Date:	17 & 18 Jan 2019
Time:	Evening
Venue:	main stage
Required Number of Judges:	02

**Judge Coordinator**

	Name	Affiliation	Mobile No	Remark
1				
2				
3				
Sign Judge Coordinator				

CC to: (By Judge Coordinator after Judge's arrangement)

- 1) Event Coordinator
- 2) Cultural Head Coordinator

**Cultural Coordinator**  
 Ansar Ahemad Shaikh

Jashn-e-Theem - 2K19



  
**PRINCIPAL**  
 THEEM COLLEGE OF ENGINEERING  
 M. Village Boragaon, Boisar (Dist. Palghar)

  
**Event Coordinator**

**Cultural Event**







H. J. Thim Trust's  
**Theem College of Engineering, Boisar**  
 Approved by AICTE (New Delhi), Government of Maharashtra and DTE  
 Affiliated to University of Mumbai

**Jashn-E-Theem 2K19**

Date: ~~17-01-19~~ 17-01-19

Time: 4:00pm

Event Name: ~~Quiz~~ Dance (solo)

Staff Coordinator: 1) Faiz Mohd. Khan  
 2) Priyanka Dhande  
 3) Snehal Patil

Student Coordinator: Mohit, Kafil.

Sr. No.	Judge 1	Judge 2	Judge 3	Grand Total	Winners
1	<del>32</del> 32	32	—	64	Winner
2	32	30	—	62	2nd Runner-up
3	31	28	—	59	
4	29	32	—	61	
5	27	30	—	57	
6	32	31	—	63	1st Runner-up
7					
8					
9					

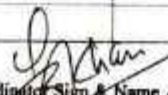
  
 Coordinator Sign & Name  
 Faiz Mohd. Khan

Cultural Coordinator Sign

Mr. Ansar Ahemad Shaikh



**PRINCIPAL**  
 THEEM COLLEGE OF ENGINEERING  
 At Village Belogao, Boisar Taluka Palghar Dist. Maharashtra - 401 301



H. J. Thim Trust's  
**Theem College of Engineering, Boisar**  
 Approved by AICTE (New Delhi), Government of Maharashtra and DTE  
 Affiliated to University of Mumbai

**Jashn-E-Theem 2K19**

Date: ~~17-01-19~~ 17-01-19  
 Time: 4:00pm

Event Name: ~~Quiz~~ Dance (Group)  
 Staff Coordinator: 1) Faiz Mohd. Khan  
 2) Priyanka Dhande  
 3) Snehal Patil  
 Student Coordinator: Mohit, Kafil.

Sr. No.	Judge 1	Judge 2	Judge 3	Grand Total	Winners
1	25	28	—	53	1st Runner up
2	27	29	—	56	Winner
3	26	26	—	52	2nd Runner up
4					
5					
6					
7					
8					
9					

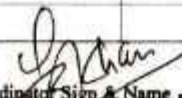
  
 Coordinator Sign & Name  
 Faiz Mohd. Khan

Cultural Coordinator Sign

**Mr. Ansar Ahemad Shaikh**



PRINCIPAL  
 THEEM COLLEGE OF ENGINEERING  
 St. Village Betegaon, Boisar Chimer Road  
 Boisar (East) Tal. & Dist. Palghar - 401 301



H. J. Thim Trust's  
**Theem College of Engineering, Boisar**  
 Approved by AICTE (New Delhi), Government of Maharashtra and DTE  
 Affiliated to University of Mumbai

**Jashn-E-Theem 2K19**

Date: ~~17-01-19~~ 17-01-19

Time: 4:00pm

Event Name: ~~Quiz~~ Dance

Staff Coordinator: 1) Faiz Mohd. Khan  
 2) Priyanka Dhande  
 3) Snehal Patil

Student Coordinator: Mohit, Kapil.

Sr. No.	Judge 1	Judge 2	Judge 3	Grand Total	Winners
1	25	28		(53)	1st Runner up (Group)
2	32	32		(64)	Winner (Solo)
3	32	30		(62)	2nd Runner up (Solo)
4	31	28		59	
5	29	32		61	
6	27	30		57	
7	27	29		(56)	Winner (Group)
8	26	26		(52)	2nd Runner up (Group)
9	32	31		(63)	1st Runner up (Solo)

Coordinator Sign & Name

*Faiz M Khan*

Cultural Coordinator Sign

Mr. Ansar Ahemad Shaikh





H. J. Thim Trust's

# Theem College of Engineering, Boisar

Approved by AICTE (New Delhi), Government of Maharashtra and DTE  
Affiliated to University of Mumbai

## Jashn-E-Theem 2K19

### Letter of Invitation for Jury Member

Date: 17-01-2019

To,

Prof. Geeta Yadav  
Department 1st year DE

It is with great pride that we ask for the honor of your presence as Jury  
Member for Dance (Event name) at 4:30hr (Date & 17-01-19  
Time) in MAIN STAGE (Venue).

With Regards,

Prof. F.M. Khan Prof. Snehal Pawale Prof. Priyanka Dhanda  
Coordinator of the Event

Received: [Signature]

Geetha Yadav  
Name, Date & Sign  
[Signature]

[Signature]

PRINCIPAL  
THEEM COLLEGE OF ENGINEERING  
St. Village Betgaon, Boisar Chitambar Rd.  
Boisar (East) Tal. & Dist. Palghar - 401 301

[Signature]  
Cultural Coordinator  
Ansar Ahemad Shaikh  
Jashn-e-Theem - 2K19



[Signature]  
Event Coordinator  
Cultural Event

H. J. Thim Trust's

## Theem College of Engineering, Boisar

Approved by AICTE (New Delhi), Government of Maharashtra and DTE  
Affiliated to University of Mumbai

### Jashn-E-Theem 2K19

#### Letter of Invitation for Jury Member

Date: 17-01-2019

To,

Prof. Azizurrahman Sir

Department \_\_\_\_\_

It is with great pride that we ask for the honor of your presence as Jury

Member for Dance (Event name) at 4:30 PM (Date & 17-01-19  
Time) in Main Stage (Venue).

With Regards,

Prof. F.M. Khan Prof. Inkhal Pawal Prof. Priyanka Phande  
Coordinator of the Event

Received:

[Signature]  
17/1/2019  
Name, Date & Sign

[Signature]

PRINCIPAL  
THEEM COLLEGE OF ENGINEERING  
At Village Belegaon, Boisar Taluk Palghar Dist.  
Palghar (East) Tal. & Dist. Palghar

[Signature]  
Cultural Coordinator  
Ansar Ahemad Shaikh  
Jashn-e-Theem - 2K19



[Signature]  
Event Coordinator  
Cultural Event



# Theem College of Engineering



BOISAR (E), DIST. THANE

## Certificate of Appreciation

Awarded to

*Mr. Mess* Krupesh Shinde

*Course* Automobile *Year* T.E.

*actively Participated in conducting* JASHN-E-THEEM as Volley ball  
*in the year* 2019



14/01/2019

*Date*

*Co-ordinators*



**PRINCIPAL**

**THEEM COLLEGE OF ENGINEERING**  
At Village Betegaon, Boisar Chitler Road,  
Boisar (East) Tal. & Dist. Palnhar - 401 201



# Theem College of Engineering



BOISAR (E), DIST. THANE

## Certificate of Appreciation

Awarded to

Ms. Miss Shreyas Bagwe

Course Mechanical Year T.E.

actively Participated in conducting JASHN-E-THEEM as Tug of War  
in the year 2019



09/01/2019

Date

  
Co-ordinator



PRINCIPAL

THEEM COLLEGE OF ENGINEERING  
At Village Betegaon, Boisar Chillar Road,  
Boisar (East) Tal. & Dist. Palahar - 50



# Theem College of Engineering



BOISAR (E), DIST. THANE

## Certificate of Appreciation

Awarded to

No. 1111 Jayesh Navekar

Course Electrical Year S.E

actively Participated in conducting JASHN-E-THEEM as Box Cricket  
in the year 2019



10/01/2019

Date

Co-ordinator

Principal



PRINCIPAL

THEEM COLLEGE OF ENGINEERING  
At Village Betegaon, Boisar Chithar Road,  
Boisar (East) Tal. & Dist. Palohar - 401 201



# Theem College of Engineering



BOISAR (E), DIST THANE

## Certificate of Appreciation

Awarded to

To Miss Samiksha Patil

Course Civil Year T.E.

actively Participated in conducting JASHN-E-THEEM as Box Cricket Girls  
in the year 2019



10/01/2019

Date

Co-ordinators



PRINCIPAL

THEEM COLLEGE OF ENGINEERING  
At Village Betegaon, Boisar Chithar Road,  
Boisar (East) Tal. & Dist. Palghar - 401302

# Theem College of Engineering



BOISAR (E), DIST. THANE

## Certificate of Appreciation

Awarded to

Mr. Suraj Patil

Course Automobile Year S.E.

actively Participated in conducting JASHN-E-THEEM in Open Cricket  
in the year 2019



11/01/2019

Date

Co-ordinators



**PRINCIPAL**

**THEEM COLLEGE OF ENGINEERING**

At. Village Betegaon, Boisar Chithar Road,  
Boisar (East) Tal. & Dist. Palohar - 401 301.



# Theem College of Engineering



BOISAR (E), DIST. THANE

## Certificate of Appreciation

Awarded to

Mr. Name Sagar Bhavasar

Course Information Technology Year T.E.

actively Participated in conducting JASHN-E-THEEM as Badminton

in the year 2019



10/01/2019

Date

Co-ordinators



PRINCIPAL

THEEM COLLEGE OF ENGINEERING  
At Village Betegaon, Boisar Chithar Road,  
Boisar (East) Tal. & Dist. Palghar - Maharashtra - 401501



# Theem College of Engineering



BOISAR (E), DIST. THANE

## Certificate of Appreciation

Awarded to

Mr./Miss Aashutosh Kambl

Course Mechanical Year B.E.

actively Participated in conducting JASHN-E-THEEM as Foot ball

in the year 2019



11/01/2019

Date

Co-ordinator

Principal

PRINCIPAL

THEEM COLLEGE OF ENGINEERING

At Village Betegaon, Boisar Chithar Road

Boisar (East) Tal. & Dist. Palghar - 401304





# Theem College of Engineering



BOISAR (E), DIST. THANE

## Certificate of Appreciation

Awarded to

Ms. Miss Shweta Pawar

Course Electrical Year S.E.

actively Participated in conducting JASHN-E-THEEM as Drama

in the year 2019



18/01/2019

Date

Co-ordinator

Principal

PRINCIPAL

THEEM COLLEGE OF ENGINEERING  
At. Village Betegaon, Boisar Chithar Road,  
Boisar (East) Tal. & Dist. Palghar - 401 302



# Theem College of Engineering



BOISAR (E), DIST. THANE

## Certificate of Appreciation

Awarded to

Ms. Miss Jannat Shaikh

Course Computer Year S.E.

actively Participated in conducting JASHN-E-THEEM as Mehendi Competition  
in the year 2019



31/12/2018

Date

Co-ordinators



PRINCIPAL

THEEM COLLEGE OF ENGINEERING  
At Village Betegaon, Boisar Chikhar Road,  
Boisar (East) Tal. & Dist. Palghar - 401 301



# Theem College of Engineering



BOISAR (E), DIST. THANE

## Certificate of Appreciation

Awarded to

Mr. & Miss Omkar Sankhe

Course EXTC Year S.E.

actively Participated in conducting JASHN-E-THEEM as Best of Waste  
in the year 2019



14/01/2019

Date

Co-ordinators



PRINCIPAL

THEEM COLLEGE OF ENGINEERING  
At Village Betegaon, Boisar Chithar Road  
Boisar (East) Tal. & Dist. Palghar - 401 501



# Theem College of Engineering



BOISAR (E), DIST. THANE

## Certificate of Appreciation

Awarded to

Ms. Mrs. Saurabh Chawat

Course Civil

Year T.E.

actively Participated in conducting JASHN-E-THEEM as Singing

in the year 2019



17/01/2019

Date

Co-ordinators



PRINCIPAL

THEEM COLLEGE OF ENGINEERING  
At Village Betegaon, Boisar Chithar Road,  
Boisar (East) Tal. & Dist. Palghar - 401 501

# 2018-19

# INTER



**University of Mumbai**  
**Calendar for the Inter-Collegiate Tournaments 2018-19**

Sr. No.	Name Of The Events	Last Date For Preliminary Entry	Last Date For Detail Entry i.e. Name List	Date Of The Tournaments
1	Half Marathon (M & W)	01/09/2018	01/09/2018	08/09/2018
2	Table Tennis (M & W)	27/08/2018	27/08/2018	17/09/2018
3	Football (M & W)	27/08/2018	10/09/2018	24/09/2018
4	Badminton (M & W)	01/09/2018	01/09/2018	24/09/2018
5	Basket Ball (M & W)	01/09/2018	15/09/2018	24/09/2018
6	Hand Ball (M & W)	03/09/2018	21/09/2018	26/09/2018
7	Aquatic (M & W)	10/09/2018	10/09/2018	26/09/2018
8	Cross Country (M & W)	17/09/2018	17/09/2018	01/10/2018
9	Kabaddi (M* & W)	03/09/2018	24/09/2018	03/10/2018
10	Wrestling (M & W)	24/09/2018	24/09/2018	03/10/2018
11	Judo (M & W)	24/09/2018	24/09/2018	05/10/2018
12	Tennis (M & W)	01/10/2018	01/10/2018	05/10/2018
13	Volleyball (M* & W)	07/09/2018	01/10/2018	08/10/2018
14	Hockey (M & W)	27/09/2018	01/10/2018	08/10/2018
15	Archery (M & W)	01/10/2018	01/10/2018	08/10/2018
16	Kho-Kho (M* & W)	07/09/2018	03/10/2018	11/10/2018
17	Gymn.& Malkhamb (MW)	11/10/2018	11/10/2018	20/10/2018
18	Shooting (M & W)	06/10/2018	06/10/2018	20/10/2018
19	Weight Lifting (M & W)	06/10/2018	06/10/2018	20/10/2018
20	Best Physique (M)	06/10/2018	06/10/2018	20/10/2018
21	Boxing (M & W)	06/10/2018	06/10/2018	22/10/2018
22	Athletics (M & W)	01/10/2018	01/10/2018	26/10/2018
23	Cycling (M & W)	05/11/2018	05/11/2018	16/11/2018
24	Cricket (M* & W)	20/10/2018	17/11/2018	20/11/2018
25	Chess (M & W*)	01/11/2018	16/11/2018	26/11/2018
26	Squash (M & W)	05/11/2018	05/11/2018	26/11/2018
27	Ball-Badminton (M & W)	03/11/2018	17/11/2018	26/11/2018
28	Yoga (M & W)	16/11/2018	16/11/2018	30/11/2018
29	Fencing (M & W)	01/12/2018	01/12/2018	14/12/2018
30	Power Lifting (M & W)	21/12/2018	21/12/2018	05/01/2019
31	Tug-of-War (M & W)	21/12/2018	21/12/2018	05/01/2019
32	Taekwondo (M & W)	05/01/2019	05/01/2019	15/01/2019
33	Base Ball (M & W)	31/12/2018	14/01/2019	21/01/2019
34	Soft Ball (M & W)	31/12/2018	14/01/2019	23/01/2019
35	Carrom (M & W)	05/01/2019	05/01/2019	28/01/2019
36	Ascen.& Decend. (M& W)	15/01/2019	15/01/2019	02/02/2019

(\*-Tournament will be conducted on five zone basis & the dates of Inter-Zonal will be intimated after the zonal tournaments.

The provisional entries and detailed entries duly completed in the prescribed proforma must reach along with Xerox copies of payment of sports contribution & consolidated entry fees on or before 5.00 p.m. on the respective stipulated dates prescribed in the sports calendar 2018-19, otherwise they will not allow participating in the respective sports tournament/ competitions.

  
**PRINCIPAL**  
THEEM COLLEGE OF ENGINEERING  
M. Village Befegaon, Borisar Chikhar, D.  
Near (East) Tal. & Dist. Palghar - 407 001





H. J. Thim Trust's

# THEEM COLLEGE OF ENGINEERING

## NOTICE

Date: 31/7/2018

All students are hereby informed that who are interested for participating in **Football event** at university level and Reliance youth football tournament(RFYS) there will be selection Trials on Thursday (**2nd August 2018**).  
Be available on ground at **1:00pm Sharp**  
**(NOTE: Be Present with entire kit)**

Prof. Syed Tanzeem  
Sports Coordinator



Dr. N.K.Rana

Principal  
PRINCIPAL

THEEM COLLEGE OF ENGINEERING  
Bolisar (East), Tal. 3 Dist. Palghar-401 501

PRINCIPAL  
THEEM COLLEGE OF ENGINEERING  
At Village Betegzon, Bolisar Chikar, Tal. 3  
Dist. Palghar (East) Tal. & Dist. Palghar - 401 501

**UNIVERSITY OF MUMBAI**  
**SPORTS DEPARTMENT**  
**INTER COLLEGIATE FOOTBALL (MEN TEAM) TOURNAMENT 2018-19**  
 Date of Tournament : 24th September, 2018 Onwards.  
 Venue : Univesity Sports Pavilion, Marine Lines, Mumbai - 20.

**Quarter - One**

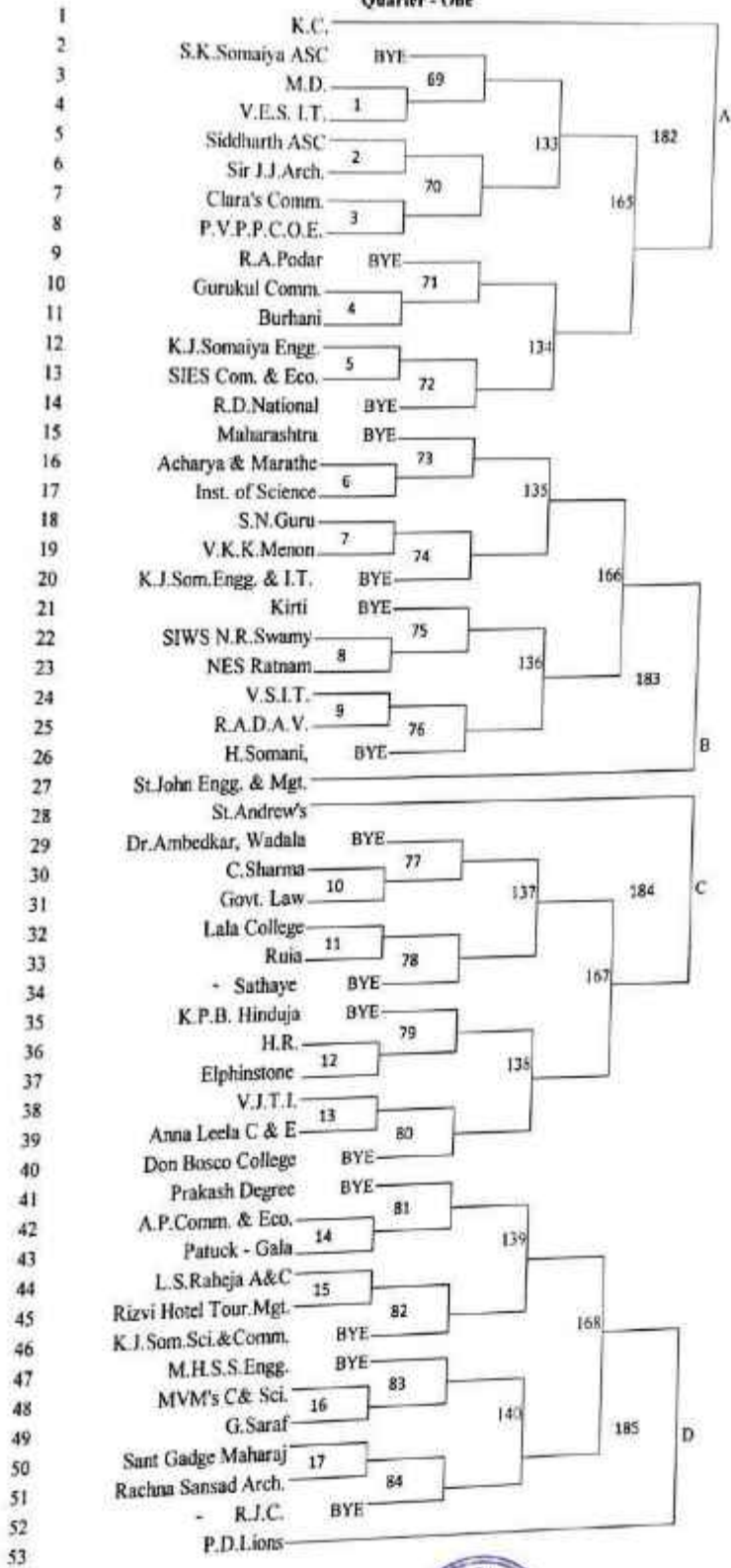

*(Signature)*

**PRINCIPAL**  
 THEEM COLLEGE OF ENGINEERING  
 M. Village, Borogam, Boisar, Chikar B.  
 Taluk (East) Tal. & Dist. Palghar - 407 507



Venue : Univesity Sports Pavilion, Marine Lines, Mumbai - 20.  
Quarter - Two

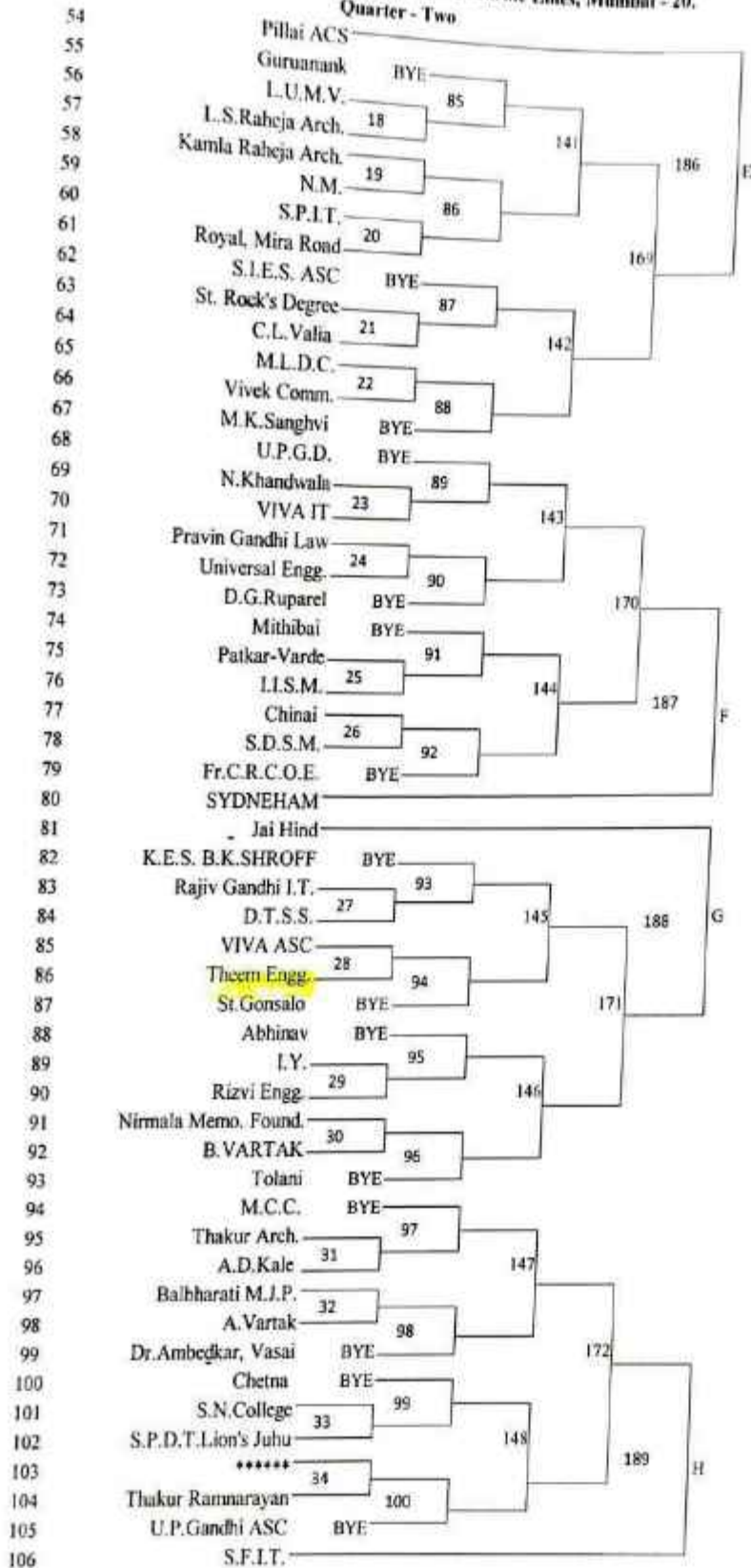

*(Signature)*

PRINCIPAL  
THEEM COLLEGE OF ENGINEERING  
St. Village Dehagan, Borser Chikar Road  
Solapur (East) Tel. & Dist. Solapur - 413 001



H. J. THIM TRUST'S

## THEEM COLLEGE OF ENGINEERING

### NOTICE

Date: 01/03/2023

All the students are hereby informed that, the college level Athletics (Boys and Girls) events will be starting from 9<sup>th</sup> March 2023. All the interested students should enroll your name as an Individual or Group on or before 3<sup>rd</sup> March 2023.

(Entry fees for Individual are Rs 10 and for Group /Team is Rs 40.)

Following Coordinators:-

ASIF (TE IT)

DANISH (SE AIML)

ANISH (TE COMP)

RITVIK(TE AIML)

#### Staff Coordinator

Prof. N G Hiremath

Prof. Harshad R.

Mr. Neetishkumar

Mrs. Sayali Patil

Mrs. Surekha Attarde

#### Sport Coordinator

Prof. Harshal Ahire

Prof. Ayaz Bagwan.



  
- PRINCIPAL  
THEEM COLLEGE OF ENGINEERING  
At Village Betagan, Bolsar Chikhar Road  
Bolzar (East) Tal. & Dist. Palghar - 401 501

TCOE / CST / 2019-20 / 101

Date: 13/09/2019

Ref No.:

To, Mr. Juned Shariff

Jt. Managing Director (Commercial)  
Niton Valve Ind. Pvt. Ltd. D-115 Ghatkopar Ind. Estate,  
L.B.S. Marg, Ghatkopar (W) Mumbai-400086

**Sub: Sponsorship for our "Student Football Team" at Theem College of Engg.**

Dear Sir,

**Theem College of Engineering** was started in the year 2009-10, with Degree and Diploma programs in Engineering. We have emerged as the only premier college in Boisar, Palghar Dist. with the overall intake of 720 students in various fields of Engineering situated about 90Km from Mumbai Central. Nestled amidst lush greenery, the campus celebrates the serene splendor of pristine nature. Spread across 10 acres, the college offers the perfect setting for an academic environment and Extra Co-curricular activities.

In the year **2018-19** our football team had played **4 different events** such as "University of Mumbai" Football League, "Reliance Youth Football sports" (RYFS) and "Palghar Dhanu Football Association League" (PDFA) and Jashn-e-Theem (Intra-College Event) which brought laurels to our college and displayed pristine characteristic for the individual players. And we also attained suitable positions in the preceding years.

Some of our player **Miss. Krushita Ambire (Third Year, Electrical)** represented **Palghar Dist Team** at "Western India Football Association" in June 2019, and was also a part of **JSW Football Club, Mr. Abdul Qadir (Final Year, Computer Science)** and **Mr. Tamdev Khairnar (Second Year, Civil)** is the National Level Player and participated in various state and national level events and have prospects to represent at various International level events very soon.

In this regard, we would be grateful to collaborate and fund the budding stars in the form of sponsorship at different categories Like **Platinum Sponsor** for front side Logo and Name of the sponsor organization, display banner of sponsor organization name with our college banner for **Rs. 50,000/-** and **Gold Sponsor** for backside Logo and name of the organization and display banner of sponsor organization name with our college banner for **Rs. 30,000/-**, both sponsors will be provided wide coverage in media during press meets banner (Print/Online/Social etc), and on college website and college magazine etc. Our students are active in other sports (Including Indoor and outdoor activities).

Payments should be done by account payee cheque only in favor of "**Theem Engineering Students Fund**" payable at Boisar.

In this regard, we would be grateful if your organization collaborates and provides the sponsorship as per the said details. Other details are available on our college website **www.theemcoe.org**. Further details can be provided on request.

Thanks and Regards,

  
Dr. N.K Rana  
Director



  
PRINCIPAL  
THEEM COLLEGE OF ENGINEERING  
M. Village Betegon, Boisar Taluk  
Boisar (East) Tal. & Dist. Palghar - 407 001



समता सहकारी बँक लिमिटेड  
SAMATA SAHAKARI BANK LIMITED  
717718 ADARSH NAGAR, OSHIWARAMUMBAI-400 102  
IFSC CODE - SRC60SAM001

VALID FOR THREE MONTHS  
29/11/2018  
D D M M Y Y Y Y

Finance & Accounts officer University of Mumbai

या धारक को ठेकार

रकम Twenty four thousand ninety six only

अदा करे

₹ 24,096/-

Ac.No 004200100003092

PSYD A/C only



*Arav*  
Theem College of Engineering  
(Please sign above)

291118 4000603501

10



*SP*  
PRINCIPAL  
THEEM COLLEGE OF ENGINEERING  
At Village Birtegaon, Boisar, Chikar B...  
Boisar (East) Tal. & Dist. Palghar

समता सहकारी बँक लिमिटेड  
SAMATA SAHAKARI BANK LIMITED  
717718 ADARSH NAGAR, OSHIWARAMUMBAI-400 102  
IFSC CODE : SRCB0SAM001

VALID FOR THREE MONTHS  
29 11 20 18  
D D M M Y Y Y Y

Finance & Accounts officer University of Mumbai

या धारक को Or Bearer

Twenty four thousand ninety six only

₹ 24,096/-

A/c.No 004200100003092

PSY'S A/C ONLY



*Away*  
Theem College of Engineering  
(Please sign above)

29 11 20 18 4000603500

10



*SP*

PRINCIPAL  
THEEM COLLEGE OF ENGINEERING  
M. Village Bategaon, Boksar District Palahar



Success... through  
quality education!

# Theem College of Engineering

Village Betegaon, Boisar Chilhar Road, Boisar (E), Tal. & Dist. Palghar - 401 501.  
Tel.: (02525) 284 909 ● Telefax : (02525) 284 927 ● Email : info@theemcoe.org ● Website : www.theemcoe.org

TCE/EST/2018-19/329

date: 07/12/18

To,  
The Director,  
Students welfare Department,  
V. V. Bhavan, 'B' Churchgate,  
Mumbai 20.

Sub :- Submission of Students Inter university sports & Cultural Activities  
Fees Academic Year 2018-2019.

Dear Sir,

With reference to above Subject our THEEM COLLEGE OF ENGINEERING  
Established during academic year 2009-2010 having following Eight branches now:

- 1) Computer Engineering - (60)
- 2) Electronics Engineering - (60)
- 3) Information Technology - (60)
- 4) Electronics & Tele communication Engineering - (60)
- 5) Mechanical Engineering - (120)
- 6) Civil Engineering - (60)
- 7) Electrical Engineering - (60)
- 8) Auto-Mobile Engineering - (60)

We have to pay Students Inter university sports & Cultural Activities Fees @ Rupees 24 per students of our college. We have enrolled 1004 students (Regular SE, TE & BE) during academic year 2018-2019 and the fee of Cultural Activities Rupees 24,096/- ( Twenty Four Thousand Ninty Six Only) payable in favour of 'Finance and Accounts Officer University of Mumbai' by Cheque number - 291148 Dated - 29/11/2018 Samata Sahkari Bank Limited, Oshiwara, Mumbai is enclosed.

Kindly acknowledge.

Thanking You,

PRINCIPAL  
THEEM COLLEGE OF ENGINEERING  
St. Village Betegaon, Boisar Chilhar E.  
Boisar (East) Tal. & Dist. Palghar



Yours Faithfully,

(Dr. N. K. Rana)  
Principal





# Theem College of Engineering

Village Betegaon, Boisar Chihar Road, Boisar (E), Tal. & Dist. Palghar - 401 501.  
Tel.: (02525) 284 909 ● Telefax: (02525) 284 927 ● Email: info@theemcoe.org ● Website: www.theemcoe.org

TCE/EST/2018-19/329

date: 07/12/18

To,  
The Director,  
Students welfare Department,  
V. V. Bhavan, 'B' Churchgate,  
Mumbai 20.

Sub :- Submission of Students Inter university sports & Cultural Activities  
Fees Academic Year 2018-2019.

Dear Sir,

With reference to above Subject our THEEM COLLEGE OF ENGINEERING  
Established during academic year 2009-2010 having following Eight branches now:

- 1) Computer Engineering - (60)
- 2) Electronics Engineering - (60)
- 3) Information Technology - (60)
- 4) Electronics & Tele communication Engineering - (60)
- 5) Mechanical Engineering - (120)
- 6) Civil Engineering - (60)
- 7) Electrical Engineering - (60)
- 8) Auto-Mobile Engineering - (60)

We have to pay Students Inter university sports & Cultural Activities Fees @ Rupees  
24 per students of our college. We have enrolled 1004 students (Regular SE, TE & BE)  
during academic year 2018-2019 and the fee of Cultural Activities Rupees 24,096/- ( Twenty  
Four Thousand Ninty Six Only) payable in favour of 'Finance and Accounts Officer  
University of Mumbai' by Cheque number - 291148 Dated - 29/11/2018 Samata Sahkari  
Bank Limited, Oshiwara, Mumbai is enclosed.

Kindly acknowledge.

Thanking You,

Yours Faithfully,

  
(Dr. N. K. Rana)  
Principal

  
PRINCIPAL  
THEEM COLLEGE OF ENGINEERING  
Village Betegaon, Boisar Chihar Road,  
Boisar (E), Tal. & Dist. Palghar - 401 501



M Gmail

Tanzeem Syed <tanzeem321@gmail.com>

Mon, Oct 15, 2018 at 3:11 PM

**RFYS Football - Mumbai Schedule Estimation**

rfysm: ni.football@gmail.com <rfysmumbai.football@gmail.com>  
To: tanzeem321@gmail.com

Dear Principal & Coach,

**THEEM COLLEGE OF ENGINEERING**  
(RFYS Institute Code: RFYSCLG00531)

Thank you very much for fielding your team in Reliance Foundation Youth Sports College Football 2018.

Please find below the schedule of **THEEM COLLEGE OF ENGINEERING** team's College Boys match.

**DATE: 16th October 2018**

**REPORTING TIME: 12:30:00 PM**

**ROUND: Qualifiers**

**VENUE: Poisar Gymkhana, Kandivali**

The schedule is subject to change. In case of any changes in the schedule, venue, timings, the updated schedule will be available on <http://www.rfyouthsports.com>.

For any further details, please call us on 9967338362.

We wish your team the very best of luck for the tournament.



**PRINCIPAL**  
**THEEM COLLEGE OF ENGINEERING**  
At Village Biregaon, Bolser Chikar P.  
Poisar (East) Tal. & Dist. Palghar - 407





# INSTITUTE

## REGISTRATION FORM

(2018-19)

### INSTITUTE DETAILS

Name\*: THEEM COLLEGE OF ENGINEERING  
 University / Board Affiliation\*: MUMBAI UNIVERSITY  
 Institute Registration Number\*: NO. AFP/RECOG/2609 of 2008 Pt-2  
 Address\*: VILLAGE BETEGAON, CHILHAR ROAD, BOISAR  
 City\*: BOISAR State\*: MAHARASHTRA  
 Pin\*: 402501  
 Contact No. \*: 02525-284909 Email\*: info@theemcoe.org

### INSTITUTE HEAD (PRINCIPAL/ DEAN)

Name\*: DR. N. K. RANA  
 Designation\*: PRINCIPAL  
 Contact No\*: 9833366487 Email\*: principal@theemcoe.org

### HEAD OF DEPARTMENT (SPORTS/ PE)

Name\*: SYED TANZEEM  
 Designation\*: ASST. PROFESSOR  
 Contact No\*: 9370156886 Email\*: tanzeem321@gmail.com  
tanzeem.syed@theemcoe.org

### TEAM CO-ORDINATOR (TEAM CAPTAIN/ SPORTS HEAD)

Name\*: Meet Mistry  
 Contact No\*: 9757021910 Email\*: meetmistry1988@gmail.com

### TEAM CO-ORDINATOR ( PARENT IN-CHARGE)

Name: \_\_\_\_\_  
 Contact No: \_\_\_\_\_ Email: \_\_\_\_\_

PRINCIPAL  
 THEEM COLLEGE OF ENGINEERING  
 St. Village Betegaon, Boisar Chilhar Road  
 Boisar (East) Tal. & Dist. Palghar - 402501





**SPORTS PARTICIPATING IN:**

FOOTBALL
Junior Boys [Class 7-10 student (born on or after July 1, 2002)]
Senior Boys [Class 11 or 12 student (Under 18 years, born on or after July 1, 2000)]
School Girls [Class 9-12 student (Under 18 years, born on or after July 1, 2000)]
College Boys [Undergraduate (Born on or after July 1, 1995 and below 23 years)]

PLEASE TICK YOUR CATEGORY:

<input type="checkbox"/>
<input type="checkbox"/>
<input type="checkbox"/>
<input checked="" type="checkbox"/>

ATHLETICS
Sub Junior Girls [Student of Class 7 -8 (Under 14 years, born on or after July1, 2004)]
Sub Junior Boys [Student of Class 7 -8 (Under 14 years, born on or after July1, 2004)]
Junior Girls [Student of Class 9 -10 (Under 16 years, born on or after July1, 2002)]
Junior Boys [Student of Class 9 -10 (Under 16 years, born on or after July1, 2002)]
Senior Girls [Student of Class 11 -12 (Under 18 years, born on or after July 1, 2000)]
Senior Boys [Student of Class 11 -12 (Under 18 years, born on or after July 1, 2000)]
College Girls [Undergraduate (Born on or after July 1, 1995 and below 23 years)]
College Boys [Undergraduate (Born on or after July 1, 1995 and below 23 years)]

PLEASE TICK YOUR CATEGORY:

<input type="checkbox"/>
<input type="checkbox"/>
<input type="checkbox"/>
<input type="checkbox"/>
<input type="checkbox"/>
<input type="checkbox"/>
<input type="checkbox"/>
<input checked="" type="checkbox"/>

\* Marked fields are mandatory

NAME: *Dr. D. K. Rane*

SIGNATURE: *[Handwritten Signature]*

STAMP: **PRINCIPAL**  
**THEEM COLLEGE OF ENGINEERING**  
 Boisar (East), Tal. & Dist. Palghar-401 501



*[Handwritten Signature]*

**PRINCIPAL**  
**THEEM COLLEGE OF ENGINEERING**  
 St. Village Betegaon, Boisar Chikar Tal.  
 Palghar (East) Tal. & Dist. Palghar - 401 501



\*For eligibility criteria in categories please refer to athlete registration forms.

Fixture updates from RFYS

Dear User,

Greeting from RFYS !

Please find below the fixture updates

Tournament: RFYS Football Mumbai Championship 2018-19

Fixture: **THEEM COLLEGE OF ENGINEERING** vs ST. ANDREWS  
COLLEGE, BANDRA WEST

Match Start Time: 13-10-2018 03:45:00 PM

Venue: Poinsur Gymkhana, Kandivali

Thanks,  
RFYS Team

Please contact us for any feedback or help.

 022 22787600



[registrations@rfyouthsports.com](mailto:registrations@rfyouthsports.com)

[www.rfyouthsports.com](http://www.rfyouthsports.com)

STAY CONNECTED



PRINCIPAL

THEEM COLLEGE OF ENGINEERING

At. Village Betegaon, Borsar Chitthar Road,  
Poinisar (East) Tal. & Dist. Palohar - 40





PRINCIPAL  
THEEM COLLEGE OF ENGINEERING  
At Village Betegaon, Bobsar Chilhaer Road,  
Bolsar (East) Tal. & Dist. Palohar - 40





**Fixture updates from RFYS**

Dear User,

Greeting from RFYS !

Please find below the fixture updates

Tournament: RFYS Football Mumbai Championship 2018-19

Fixture: THEEM COLLEGE OF ENGINEERING vs ST. ANDREWS  
COLLEGE, BANDRA WEST

Match Start Time: 13-10-2018 03:45:00 PM

Venue: Poinsur Gymkhana, Kandivali

Thanks,  
RFYS Team

Please contact us for any feedback or help.

 022 22787600



[registrations@rfyouthsports.com](mailto:registrations@rfyouthsports.com)

[www.rfyouthsports.com](http://www.rfyouthsports.com)

STAY CONNECTED



**PRINCIPAL**

**THEEM COLLEGE OF ENGINEERING**  
At. Village Betegaon, Boisar Chithar Road,  
Boisar (East) Tal. & Dist. Palohar - 401 301



# YOUTH SPORTS



Login

- ABOUT RFYS
- TOURNAMENT ZONE
- INSTITUTES
- NEWS
- CONTACT US

## FIXTURES & RESULTS

- MUMBAI
- PUNE
- CHENNAI
- LIVE**
- KOLKATA
- KOCHI
- GOA
- DELHI
- GUWAHATI

- ALL
- LIVE
- UPCOMING**
- RESULTS

Search Institute	ALL	JR BOYS	SR BOYS	SR GIRLS	COLLEGE	30 <sup>th</sup> AUG
------------------	-----	---------	---------	----------	---------	----------------------

30 Aug 2016 BOYS

Fr. Agnel, Vashi [QUALIFIERS ROUND 1]

St. Wilfred College **0** FT **2** Terna College

[MATCH CENTRE](#)

31 Aug 2016

Fr. Agnel, Vashi [QUALIFIERS ROUND 1]

J.K. College Of Science And Commerce **2** FT **1** Bharati Vidyapeeth College of Architecture

[MATCH CENTRE](#)

03 Sep 2016

Fr. Agnel, Vashi [QUALIFIERS ROUND 1]



PRINCIPAL

THEEM COLLEGE OF ENGINEERING  
 At Village Betagaon, Bolser Chittar B...  
 Bolsar (East) Tal. & Dist. Palghar

[MATCH CENTRE](#)



FT

Western College  
Of Commerce &  
Business  
Management

3

Pillais College  
Of Engineering

04 Sep 2016

0

St. Francis Ground, Borivali [QUALIFIERS ROUND 1]

MATCH CENTRE

Prakash Degree  
College

FT

0

Ghanshyamdas  
Saraf College

2

St. Francis Ground, Borivali [QUALIFIERS ROUND 1]

MATCH CENTRE

Sardar Patel  
Institute of  
Technology

FT

2

Kes Shroff  
College Of Arts  
& Science

1

11 Sep 2016

WALK OVER

St. Francis Ground, Borivali [QUALIFIERS ROUND 1]

MATCH CENTRE

Prahladarai  
Dalmia Lions  
College Of  
Comm & Eco.

3

Dr. Babasaheb  
Ambedkar  
College

0

St. Francis Ground, Borivali [QUALIFIERS ROUND 1]

MATCH CENTRE

Anandi Bai  
Damodar Kale  
College Of  
Commerce

FT

2

Theem College  
Of Engineering

1

12 Sep 2016

WALK OVER

Palava Football Stadium, Dombivli [QUALIFIERS ROUND 1]

MATCH CENTRE





UNIVERSITY OF MUMBAI INTER COLLEGIATE FOOTBALL  
TOURNAMENT 2018 - 2019



**ENTRY FORM FOR TEAM EVENT ONLY**

(To be submitted on or before the last date mentioned in the Sports Calendar.)

Name of the College & Code No.:  
THEEM COLLEGE OF ENGINEERING, 3222

Tel. No.: 02525-284909

Fax No.: \_\_\_\_\_

E-mail: tanzeem.syed@themcoe.org

The Director of Phy. Edu. & Sports,  
University of Mumbai,  
University Sports Pavilion,  
Marine Lines, Mumbai-400 020.

Sir,

I am please to inform you that my college will be participating in the FOOTBALL  
Tournament/s to be held during the current academic year. Our College has paid Annual Sports  
Contribution vide Cheque/DD.No. 015967 dated 2/2/2018 and Entry Fees vide  
Cheque/DD.No. \_\_\_\_\_ dated \_\_\_\_\_ to the University. If Sports  
Contribution/Entry Fee not paid the entry may be rejected.

✓  
MEN / WOMEN

Place: Boisar

Date: 2/8/18



  
PRINCIPAL  
PRINCIPAL  
THEEM COLLEGE OF ENGINEERING  
Boisar (East), Tal. & Dist. Palghar-401 501.  
(College Seal)

  
PRINCIPAL  
THEEM COLLEGE OF ENGINEERING  
At Village Belgaon, Boisar Chikhar Road,  
Boisar (East), Tal. & Dist. Palghar.

Note: PLEASE } Name Syed Tanzeem & Phone No. 9370156886 of any other  
STATE } responsible person from your College to contact him/her in case of emergency/  
HERE } urgency arises beyond normal working hours or on holidays.





UNIVERSITY OF MUMBAI INTER COLLEGIATE FOOTBALL  
TOURNAMENT 2018 - 2019



**ENTRY FORM FOR TEAM EVENT ONLY**

(To be submitted on or before the last date mentioned in the Sports Calendar.)

Name of the College & Code No.:  
THEEM COLLEGE OF ENGINEERING, 3222  
Tel. No.: 02525-284909  
Fax No.: \_\_\_\_\_  
E-mail: tanzeem.syed@themcoe.org

The Director of Phy. Edun. & Sports,  
University of Mumbai,  
University Sports Pavilion,  
Marine Lines, Mumbai-400 020.

Sir,

I am please to inform you that my college will be participating in the FOOTBALL  
Tournament/s to be held during the current academic year. Our College has paid Annual Sports  
Contribution vide Cheque/DD.No. 015967 dated 2/4/2018 and Entry Fees vide  
Cheque/DD.No. \_\_\_\_\_ dated \_\_\_\_\_ to the University. If Sports  
Contribution/Entry Fee not paid the entry may be rejected.

MEN /  WOMEN

Place: Boisar  
Date: 2/8/18



  
PRINCIPAL  
PRINCIPAL  
THEEM COLLEGE OF ENGINEERING  
Boisar (East), Tal. & Dist. Palghar-401 501.  
(College Seal)

PRINCIPAL  
THEEM COLLEGE OF ENGINEERING  
Village Bongan, Boisar Dist. Palghar  
Boisar (East) Tal. & Dist. Palghar

Note: PLEASE } Name Syed Tanzeem & Phone No. 9370156886 of any other  
STATE } responsible person from your College to contact him/her in case of emergency/  
HERE } urgency arises beyond normal working hours or on holidays.







H. J. THIM TRUST'S

# THEEM COLLEGE OF ENGINEERING

Approved By AICTE (New Delhi), Government of Maharashtra & DTE, Affiliated To University of Mumbai & MSBTE. Estd. 2009.

Present's

## खेळ बुद्धीचा खेळ शक्तीचा



Reg Fee:- 400 Rs / Team

Open To All Colleges

# KABADDI TOURNAMENT

from 10<sup>th</sup> to 12<sup>th</sup> Jan, 2019

**BEST RAIDER  
TROPHY**  
**BEST DEFENDER  
TROPHY**

Staff Co-ordinator

Prof. Tanzeem: 9370156886

Prof. Balaji Dadas: 9665234421

Student Co-ordinators

Kaivalya Kawli: 8419981531

Adwait Mirkar: 7208399398

Jignesh Patil: 8976425121

Scan For Registration



Sponsored By:



PRINCIPAL

THEEM COLLEGE OF ENGINEERING

Village Bettgaon, Boiser Chithar Road

Dist. Palghar - 407 501

## JSW Steel Coated Products Pvt. Ltd.





Thakur Educational Trust's (Regd.)  
**THAKUR INSTITUTE OF MANAGEMENT STUDIES,  
CAREER DEVELOPMENT & RESEARCH**

(Approved by AICTE, Govt. of Maharashtra & Affiliated to University of Mumbai)  
ISO 9001 : 2015 Certified



# Certificate

*This is to certify that Mr./Ms. Kunal Patil  
has stood 2nd for the event Cricket  
conducted during Vista 2019.*

**Prof. Shirshendu Maitra**  
Faculty Incharge  
THEEM COLLEGE OF ENGINEERING  
Village Betegaon, Boisar Chithar Road  
Boisar (East) Tal. & Dist. Palohar - 40

PRINCIPAL



**Dr. Vidya Gaiwad**  
Director, TIMSCDR



*Thakur Educational Trust's (Regd.)*  
**THAKUR INSTITUTE OF MANAGEMENT STUDIES,  
CAREER DEVELOPMENT & RESEARCH**



(Approved by AICTE, Govt. of Maharashtra & Affiliated to University of Mumbai)  
ISO 9001 : 2015 Certified

# Certificate

*This is to certify that Mr./Ms. Sagar Gaikwad  
has stood 2nd for the event Cricket  
conducted during Vista 2019.*

**Prof. Shirshendu Narra**  
Faculty Incharge

**PRINCIPAL**

**THEEM COLLEGE OF ENGINEERING**  
Village Betegaon, Borsar Chitthar Road,  
Palsar (East) Tal. & Dist. Palghar - 401305



**Dr. Vinita Gaikwad**  
Director, TIMSCDR





Thakur Educational Trust's (Regd.)  
**THAKUR INSTITUTE OF MANAGEMENT STUDIES,  
CAREER DEVELOPMENT & RESEARCH**



(Approved by AICTE, Govt. of Maharashtra & Affiliated to University of Mumbai)  
ISO 9001 : 2015 Certified

## Certificate

This is to certify that Mr./Ms. Dhanraj Naik  
has stood 2nd for the event Cricket  
conducted during Vista 2019.

**Prof. Shirshendu Maitra**  
Faculty Incharge

**PRINCIPAL**  
THEEM COLLEGE OF ENGINEERING  
At. Village Betegaon, Boisar Chithar Road  
Boisar (East) Tal. & Dist. Palghar - 42

  
**Dr. Vinita Gaikwad**  
Director, TIMSCDR



Thakur Educational Trust's (Regd.)  
**THAKUR INSTITUTE OF MANAGEMENT STUDIES,  
CAREER DEVELOPMENT & RESEARCH**



(Approved by AICTE, Govt. of Maharashtra & Affiliated to University of Mumbai)  
ISO 9001 : 2015 Certified

## Certificate

This is to certify that Mr./Ms. Krupesh Shinde  
has stood 2nd for the event Cricket  
conducted during Vista 2019.

VISTA

  
Prof. Shirshendu Maitra  
Faculty Incharge



**PRINCIPAL**  
THEM COLLEGE OF ENGINEERING  
At. Village Betegaon, Boisar Chilhar Road,  
Boisar (East) Tal. & Dist. Palghar - 407 505



  
Dr. Vinita Gaikwad  
Director, TIMSCDR



Thakur Educational Trust's (Regd.)  
**THAKUR INSTITUTE OF MANAGEMENT STUDIES,  
CAREER DEVELOPMENT & RESEARCH**

(Approved by AICTE, Govt. of Maharashtra & Affiliated to University of Mumbai)  
ISO 9001 : 2015 Certified



# Certificate

This is to certify that Mr./Ms. Harshad Pagdhare  
has stood 2nd for the event Cricket  
conducted during Vista 2019.

**Prof. Shirshendu Maitra**  
Faculty Incharge

**PRINCIPAL**

**THEEM COLLEGE OF ENGINEERING**  
At. Village Betegaon, Borsar Chilhar Road,  
Borsar (East) Tal. & Dist. Palghar - 401301



**Dr. Vidya Gaikwad**  
Director, TIMSCDR





HJ Thim Trust's

# Theem College of Engineering

Boisar Chilhar Road, Boisar (E), Tal. Palghar, Dist - Thane,  
Phone: (02525) 284909 / 284910 www.theemcoe.org

Ref. No.: TCE/EST/2018-19/253

Date: 16/10/18

To,  
The Principal,  
Viva Institute of Technology, *Vivekanand*

**Sub: - Invitation for Cricket Tournament "Theem Udaan Series"2018**

Sir,

We are organizing 2 day Cricket Tournament "Theem Udaan Series" From 19<sup>th</sup> Oct 2018 & 20<sup>th</sup> Oct 2018. We are going to have this event on season ball on inter college level. We feel that it's our honor to invite you to take active participation in it. Having good relation with student of various institutions is always beneficial to the institute and students. Keeping that in mind, We want the students from different institute to put their ideas forward. We hope this inter college event will create a platform for the talented youth.

We expect that you will encourage us with your active participation and make the event a grand success.

We look forward for positive response.

Warm regards,

(Dr. N.K.Rana)  
Principal



PRINCIPAL  
THEEM COLLEGE OF ENGINEERING  
At: Village Betagan, Boisar Chilhar Road,  
Boisar (East) Tal. & Dist. Palghar - 401 201



HJ Thim Trust's

# Theem College of Engineering

Boisar Chilhar Road, Boisar (E), Tal. Palghar, Dist - Thane.  
Phone: (02525) 284909 / 284910 www.theemcoe.org

Ref. No.: TCE/EST/2018-19/235

Date: 11/10/2018

To,  
The Manager,  
Dmart,  
Boisar

**Subject: Request & Invitation for 3 day Cricket Tournament from 19<sup>th</sup> Oct to 21<sup>st</sup> Oct 2018.**

Dear Sir,

Theem College of Engineering is organizing Cricket Tournament from 13<sup>th</sup> Oct to 15<sup>th</sup> Oct 2018. With reference to meeting with Mr. Abhijeet, it was decided that we need to attach net on the boundary walls of Dmart for safety of Customers. So please allow us to attach net on Dmart compound wall. And We are requesting you to close the parking in the passage near Theem boundary wall for 3 days.

**You are invited as a guest in this program for inauguration & prize distribution on the same date.**

We will be honored for your kind consent of accepting our invitation.

Thanking you,

Yours faithfully,

**Dr. N.K. Rana**  
Principal

THEEM COLLEGE OF ENGINEERING  
Boisar (East) Tal. & Dist. Palghar - 401 501.



PRINCIPAL

THEEM COLLEGE OF ENGINEERING  
At. Village Biregaon, Boisar (East) Tal. & Dist. Palghar - 401 501.





H. J. THIM TRUST'S

# THEEM COLLEGE OF ENGINEERING

Approved By AICTE (New Delhi), Government of Maharashtra & DTE, Affiliated To University of Mumbai & MSBTE. Estd. 2009

Present's

## खेळ बुद्धीचा खेळ शक्तीचा



Reg Fee:- 400 Rs / Team  
Open To All Colleges

## KABADDI TOURNAMENT

from 10<sup>th</sup> to 12<sup>th</sup> Jan, 2019

BEST RAIDER  
TROPHY

BEST DEFENDER  
TROPHY

**Staff Co-ordinator**  
Prof. Tanzeem: 9370156886  
Prof. Balaji Dadas: 9665234421  
**Student Co-ordinators**  
Kaivalya Kawli: 8419981531  
Adwait Mirkar: 7208399398  
Jignesh Patil: 8976425121

Scan For Registration



Sponsored By:



### JSW Steel Coated Products Pvt. Ltd.





H. J. THIM TRUST'S

# KABADDI TOURNAMENT

## THEEM COLLEGE OF ENGINEERING

Approved By AICTE (New Delhi), Government of Maharashtra & DTE, Affiliated To University of Mumbai & MSBTE. Estd. 2009

Present's

खेळ बुद्धीचा खेळ शक्तीचा



Rs. 5000  
Trophy  
Certificate  
1<sup>st</sup>

Rs. 3000  
Trophy  
Certificate  
2<sup>nd</sup>

### KABADDI TOURNAMENT

Register Before 10am of 10<sup>th</sup> Jan, 2019

Reg Fee: 400 Rs / Team  
Open To All College

Register Before 10am of 10<sup>th</sup>  
**BEST RAIDER TROPHY**  
**BEST DEFENDER TROPHY**

Sponsored By:

**Staff Co-ordinator**  
Prof. Tanzeem: 9370156886  
  
**Student Co-ordinators**  
Kaivalya Kawli: 8419981531  
Adwait Mirkar: 7208399398  
Aayush Vaity: 8888514733

**PRINCIPAL**  
THEEM COLLEGE OF ENGINEERING  
Village Betegaon, Bohar Chikhar Road,  
Palohar (East) Tal. & Dist. Palohar - 431 004.





H. J. Thim Trust's

# THEEM COLLEGE OF ENGINEERING

## NOTICE

Date: 16/8/2018

All students are hereby informed that who are interested for participating in **Kabaddi event** at university level, selection Trials will be on Tuesday i.e **21<sup>st</sup> August 2018 at 1:10pm** sharp on College ground.

**(NOTE: Be Present with entire kit)**

Prof. Syed Tanzeem  
Sports Coordinator

Dr. N.K.Rana  
Principal

Prof. Balaji Dadas  
Kabaddi Event Incharge



PRINCIPAL  
THEEM COLLEGE OF ENGINEERING  
At Village Betegaon, Boisar Chikhar Road  
Boisar (East) Tal. & Dist. Palghar



## **RULES & REGULATIONS FOR KABADDI**

All international rules will be followed except:-

- 1) There will be Weight Criteria ( Players Weight Limit is Under 85 Kg).
- 2) Umpire decision will be final without any argument.
- 3) If any misbehavior/fight Occurred during the match then that team will be disqualified.
- 4) Third Raid will be Do or Die Raid.
- 5) All out will be given 2 points.
- 6) 1 match will be of 14 minutes ,One round will be of 7 minutes.
- 7) In Case of Draw ,Extra 3 minutes will be included in match time.
- 8) Match is on ground ,no need of shoes.
- 9) In one match only 3 players can be substituted.
- 10) One strategic time out(break) per team in one match.

### **NOTE:**

- I. **ENTRY FEE FOR IS RS. 400 PER TEAM**
- II. **COLLEGE ID CARD AND SPORTS (STAFF) COORDINATOR ARE COMPULSORY.**



A handwritten signature in black ink, appearing to be "S. S. S.", written over a faint grid.

**PRINCIPAL**  
THEEM COLLEGE OF ENGINEERING  
At Village Betsapao, Bohar Chikhar, Boisar (East), Tal. & Dist. Palanpur - 385 001





Success... through  
quality education

H. J. Theem Trust's

# Theem College of Engineering

Approved by AICTE (New Delhi), Government of Maharashtra and DTE  
Affiliated to University of Mumbai

Village Betegaon, Boisar Chilhar Road, Boisar (E), Tal. & Dist. Palghar - 401 501  
Tel. (02525) 284 909 ● Telefax : (02525) 284 927 ● Email : info@theemcoe.org ● Website : www.theemcoe.org

Ref : TCE/EST/2018-19/398

Date : 2/1/2019

To,

The Principal,

\_\_\_\_\_  
\_\_\_\_\_

## **Sub : - Invitation for Kabaddi Tournament "Khel Budhicha Khel Shakticha"2019**

Sir,

We are organizing 3 day Kabaddi Tournament "Khel Budhicha Khel Shakticha" From 10<sup>th</sup> Jan 2019 to 12<sup>th</sup> Jan 2019. We are going to have this event on college ground on inter college level. We feel that it's our honor to invite you to take active participation in it.

Having good relation with student of various institutions is always beneficial to the institute and students. Keeping that in mind, We want the students from different institute to put their ideas forward. We hope this inter college event will create a platform for the talented youth.

We expect that you will encourage us with your active participation and make the event a grand success.

We look forward for positive response.

Warm regards,

(Dr. N.K.Rana)  
Principal



PRINCIPAL  
THEEM COLLEGE OF ENGINEERING  
Village Betegaon, Boisar Chilhar Road,  
Boisar (East) Tal. & Dist. Palghar - 401 501

PRINCIPAL  
THEEM COLLEGE OF ENGINEERING  
Boisar (East), Tal. & Dist. Palghar-401 501.



H. J. THIM TRUST'S  
**THEEM COLLEGE OF ENGINEERING, BOISAR**  
Approved By AICTE ( New Delhi) Government of Maharashtra & DTI  
Affiliated To University Of Mumbai

Village Betegaon, Near Union Park, Boisar Chihar Road, Boisar (E), Tal.-Dist.-Palghar, 401501. Tel: - (02525) 284909 / 284926.

Ref. No: TCR /EST /2018-19/346

Date: 18/12/18

To,

Respected Sir,

H.J.Thim Trust was established in the year 1982 with the laudable objective of Providing opportunity of Higher Education to the students. The trust is also known for their Philanthropic Contribution in the noble cause of education to downtrodden students. The Trust has taken a step ahead and established THEEM COLLEGE OF ENGINEERING at Tarapur, Boisar (East) with the different courses from Academic Year 2009.

Theem college of Engineering shall be holding the **Inter Collegiate Kabaddi Event** named a "Khel Budhicha Khel Shakkicha" to develop the extra Curricular activity of the students during 10<sup>th</sup> to 12<sup>th</sup> January 2019. In this Event number of students are expected from other Engineering Commerce, Arts and Science colleges.

You can help by sponsoring any event through advertisements, banners & prize etc.  
You can also help us by giving financial aid either recurring or one time or donating prize money named in loving memory of your dear annually for excellence in sports activities.

- 1) **Banner** - Size 5X3, 3X6 & 10X6
- 2) **Stalls** - Size 6X8 to showcase your established for 3 days

Payment should be accepted by **Account Payee Cheque** only in favour of "**Theem Engineering Students Fund**"

We look upon support from the privileged member of the society to donate generously & help a good cause.

Thanking You,  
Regards

Syed Tanzeem  
Sports In-charge  
Mob: 9370156886

PRINCIPAL  
THEEM COLLEGE OF ENGINEERING  
Village Betegaon, Boisar Chihar R.  
Boisar (East) Tal. & Dist. Palghar



Dr. N.K.Rana  
Principal  
PRINCIPAL  
THEEM COLLEGE OF ENGINEERING  
Boisar (East), Tal. & Dist. Palghar-401 501



H. J. THIM TRUST'S  
**THEEM COLLEGE OF ENGINEERING, BOISAR**  
Approved By AICTE ( New Delhi) Government of Maharashtra & DTI  
Affiliated To University Of Mumbai

Village Betegaon, Near Union Park, Boisar Chilhar Road, Boisar (E), Tal.-Dist.-Palghar, 401501. Tel: - (02525) 284909 / 284926,

**Banners**

Sr.No.	Category	Size	No.of Banners	Amount of Sponsorship (Rs)
1.	Gate boundary	5X3	2	10,000/-
2.	Entrance Sideways	3X6	2	8,000/-
3.	Sliders	10X6	1	10,000/-
4.	Bus	5X3	1	5,000/-

**Event Sponsorship** – You can sponsor complete event. We will do full advertisement of your organization by our anchors & banners in throughout event. We will allow your banner at ground fence during event days.



  
**PRINCIPAL**  
**THEEM COLLEGE OF ENGINEERING**  
Boisar (East), Tal. & Dist. Palghar-401 501.



**PRINCIPAL**  
THEEM COLLEGE OF ENGINEERING  
At Village Betegaon, Boisar Chilhar Road,  
Boisar (East) Tal. & Dist. Palghar-401 501.



**UNIVERSITY OF MUMBAI**  
 मुंबई विद्यापीठ  
**ELEGIBILITY PROFORMA FOR INTER - COLLEGIATE Kabaddi TOURNAMENTS 2018-2019**  
 अंतर महाविद्यालयीन स्पर्धेचे पात्रता प्रपत्र 2018-2019

Sr.No. क्र.सं.	Name of the Competitors (In full beginning with Surname)				Detail information of players		स्पर्धकांचा तपशील							
	Surname उपनाम	First Name पहिले नाव	Father's Name वडीलचे नाव	Mother's Name आईचे नाव	Date of Birth जन्मदिनांक	Month & Year of Passing H.S.C./Equivalent Examination 12 वी किंवा तत्सम परीक्षा उत्तीर्ण महिना व वर्ष	Write Month & year of first admission to College महाविद्यालयगाते प्रथम प्रवेश घेतलेले महिना	Write Month & year of first admission to present course प्रास्तुत प्रथम प्रवेश घेतलेले महिना	Write Month & year of first admission to present class सध्याचा वर्ग प्रवेश घेतलेले महिना	mention Present class with Roll No. सध्याचा वर्ग व हजेरी क्रमांक	No. of years participated in Inter Collegiate Tournament आ. म. स्पर्धांमध्ये किती वेळा भाग घेतला	Whether Employed (Say Yes or No) केवळी काम आहे का? (होय/ना)	Player's Sign on * declaration	
							Exam. Month & Year	4a	4b	4c	5	6	7	8
1a	1b	1c	1d	2	3a	3b	4a	4b	4c	5	6	7	8	
1	Kani	Nikhil	Jagdish	Nirmala	2-11-1997			Aug-2017	Sep-2018	25	1	No		
2	Fati	Dignesh	Manoj	Minal	5-3-1997			Aug-2018	Sep-2018	25	2	No		
3	Mishra	Rajkumar	Gangaram	Mira	9-9-1998			Aug-2018	Sep-2018	17	2	No		
4	Fati	Shubham	Karan	Kamini	19-11-1999			Aug-2018	Aug-2018	30	1	No		
5	Kani	Nikhil	Narash	Mani	28-05-1997			Aug-2014	Sep-2018	24	1	No		
6	Gupta	Rohit	Ramkish	Pinki	05-01-1997			Aug-2018	Aug-2018	20	1	No		
7	Mishra	Sudheer	Gulab	Sushila	01-12-1997			Aug-2017	Sep-2018	16	1	No		
8	Naitu	Payush	Vijay	Arushi	27-05-97			Aug-2018	Sep-2018	17	2	No		
9	Naitu	Payush	Vijay	Arushi	4-08-97			Aug-2018	Sep-2018	17	2	No		
10	Wadekar	Kesava	Manish	Megha	26-11-99			Aug-2018	Aug-2018	20	1	No		
11	Shukla	Abhishek	Santosh	Reshita	30-07-13			Aug-2018	Aug-2018	18	1	No		
12	Atharv	chetan	Narayan	Arushi	5-11-15			Aug-2018	Aug-2018	15	1	No		
13								Aug-2018	Sep-18	10	1	No		
14														
15														
16														

I certify that above entries are correct and the above mentioned competitors are bonafied students & are eligible to participate in the competition under the eligibility rules as at Fill in this column as under

- 4(a) State the month and year in which the student first joined in senior college affiliated to university immediately after passing H.S.C. or qualifying exam. Do not enter the name of the college enter year only
- 4 (b) State the month and year of first joining the present course viz arts.com.sci.etc. do not write name of the course.
- \*6 Declaration: I declare that I will be available for coaching camp and to participate in inter university Tournaments/competition, if selected in the current year failing which the University will be empowered to take suitable action against me.



**PRINCIPAL**  
**THEEM COLLEGE OF ENGINEERING**  
 At. Village Betegaon, Boisar Chikhar Road,  
 Boisar (East) Tal. & Dist. Palghar - 401 501



*(Signature)*  
 Principal  
 College Seal  
**PRINCIPAL**  
**THEEM COLLEGE OF ENGINEERING**  
 Boisar (East), Tal. & Dist. Palghar-401 501



UNIVERSITY OF MUMBAI INTER COLLEGIATE KABADDI  
TOURNAMENT 2018 - 2019



**ENTRY FORM FOR TEAM EVENT ONLY**

(To be submitted on or before the last date mentioned in the Sports Calendar.)

Name of the College & Code No.:  
THEEM COLLEGE OF ENGG., 3222  
Tel. No.: 02525-284909  
Fax No.: \_\_\_\_\_  
E-mail: tanzeem.syed@theemoe.org

The Director of Phy. Edun. & Sports,  
University of Mumbai,  
University Sports Pavilion,  
Marine Lines, Mumbai-400 020.

Sir,

I am please to inform you that my college will be participating in the KABADDI  
Tournament/s to be held during the current academic year. Our College has paid Annual Sports  
Contribution vide Cheque/DD.No. 015967 dated 21/18 and Entry Fees vide  
Cheque/DD.No. \_\_\_\_\_ dated \_\_\_\_\_ to the University. If Sports  
Contribution/Entry Fee not paid the entry may be rejected.

MEN /  WOMEN

Place: Boisar

Date: 1/8/18



PRINCIPAL  
PRINCIPAL

THEEM COLLEGE OF ENGINEERING  
Boisar (East), Tal. & Dist. Palghar-401 501  
(College Seal)

Note: PLEASE } Name SYED TANZEEM & Phone No. 9370156886 of any other  
STATE } responsible person from your College to contact him/her in case of emergency/  
HERE } urgency arises beyond normal working hours or on holidays.

PRINCIPAL  
THEEM COLLEGE OF ENGINEERING  
St. Village Biringan, Boisar Chhtr R.  
Boisar (East) Tal. & Dist. Palghar



UNIVERSITY OF MUMBAI



(SPORTS DEPARTMENT)

ENTRY FORM FOR TEAM EVENT ONLY

INTER COLLEGIATE KABADDI TOURNAMENT, 2013-2014  
(To be submitted on or before the last date mentioned in the Sports Calendar.)

Name of the College & Code No. :

THEEM COLLEGE OF ENGG., 3222

Tel. No. : 02525-284903

Fax No. : \_\_\_\_\_

e-mail : sys-admin@theemcoe.org

To,  
The Director of Phy. Edun. & Sports,  
University of Mumbai,  
University Sports Pavilion,  
Marine Lines, Mumbai-400 020.

Sir,

This is to inform you that THEEM COLLEGE OF ENGG. College will

be participating in the Inter-Collegiate KABADDI Tournament for

MEN/WOMEN

To be held during the current academic year. The list of players is enclosed herewith/will be sent later. Our college has paid annual Sports Contribution/Entry Fee Vide Cheque/DB No. 291148, Dated 29/11/13, respectively to the University. If Sports Contribution/Entry Fee not paid the entry may be rejected.

Yours faithfully,

PRINCIPAL  
PRINCIPAL

THEEM COLLEGE OF ENGINEERING  
Boisar (Eas), Tal. & Dist. Palghar-401 501

(College Seal)

Place: BOISAR

Date: 16/3/2013



PLEASE STATE HERE } Phone Number 9370156886 & Name : SYED TANZEEM  
of any other responsible person from your college to contact him/her in case of emergency/urgency arises beyond normal working hours or on holidays.

PRINCIPAL  
THEEM COLLEGE OF ENGINEERING  
Village Betejan, Boisar Tal. & Dist. Palghar  
Boisar (Eas), Tal. & Dist. Palghar





Success... through  
quality education!

# Theem College of Engineering

Village Betegaon, Boisar Chillar Road, Boisar (E), Tal. & Dist. Palghar - 401 501.

Tel.: (02525) 284 909 • Telefax : (02525) 284 927 • Email : info@theemcoe.org • Website : www.theemcoe.org

TCE/ECY/2018-19/329

Page: 07/12/18

To,  
The Director,  
Students welfare Department,  
V. V. Bhavan, 'B' Churchgate,  
Mumbai 20.

**Sub :- Submission of Students Inter university sports & Cultural Activities  
Fees Academic Year 2018-2019.**

Dear Sir,

With reference to above Subject our THEEM COLLEGE OF ENGINEERING  
Established during academic year 2009-2010 having following Eight branches now:

- 1) Computer Engineering - (60)
- 2) Electronics Engineering - (60)
- 3) Information Technology - (60)
- 4) Electronics & Tele communication Engineering - (60)
- 5) Mechanical Engineering - (120)
- 6) Civil Engineering - (60)
- 7) Electrical Engineering - (60)
- 8) Auto-Mobile Engineering - (60)

We have to pay Students Inter university sports & Cultural Activities Fees @ Rupees 24 per students of our college. We have enrolled 1004 students (Regular SE, TE & BE) during academic year 2018-2019 and the fee of Cultural Activities Rupees 24,096/- ( Twenty Four Thousand Ninty Six Only) payable in favour of 'Finance and Accounts Officer University of Mumbai' by Cheque number - 291148 Dated - 29/11/2018 Samata Sahkari Bank Limited, Oshiwara, Mumbai is enclosed.

Kindly acknowledge.

Thanking You,

Yours Faithfully,

(Dr. N. K. Rana)  
Principal



Head Office : 310, Yusuf Building, Veer Nariman Road, Fort, Mumbai - 400 023.

Tel.: 2204 6903 • Telefax : 2283 9850

VALID FOR THREE MONTHS

29/11/2018  
D D M M Y Y Y Y

समता सहकारी बँक लिमिटेड  
SAMATA SAHAKARI BANK LIMITED  
717718 ADARSH NAGAR, OSHIWARAMUMBAI-400 102  
IFSC CODE : SRC30SAM01

Finance & Accounts officer University of Mumbai या धारक को Or Bearer

अदा करे। ₹ 24,096/-  
Twenty four thousand ninety six only

A/c.No 004200100002092

pay to a/c only



*Arav*  
Theem College of Engineering  
(Please sign above)

105580037 041195

10



*[Signature]*

PRINCIPAL  
THEEM COLLEGE OF ENGINEERING  
At Village Botegaon, Botter Chitthor Road  
Boisar (East) Tal. & Dist. Palanhar



(SPORTS DEPARTMENT)

ENTRY FORM FOR TEAM EVENT ONLY

INTER COLLEGIATE FOOTBALL TOURNAMENT, 2019 - 2020  
(To be submitted on or before the last date mentioned in the Sports Calendar.)

Name of the College & Code No.:

THEEM COLLEGE OF ENGG., 3222

Tel. No.: 02525-284309

Fax No.: \_\_\_\_\_

e-mail: sys-admin@theemcoe.org

To,  
The Director of Phy. Edu. & Sports,  
University of Mumbai,  
University Sports Pavilion,  
Marine Lines, Mumbai-400 020.

Sir,

This is to inform you that THEEM COLLEGE OF ENGG, College will

be participating in the Inter-Collegiate FOOTBALL Tournament for

(MEN & WOMEN)  
MEN/WOMEN

To be held during the current academic year. The list of players is enclosed herewith/will be sent later. Our college has paid annual Sports Contribution/Entry Fee Vide Cheque/DD No. 291148, Dated 29/11/18, respectively to the University. If Sports Contribution/Entry Fee not paid the entry may be rejected.

Place: MUMBAI BOISSAR

Date: 16/9/2019



Yours faithfully,

PRINCIPAL  
PRINCIPAL

THEEM COLLEGE OF ENGINEERING  
Boissar (East), Tel. & Dist. Palghar-401 501.

(College Seal)

PLEASE STATE HERE } Phone Number 9370156486 & Name: SYED TANZEEM  
of any other responsible person from your college to contact him/her in case of emergency/  
urgency arises beyond normal working hours or on holidays.

PRINCIPAL  
THEEM COLLEGE OF ENGINEERING  
Sr. Village Boissar, Bassein Taluka & Dist. Palghar-401 501.





Success... through  
quality education!

# Theem College of Engineering

Village Betegaon, Boisar Chihar Road, Boisar (E), Tal. & Dist. Palghar - 401 501.  
Tel.: (02525) 284 909 ● Telefax : (02525) 284 927 ● Email : info@theemcoe.org ● Website : www.theemcoe.org

TCE/Est/2018-19/329

Date: 07/12/18

To,  
The Director,  
Students welfare Department,  
V. V. Bhavan, 'B' Churchgate,  
Mumbai 20.

**Sub :- Submission of Students Inter university sports & Cultural Activities  
Fees Academic Year 2018-2019.**

Dear Sir,

With reference to above Subject our THEEM COLLEGE OF ENGINEERING  
Established during academic year 2009-2010 having following Eight branches now:

- 1) Computer Engineering - (60)
- 2) Electronics Engineering - (60)
- 3) Information Technology - (60)
- 4) Electronics & Tele communication Engineering - (60)
- 5) Mechanical Engineering - (120)
- 6) Civil Engineering - (60)
- 7) Electrical Engineering - (60)
- 8) Auto-Mobile Engineering - (60)

We have to pay Students Inter university sports & Cultural Activities Fees @ Rupees  
24 per students of our college. We have enrolled 1004 students (Regular SE, TE & BE)  
during academic year 2018-2019 and the fee of Cultural Activities Rupees 24,096/- (Twenty  
Four Thousand Ninty Six Only) payable in favour of 'Finance and Accounts Officer  
University of Mumbai' by Cheque number - 291148 Dated - 29/11/2018 Samata Sahkari  
Bank Limited, Oshiwara, Mumbai is enclosed.

Kindly acknowledge.

Thanking You,

PRINCIPAL  
THEEM COLLEGE OF ENGINEERING  
Village Betegaon, Boisar Chihar Road,  
Boisar (East), Tal. & Dist. Palghar



Yours Faithfully,

(Dr. N. K. Rana)  
Principal

समता सहकारी बँक लिमिटेड  
SAMATA SAHAKARI BANK LIMITED  
717/718 ADARSH NAGAR, OSHIVARAMI, MUMBAI-400 102  
IFSC CODE - SRCB0SAMCO1

VALID FOR THREE MONTHS

29 11 2018  
D D M M Y Y Y Y

Finance & Accounts Officer University of Mumbai

या शाखे को Or Branch

Twenty four thousand ninety six only

अंश करे।

₹ 24,096/-

A/c No

004200100003092

Payd A/c only



*Away*

Theem College of Engineering

(Please sign above)

१०२९११४०११ ४०००६०३५०१

10



*[Signature]*

PRINCIPAL

THEEM COLLEGE OF ENGINEERING

M. Village Betegaon, Boisar Chimer Road,  
Boisar (East) Tal. & Dist. Palghar.

# KABADDI TOURNAMENT 2019

## ENTRY FORM

10<sup>th</sup> Jan-12<sup>th</sup> Jan

# KABADDI TOURNAMENT 2019

## ENTRY FORM

10<sup>th</sup> Jan-12<sup>th</sup> Jan

NAME OF THE COLLEGE:- Raja Dahanu  
 ENGG. or TECHNICAL / ARTS or Commerce:-  
 CAPTAIN'S NAME:- Harshad Patil

CONTACT NO:- 46 8600198293

Sr.No.	Students Full name	Branch/Year	Signature
1	Abhishek B. Patil	1 <sup>st</sup> year	[Signature]
2	Harshad Patil	=11=	[Signature]
3	Harshad H. Patil	=11=	[Signature]
4	Charandeep Pujari	=11=	[Signature]
5	Mojanesh V. More	1 <sup>st</sup> year	[Signature]
6	Prathamash Patil	2 <sup>nd</sup> year	[Signature]
7	Senkesh Dubale	1 <sup>st</sup> year	[Signature]
8	Kaushik Tendulkar	1 <sup>st</sup> year	[Signature]
9	Rohit Pitmane	1 <sup>st</sup> year	[Signature]
10			
11			
12			[Signature]
13			PRINCIPAL THEEM COLLEGE OF ENGINEERING M. Village Betgaon, Borser Chikho P. Boisar (East) Tal. & Dist. Palghar - 401
14			
15			
16			



Note:- Without I.D. card students shall not be allowed to participate in the event

Coordinator Sign



10<sup>th</sup> Jan-12<sup>th</sup> Jan

400/- Paid.

# KABADDI TOURNAMENT 2019

## ENTRY FORM

10<sup>th</sup> Jan-12<sup>th</sup> Jan

NAME OF THE COLLEGE:- JES (Jogeshwari Education Society) Commerce  
ENGG. or TECHNICAL / ARTS or Commerce:-  
CAPTAIN'S NAME:- Hrishikesh Ghag

CONTACT NO:- 8169416437  
8454085710

Sr.No.	Students Full name	Branch/Year	Signature
1	Hrishikesh Ghag	Com	<i>[Signature]</i>
2	Omkar Patil	Com	<i>[Signature]</i>
3	Sandesh Nair	Com	<i>[Signature]</i>
4	Subodh Narkar	Com	<i>[Signature]</i>
5	Rahul Hindlekar (Datta)	Com	<i>[Signature]</i>
6	Pratik Padwal	Com	<i>[Signature]</i>
7	Shreyas Surve	Com	<i>[Signature]</i>
8	Omkar nakashe	Com	<i>[Signature]</i>
9	Biddhesh Gawde	F.Y.BMS	<i>[Signature]</i>
10			
11			
12			<i>[Signature]</i>
13			<b>PRINCIPAL</b> THEEM COLLEGE OF ENGINEERING At Village Betegaon, Boisar Chitambar Boisar (East) Tal. & Dist. Palahar - 17
14			
15			
16			



Note:- Without I.D. card students shall not be allowed to participate in the event

Coordinator Sign  
Principal Sign 1004









NAME OF THE COLLEGE:-

ENGG. or TECHNICAL / ARTS or Commerce:-

Katohara polytechnic, Bardi

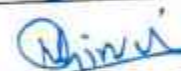
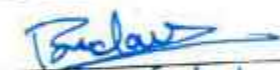
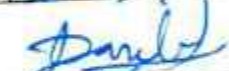
CAPTAIN'S NAME:- Nimish. S Raut

CONTACT NO:- 9665334043

Sr.No.	Students Full name	Branch/Year	Signature
1	Nimish S Raut	CE TY	
2	Kunjan Raut	MET Y	
3	Sankalp R. Dhanmcher.	ME FY	
4	Mushahid M. Shaikh	EE SY	
5	Manendav. T. Gahalod	EE SY	
6	Himanshu. R. Bari	CO SY	
7	Rohit. B. Mandave	ME FY	
8	Darpan S. Tandel	ME. SY	
9	Abhiraj Bhandari	ME TY	
10	Pravin. P. Sane.	EE SY	
11			
12			
13			PRINCIPAL
14			THEEN COLLEGE OF ENGINEERING At. Village Belgaon, Borsar Chitthar Borsar (East) Tal. & Dist. Palohar - 47
15			
16			

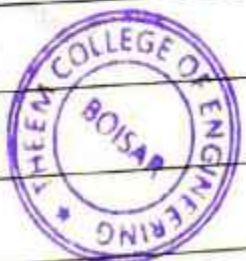

Note:- Without I.D. card students shall not be allowed to participate in the event



# KABADDI TOURNAMENT 2019

## ENTRY FORM

10<sup>th</sup> Jan-12<sup>th</sup> Jan

NAME OF THE COLLEGE:- St. John's  
 ENGG. or TECHNICAL / ARTS or Commerce:-  
 CAPTAIN'S NAME:-

CONTACT NO:-

Sr.No.	Students Full name	Branch/Year	Signature
1	Shani Singh	Mechanical	Shani
2	Sachin Yadav	Computer	Sachin
3	Vinay Soni	Mechanical	Soni
4	Roshan. Grawde	Computer	Roshan
5	Anuj. Rane	I.T	Anuj Rane
6	Saurabh. Shukla.	I.T	Saurabh
7	Ankit. Mishra.	I.T	Ankit
8	Vivek. Soni.	Mechanical	Vivek
9	Bhavik. Tamore.	Mechanical	Bhavik
10	Harshik prasad	mechanical	Harshik
11	Kaustubh Bari	Mechanical	Kaustubh
12	Deveshi tandel	mech	Deveshi
13	Khan Kamalabbas Granior Rehman	B.Sc (Hs)	Khan
14			
15			
16			



Note:- Without I.D card students shall not be allowed to participate in the event

Coordinator Sign

PRINCIPAL

THEEM COLLEGE OF ENGINEERING  
 St. Village Betegaon, Boisar Chilhara P.  
 Boisar (East) Tal. & Dist. Palahar, Jharkhand



10<sup>th</sup> Jan-12<sup>th</sup> Jan**KABADDI TOURNAMENT 2019****ENTRY FORM**10<sup>th</sup> Jan-12<sup>th</sup> JanNAME OF THE COLLEGE:- *M.K. Jr. College*

ENGG. or TECHNICAL / ARTS or Commerce:-

CAPTAIN'S NAME:- *Sumit. N. Shelke*

CONTACT NO:-

Sr.No.	Students Full name	Branch/Year	Signature
1	<i>Sumit. N. Shelke</i>	<i>Arts (XII)</i>	<i>Sumit</i>
2	<i>Ramesh. V. Bari</i>	<i>Com. (XII)</i>	<i>Ramesh</i>
3	<i>Aakash. B. Bairagi</i>	<i>Arts (XI)</i>	<i>Aakash</i>
4	<i>Kaushik. N. Chaudhari</i>	<i>Com. (XI)</i>	<i>Kaushik</i>
5	<i>Aman. D. Jadhav</i>	<i>Com. (XI)</i>	<i>Aman</i>
6	<i>Chandan. C. Yadav</i>	<i>Com. (XI)</i>	<i>Chandan</i>
7	<i>Khemnath. M. Suryavanshi</i>	<i>Com. (XI)</i>	<i>Khemnath</i>
8	<i>Abhishek. R. Patil</i>	<i>Com. (XI)</i>	<i>Abhishek</i>
9	<i>Paras. D. Bari</i>	<i>Com. (XII)</i>	<i>Paras</i>
10	<i>Faraag. N. Damanwala</i>	<i>Com. (XI)</i>	<i>Faraag</i>
11	<i>Papil. R. Chauhan</i>	<i>Com. (XI)</i>	<i>Papil</i>
12	<i>Rajesh. M. Pillai</i>	<i>Arts (XI)</i>	<i>Rajesh</i>
13	<i>Rohan. J. Rajbhar</i>	<i>Arts (XI)</i>	<i>Rohan</i>
14			<i>[Signature]</i>
15			
16			



PRINCIPAL  
THE M. K. J. COLLEGE OF ENGINEERING  
At Village Bhatgaon, Boisar Taluka -  
BOISAR (E.M), TAL & DIST. PACHGUAJI

Note:- Without I.D. card students shall not be allowed to participate in the event

Principal Sign

10<sup>th</sup> Jan-12<sup>th</sup> Jan

# KABADDI TOURNAMENT 2019

## ENTRY FORM

NAME OF THE COLLEGE:- N.B Mehta Science and College, Bardi  
ENGG. or TECHNICAL / ARTS or Commerce:-  
CAPTAIN'S NAME:- Keval P. Majvelkar

10<sup>th</sup> Jan-12<sup>th</sup> Jan

CONTACT NO:- 8390269748

Sr.No.	Students Full name	Branch/Year	Signature
1	Keval P. Majvelkar	PC	
2	Tanmay S. Dharne	C	
3	Shreyas R. Chaudhari	Bcom	Shreyas
4	Sahil Y. Save	IT	S.Y. Save
5	Mounish D. Patil	IT	Mouil
6	Mehul H. Bhanushali	Bcom	Mehul
7	Sanket S. Kolhe	PC	Sanket
8	Dawane Sachin G.	IT	S.G.
9	Dawane Hamesh S.	IT	H.S.
10	Shiva S. Khengar	IT	Shengar
11			
12			
13			
14			
15			
16			



PRINCIPAL  
THE M. COLLEGE OF ENGINEERING  
St. Village Belegaon, Bolisar Chitambar  
Palhar (East) Tal. & Dist. Palhar

Note:- Without I.D. card students shall not be allowed to participate in the event

Coordinator Sign



10<sup>th</sup> Jan-12<sup>th</sup> Jan

THEEM ENGG (C)

# KABADDI TOURNAMENT 2019

## ENTRY FORM

10<sup>th</sup> Jan-12<sup>th</sup> Jan

NAME OF THE COLLEGE:- Ideal

ENGG. or TECHNICAL / ARTS or Commerce:-

CAPTAIN'S NAME:- Nishank - Vartak

CONTACT NO:-

Sr.No.	Students Full name	Branch/Year	Signature
1	Nishank Vartak.		<u>N.P. Vartak</u>
2	Adarsh. Singh		<u>Adarsh</u>
3	Samay. Pimple		<u>Samay</u>
4	Aniket Sankhe		<u>Aniket</u>
5	Rohan Mali		<u>Rohani</u>
6	Sanket Dhadve		<u>Sanket</u>
7	Mayuresh Kharpude		<u>Mayuresh</u>
8	Shreyash V. Ujgaonkar		<u>Shreyash</u>
9	Gaurav Satvi		
10			
11			
12			<u>[Signature]</u>
13			PRINCIPAL
14			THEEM COLLEGE OF ENGINEERING
15			Village-Betegaon, Boisar Chitthar P.
16			Boisar (East) Tal. & Dist. Palahar - 41



Note:- Without I.D. card students shall not be allowed to participate in the event

Coordinator Sign



10<sup>th</sup> Jan-12  
 NAME OF THE COLLEGE:- THEEM ENGG (C)  
 ENGG. or TECHNICAL / ARTS or Commerce:- FRIGG

# KABADDI TOURNAMENT 2019

## ENTRY FORM

10<sup>th</sup> Jan-12<sup>th</sup> Jan

NAME OF THE COLLEGE:- Theem College of Engineering  
 ENGG. or TECHNICAL / ARTS or Commerce:-  
 CAPTAIN'S NAME:- Jignesh Patil

CONTACT NO:-

Sr.No.	Students Full name	Branch/Year	Signature
1	Jignesh Patil	B.E ME	
2	Rahul Gupta	SE CE	
3	Nikhil Keri	TE EE	
4	Niket Kini	BE EE	
5	Shubham Patil	SE EE	
6	Suraj Sawant	SE Auto	
7	Sudhir Gupta	SE CO	
8	Sharikh Khan		
9	<del>Arunach</del>		
10	Piyush Patil		
11	Manish Manzari		
12	Suraj Gawad		<b>PRINCIPAL</b> THEEM COLLEGE OF ENGINEERING At. Village Belegaon, Boisar Chikher R. Boisar (East) Tal. & Dist. Palohar.
13			
14			
15			
16			



Note:- Without I.D. card students shall not be allowed to participate in the event

Coordinator Sign

# KABADDI TOURNAMENT 2019

## ENTRY FORM

10<sup>th</sup> Jan-12<sup>th</sup> Jan

NAME OF THE COLLEGE:-

ENGG. or TECHNICAL / ARTS or Commerce:-

CAPTAIN'S NAME:- Swapnil Nalwade CONTACT NO:-

Sr.No.	Students Full name	Branch/Year	Signature
1	Kaivalya Kauli		
2	Swapnil Nalwade		
3	Vinay Pathak		
4	chetan Patil		
5	Abhishek Shukla		
6	Armit Wajinganekar		
7	Adwait Mirdekar		
8	Dhiraj Koti		
9	Chandrapaksh Pandya		
10	Krushang		
11	Chinmay Patre.		
12			
13			PRINCIPAL THEEM COLLEGE OF ENGINEERING At Village-Betegaon, Boisar, Chitaval Boisar (East) Tal. & Dist. Palghar - 40
14			
15			
16			



Note:- Without I.D. card students shall not be allowed to participate in the event

Coordinator Sign

# KABADDI TOURNAMENT 2019

## ENTRY FORM

10<sup>th</sup> Jan-12<sup>th</sup> Jan

NAME OF THE COLLEGE:- THEEM ENGG (C)  
 ENGG. or TECHNICAL / ARTS or Commerce:- ENGG  
 CAPTAIN'S NAME:- AAYUSH VAITY

CONTACT NO:-

Sr.No.	Students Full name	Branch/Year	Signature
1	- AAYUSH VAITY	Ty (ME)	
2	- NINAYAK PATONKAR	Ty (ME)	
3	- Chandra Prakash Pandey	Sy (ME)	
4	- Chinmay Patre	Sy (ME)	
5	- Sachin Apte	Ty (ME)	
6	- Faiz Monchale	Ty (CO)	
7	- Pankaj Patil	Ty (ME)	
8	- Chetan Patil	Ty (BE)	
9	- Jishesh Patil	BE (Auto)	
10			
11			
12			
13			
14			
15			
16			

Note:- Without I.D. card students shall not be allowed to participate in the event

Coordinator Sign

THEEM COLLEGE OF ENGINEERING, BOISAR		PRINCIPAL THEEM COLLEGE OF ENGINEERING At Village Betegaon, Boisar Chithar Road Boisar (East) Tal. & Dist. Palghar - 40
_____ TEAM		
BRANCH:-		YEAR:-
CLASS:-		
CAPTAIN'S NAME:-		
Amount Received:-		
		(Student Coordinator)



# KABADDI TOURNAMENT 2019

## ENTRY FORM

10<sup>th</sup> Jan-12<sup>th</sup> Jan

NAME OF THE COLLEGE:- THEEM ENGG (C)

ENGG. or TECHNICAL / ARTS or Commerce:- ENGG

CAPTAIN'S NAME:- AAYUSH VAITY

CONTACT NO:- 888514733

Sr.No.	Students Full name	Branch/Year	Signature
1	AAYUSH VAITY	TJ (ME)	A
2	Zulfikar Shaikh	TJ (ME)	S
3	Chetan Patil	BE (ME)	C/P
4	Vinayak Patankar	TJ (ME)	V/Pan
5	Sarvesh Rupaye	TJ (ME)	Kalafar
6	Chandrabhush Pandey	SJ (ME)	R
7	Chinmay Patne	SJ (ME)	A
8	Mohammed Raza	SJ (COM)	A
9	<del>Krushank Datre</del>		
10	Swaphil Apte	TJ (ME)	Pankaj
11	Sohil Bari	TJ (ME)	Namrata Somvale
12	Kaushal Pamarli	TJ (ME)	Deeba
13	Faiz	TJ (CO)	A
14	Pankaj Patil	TJ (ME)	Raj
15	Dharam Ghesat	TJ (ME)	A
16			

Note:- Without I.D. card students shall not be allowed to participate in the event

Coordinator Sign



THEEM COLLEGE OF ENGINEERING, BOISAR

TEAM

YEAR:-

BRANCH:-

CLASS:-

CAPTAIN'S NAME:-

Amount Received:-



(Student Coordinator)

PRINCIPAL  
THEEM COLLEGE OF ENGINEERING  
At Village Betogao, Boisar Taluk, Dist. Palghar

# Kabaddi

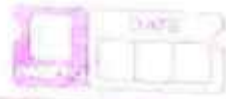

- 1] Rajkumar Mishra 3 - IT-TE *(Rajkumar)* 9730796592
- 2] Nikhil Keni <sup>8</sup> - TE-EE *(Nikhil)* 7767048102
- 3] Jignesh Patil <sup>3</sup> ~~(Patil)~~ - BE-Auto *(Jignesh)* 8976425121
- 4] Adwait Mirkar <sup>16</sup> - BE-Auto *(Adwait)* 7208399398
- 5] Shubham Patil <sup>12</sup> ~~(Patil)~~ - SE-EE *(Shubham)* 7263817321
- 6] Aayush Vaity <sup>7</sup> - TY-ME *(Aayush)* 8888514733
- 7] Rahul Gupta <sup>9</sup> ~~(Gupta)~~ - SE-CE *(Rahul)* 8888115930
- 8] Abhishek Shakla <sup>10</sup> ~~(Shakla)~~ - SY-ME *(Abhishek)* 8169559827
- 9] Kairalya Kawli <sup>9</sup> - TY-ME *(Kairalya)* 8419981531
- 10] Swapnil Nalawade <sup>6</sup> - TY-ME *(Swapnil)* 8451967303
- 11] Niket Kini <sup>10</sup> ~~(Kini)~~ - BE-EE *(Niket)* 7276298465

org

PRINCIPAL  
THEEM COLLEGE OF ENGINEERING  
Village Betegeon, Boisar Chikar  
Dist. Palghar - 40



UNIVERSITY OF MUMBAI INTER COLLEGIATE KABADDI  
TOURNAMENT 2018 - 2019



**ENTRY FORM FOR TEAM EVENT ONLY**

(To be submitted on or before the last date mentioned in the Sports Calendar.)

Name of the College & Code No.:

THEEM COLLEGE OF ENGG., 3222

Tel. No.: 02525-284909

Fax No.: \_\_\_\_\_

E-mail: tanzeem.syed@theemcoe.org

The Director of Phy. Edu. & Sports,  
University of Mumbai,  
University Sports Pavilion,  
Marine Lines, Mumbai-400 020.

Sir,

I am please to inform you that my college will be participating in the KABADDI  
Tournament/s to be held during the current academic year. Our College has paid Annual Sports  
Contribution vide Cheque/DD.No. 915967 dated 2/1/18 and Entry Fees vide  
Cheque/DD.No. \_\_\_\_\_ dated \_\_\_\_\_ to the University. If Sports  
Contribution/Entry Fee not paid the entry may be rejected.

MEN /  WOMEN

Place: Boisar

Date: 4/8/18



**PRINCIPAL**  
**THEEM COLLEGE OF ENGINEERING**  
Boisar (East), Tal. & Dist. Palghar-401 501.  
(College Seal)

**Note: PLEASE** Name SYED TANZEEM & Phone No. 9370156886 of any other  
**STATE** } responsible person from your College to contact him/her in case of emergency/  
**HERE** } urgency arises beyond normal working hours or on holidays.

**PRINCIPAL**  
**THEEM COLLEGE OF ENGINEERING**  
14 Village Bhegaon, Boisar Tal. & Dist. Palghar - 401 501.  
Boisar (East) Tal. & Dist. Palghar - 401 501.







समता सहकारी बँक लिमिटेड  
**SAMATA SAHAKARI BANK LIMITED**  
 717718, ADARSH NAGAR, OSHIWARAMUMBAI-400 102  
 IFSC CODE : SRCB0SAM001

VALID FOR THREE MONTHS

0 2 0 1 2 0 1 8  
 D D M M Y Y Y Y

AT, CONTACTS, 2018  
 Clearing Agent: The Mumbai DCC Bank Ltd.

Pay Finance & Accounts officer University of Mumbai वा धारक को Or-Bearer

Rupees रुपये Twenty five thousand eight hundred seventy two only  
 अदा करे | ₹ | 25,872/-

A/c.No | 004200100003092



*Ama*  
 THEEM COLLEGE OF ENGINEERING  
 (Please sign above)

⑈015967⑈ 400068350⑈ 003092⑈ 10



*[Signature]*

PRINCIPAL  
 THEEM COLLEGE OF ENGINEERING  
 St. Village Beteagan, Boisar Chikhar R...  
 Boisar (East) Tal. & Dist. Palghar - 40

## Kabaddi Squad 2018-19

- 1) Rajkumar Mishra - II-TE
- 2) Nilchil Keni - EE-TE
- 3) Jignesh Patil - BE-Auto
- 4) Adwait Mirkar - BE-Auto
- 5) Shubham Patil - SE-~~Auto~~ EE
- \*6) Ayush Vaity - TY-~~EE~~ ME
- 7) Rahul Gupta - SE-CE
- \*8) Abhishek Shukla - SY-ME
- \*9) Kairaly Kawali - TY-ME
- \*10) Swapnil Nalawade - TY-ME
- 11) Niket Kini - BE-CE
- 12) Sudhir Gupta - SE-Camp



PRINCIPAL  
THEEM COLLEGE OF ENGINEERING  
St. Vinayk Bldg, Boisar, Dist. Palghar  
Palghar (East) Tal. & Dist. Palghar

UNIVERSITY OF MUMBAI INTER COLLEGIATE KHO-KHO  
TOURNAMENT 2018 - 2019



**ENTRY FORM FOR TEAM EVENT ONLY**

(To be submitted on or before the last date mentioned in the Sports Calendar.)

Name of the College & Code No.:  
THEEM COLLEGE OF ENGG., 3222  
Tel. No.: 02525-284909  
Fax No.: \_\_\_\_\_  
E-mail: tanzeem.syed@theemcoe.org

The Director of Phy. Edun. & Sports,  
University of Mumbai,  
University Sports Pavilion,  
Marine Lines, Mumbai-400 020.

Sir,

I am please to inform you that my college will be participating in the KHO-KHO  
Tournament/s to be held during the current academic year. Our College has paid Annual Sports  
Contribution vide Cheque/DD.No. 015967 dated 2/1/18 and Entry Fees vide  
Cheque/DD.No. \_\_\_\_\_ dated \_\_\_\_\_ to the University. If Sports  
Contribution/Entry Fee not paid the entry may be rejected.

MEN /  WOMEN

Place: Boisar

Date: 2/8/18



  
PRINCIPAL  
THEEM COLLEGE OF ENGINEERING  
Boisar (Eas.), Tal. & Dist. Palghar-401 501  
(College Seal)

Note: PLEASE STATE HERE } Name SYED TANZEEM & Phone No. 9370156886 of any other  
} responsible person from your College to contact him/her in case of emergency/  
} urgency arises beyond normal working hours or on holidays.

PRINCIPAL  
THEEM COLLEGE OF ENGINEERING  
M. Village Boteagan, Boisar Chitra B.  
Boisar (Eas.) Tal. & Dist. Palghar - 401 501







समता सहकारी बँक लिमिटेड  
**SAMATA SAHAKARI BANK LIMITED**  
 717718, ADARSH NAGAR, OSHIWARAMUMBAI-400 102  
 IFSC CODE : SRCB0SAM001

VALID FOR THREE MONTHS

0 2 0 1 2 0 1 8  
 D D M M Y Y Y Y

या धारक को Gr-Bearer

Pay Finance & Accounts officer University of Mumbai

Rupees रुपये Twenty five thousand Eight hundred Seventy

two only

अदा कर

₹ 25,872/-

A/c.No 004200100003092



*[Signature]*  
 THEEM COLLEGE OF ENGINEERING  
 (Please sign above)

⑈015967⑈ 400068350⑈ 003092⑈ 10



*[Signature]*

PRINCIPAL  
 THEEM COLLEGE OF ENGINEERING  
 At Village Belegaon, Boisar Chitler Dist.  
 Boisar (East) Tal. & Dist. Palghar - 40

UNIVERSITY OF MUMBAI INTER COLLEGIATE KHO-KHO  
TOURNAMENT 2018 - 2019



**ENTRY FORM FOR TEAM EVENT ONLY**

(To be submitted on or before the last date mentioned in the Sports Calendar.)

Name of the College & Code No.:  
THEEM COLLEGE OF ENGG., 3222  
Tel. No.: 02525-284909  
Fax No.: \_\_\_\_\_  
E-mail: tanzeem.syed@theemcoe.org

The Director of Phy. Edun. & Sports,  
University of Mumbai,  
University Sports Pavilion,  
Marine Lines, Mumbai-400 020.

Sir,

I am please to inform you that my college will be participating in the KHO-KHO  
Tournament/s to be held during the current academic year. Our College has paid Annual Sports  
Contribution vide Cheque/DD.No. 015967 dated 2/11/18 and Entry Fees vide  
Cheque/DD.No. \_\_\_\_\_ dated \_\_\_\_\_ to the University. If Sports  
Contribution/Entry Fee not paid the entry may be rejected.

MEN /  WOMEN

Place: Boisar

Date: 2/8/18



  
PRINCIPAL  
PRINCIPAL  
THEEM COLLEGE OF ENGINEERING  
Boisar (Eas.), Tal. & Dist. Palghar-401 501  
(College Seal)

Note: PLEASE } Name SYED TANZEEM & Phone No. 9370156886 of any other  
STATE } responsible person from your College to contact him/her in case of emergency/  
HERE } urgency arises beyond normal working hours or on holidays.



PRINCIPAL  
THEEM COLLEGE OF ENGINEERING  
At Village Britegao, Boisar Tal. & Dist. Palghar-401 501





समता सहकारी बँक लिमिटेड  
**SAMATA SAHAKARI BANK LIMITED**  
 717/718 ADARSH NAGAR, OSHIWARAMUMBAI-400 102  
 IFSC CODE : SRCB0SAM001

VALID FOR THREE MONTHS

0 2 0 1 2 0 1 8  
 D D M M Y Y Y Y

Pay Finance & Accounts officer University of Mumbai या धारक को Gr-Bearer

Rupees रुपये Twenty five thousand Eight hundred seventy two only

अदा करें ₹ 25,872/-

A/c.No 004200100003092



*[Signature]*  
 THEEM COLLEGE OF ENGINEERING  
 (Please sign above)

⑈015967⑈ 400068350⑈ 003092⑈ 10



*[Signature]*  
 PRINCIPAL  
 THEEM COLLEGE OF ENGINEERING  
 At Village Betegaon, Boisar Chitler R-1  
 Boisar (East) Tal. & Dist. Palghar. (M)





H. J. Thim Trust's

# THEEM COLLEGE OF ENGINEERING

## NOTICE

Date: 25/9/2018

All students are hereby informed that who are interested for participating in **Cricket** event at Inter Collegiate level & university level, selection Trials will be on Wednesday i.e. **27<sup>th</sup> September 2018 at 05:10pm** sharp on College ground.  
**(Note: Bring your Own Kit)**

Prof. Syed Tanzeem  
Sports Coordinator

Dr. N.K.Rana  
Principal

Prof. Rakesh Khuswah  
Cricket Event Incharge



  
PRINCIPAL  
THEEM COLLEGE OF ENGINEERING  
Village Betgaon, Borsar Chittranilaya  
Boisar (East) Tal. & Dist. Palghar



Thakur Educational Trust's (Regd.)

# THAKUR INSTITUTE OF MANAGEMENT STUDIES, CAREER DEVELOPMENT & RESEARCH



(Approved by AICTE, Govt. of Maharashtra & Affiliated to University of Mumbai)  
ISO 9001 : 2015 Certified

## Certificate

This is to certify that Mr./Ms. Sachin Pathak  
has stood 2nd for the event Cricket  
conducted during Vista 2019.



**Prof. Shirshendu Maitra**  
Faculty Incharge

**PRINCIPAL**  
THEEM COLLEGE OF ENGINEERING  
At Village Betegaon, Boisar Chilhara  
Boisar (East) Tal. & Dist. Palohar - 40



**Dr. Vinita Gaikwad**  
Director, TIMSCDR



Thakur Educational Trust's (Regd.)

# THAKUR INSTITUTE OF MANAGEMENT STUDIES, CAREER DEVELOPMENT & RESEARCH



(Approved by AICTE, Govt. of Maharashtra & Affiliated to University of Mumbai)  
ISO 9001 : 2015 Certified

## Certificate

This is to certify that Mr./Ms. Sachin Pathak  
has stood 2nd for the event Cricket  
conducted during Vista 2019.



**Prof. Shirshendu Maitra**  
Faculty Incharge

**PRINCIPAL**  
THEEN COLLEGE OF ENGINEERING  
At Village-Betegaon, Boisar, Chithar, Ra.  
Boisar (East) Tal. & Dist. Palohar - 40

**Dr. Vinita Gaikwad**  
Director, TIMSCDR







Thakur Educational Trust's (Regd.)

# THAKUR INSTITUTE OF MANAGEMENT STUDIES, CAREER DEVELOPMENT & RESEARCH



(Approved by AICTE, Govt. of Maharashtra & Affiliated to University of Mumbai)  
ISO 9001 : 2015 Certified

## Certificate

This is to certify that Mr./Ms. Prajal Bore  
has stood 2nd for the event Cricket  
conducted during Vista 2019.



**Prof. Shirshendu Maitra**  
Faculty Incharge



**PRINCIPAL**  
THEEM COLLEGE OF ENGINEERING  
Village Betegaon, Borsar Chilhara Road  
Borsar (East) Tal. & Dist. Palahar - 482 001

**Dr. Vinita Gaikwad**  
Director, TIMSCDR



Thakur Educational Trust's (Regd.)  
**THAKUR INSTITUTE OF MANAGEMENT STUDIES,  
CAREER DEVELOPMENT & RESEARCH**



(Approved by AICTE, Govt. of Maharashtra & Affiliated to University of Mumbai)  
ISO 9001 : 2015 Certified

## Certificate

This is to certify that Mr./Ms. Prachit Rout  
has stood 2nd for the event Cricket  
conducted during Vista 2019.

# VISTA

**Prof. Shirshendu Maitra**  
Faculty Incharge

**Dr. Vinita Gaikwad**  
Director, TIMSCDR

**PRINCIPAL**  
THEEM COLLEGE OF ENGINEERING  
At. Village Betegaon, Borsar Chilhara Road,  
Borsar (East) Tal. & Dist. Panchajanya - 751001





**RAHUL GROUP OF SCHOOLS AND COLLEGES**  
(SHREE L.R. TIWARI COLLEGE OF ENGINEERING, MIRA ROAD)

**CERTIFICATE**  
**OF HONOUR**

This certificate is proudly presented to  
Mr./M/s. MARSHAD PAUDHARE of THEEM COLLEGE  
has been awarded the RUNNER UP in the event  
of CRICKET (OPEN) conducted on 6<sup>th</sup> FEB'19

PRINCIPAL  
THEEM COLLEGE OF ENGINEERING  
Village Betegaon, Tal. Chitambar,  
Dist. Thane (East) Tal. & Dist. Thane

1027

10<sup>th</sup> FEB'19  
DATE



Jayaram B. B. B.  
FOUNDER CHAIRMAN



# CERTIFICATE OF HONOUR

This certificate is proudly presented to  
Mr./Ms. PRAYOT AREKAR of THEEM COLLEGE  
has been awarded the RUNNER UP in the event  
of CRICKET (OPEN) conducted on 6<sup>th</sup> FEB'19

10<sup>th</sup> FEB'19

DATE



Jasleen Bhatnagar

FOUNDER CHAIRMAN

PRINCIPAL

# CERTIFICATE OF HONOUR

This certificate is proudly presented to  
Mr./Ms. NISCHAL DAWANE of THEEM COLLEGE  
has been awarded the RUNNER UP in the event  
of CRICKET (OPEN) conducted on 6<sup>th</sup> FEB' 19

**PRINCIPAL**  
THEEM COLLEGE OF ENGINEERING  
At Village Boisar, Boisar, Chikhar Road,  
Boisar (East) Tal. Boisar, Dist. Palghar - 401 301

DATE



  
FOUNDER CHAIRMAN



# CERTIFICATE OF HONOUR

This certificate is proudly presented to  
Mr./M/s. KRUPESH SHINDE of THEEM COLLEGE  
has been awarded the RUNNER UP in the event  
of CRICKET (OPEN) conducted on 6<sup>th</sup> FEB'19



**PRINCIPAL**

THEEM COLLEGE OF ENGINEERING  
At. Village: Brijgaon, Bolser Chithar Road,  
Bolser (Dist. Ch.) & Dist. Palghar - 401 201

10<sup>th</sup> FEB'19

DATE



FOUNDER CHAIRMAN



# CERTIFICATE OF HONOUR

This certificate is proudly presented to

Mr./Ms. PRAJAL BORE of THEEM COLLEGE  
has been awarded the RUNNER UP in the event  
of CRICKET (OPEN) conducted on 6<sup>th</sup> FEB' 19



PRINCIPAL

THEEM COLLEGE OF ENGINEERING

Village Betegaon, Borsar Chitthar Road,  
Borsar (East) Tal. & Dist. Palohar - 41

DATE



FOUNDER CHAIRMAN

# CERTIFICATE OF HONOUR

This certificate is proudly presented to  
Mr./Ms. KAUSTUBH VINDE of THEEM COLLEGE  
has been awarded the RUNNER UP in the event  
of CRICKET (OPEN) conducted on 6<sup>th</sup> FEB'19



PRINCIPAL  
THEEM COLLEGE OF ENGINEERING  
At Village Biregaon, Boisar Chikhar  
Boisar (East) Tal. & Dist. Palohar - 42

DATE



FOUNDER CHAIRMAN



# CERTIFICATE OF HONOUR

This certificate is proudly presented to  
Mr./Ms. SAGAR PAWAR of THEEM COLLEGE  
has been awarded the RUNNER UP in the event  
of CRICKET (OPEN) conducted on 6<sup>th</sup> FEB'19



PRINCIPAL

THEEM COLLEGE OF ENGINEERING  
Village Betegaon, Boisar Chitambar  
(First Tal. & Dist. Palghar - 40

6<sup>th</sup> FEB'19

DATE



FOUNDER CHAIRMAN



# CERTIFICATE OF HONOUR

This certificate is proudly presented to  
Mr./Ms. KARAN SHETTY of THEEM COLLEGE  
has been awarded the RUNNER UP in the event  
of CRICKET (OPEN) conducted on 6<sup>th</sup> FEB' 19



PRINCIPAL  
THEEM COLLEGE OF ENGINEERING  
At Village Brijgaon, Bolisar Chitkar R-  
Dolisar (E.H). Tal. & Dist. Palahar - M

DATE



FOUNDER CHAIRMAN

# CERTIFICATE OF HONOUR

This certificate is proudly presented to

Mr./Ms. KUNAL PATIL of THEEM COLLEGE  
has been awarded the RUNNER UP in the event  
of CRICKET (OPEN) conducted on 6th FEB' 19



PRINCIPAL

THEEM COLLEGE OF ENGINEERING  
At. Village Betegaon, Boisar Chithar Road,  
Boisar (East) Tal. & Dist. Palohar - 41

DATE



FOUNDER CHAIRMAN



*Thakur Educational Trust's (Regd.)*  
**THAKUR INSTITUTE OF MANAGEMENT STUDIES,  
 CAREER DEVELOPMENT & RESEARCH**



(Approved by AICTE, Govt. of Maharashtra & Affiliated to University of Mumbai)  
 ISO 9001 : 2015 Certified

# Certificate

*This is to certify that Mr./Ms. Prachit Rout  
 has stood 2nd for the event Cricket  
 conducted during Vista 2019.*

VISTA

**Prof. Shirshendu Maitra**  
 Faculty Incharge



**PRINCIPAL**  
**THEEM COLLEGE OF ENGINEERING**  
 Village Betegaon, Boisar Chithar Road,  
 Boisar (East) Tal. & Dist. Palghar - 401 501

**Dr. Vinita Gaikwad**  
 Director, TIMSCDR





Thakur Educational Trusts (Regd.)

# THAKUR INSTITUTE OF MANAGEMENT STUDIES, CAREER DEVELOPMENT & RESEARCH



(Approved by AICTE, Govt. of Maharashtra & Affiliated to University of Mumbai)  
ISO 9001 : 2015 Certified

## Certificate

This is to certify that Mr./Ms. Prajal Bore  
has stood 2nd for the event Cricket  
conducted during Vista 2019.

**Prof. Shirshendu Maitra** PRINCIPAL  
Faculty Incharge  
THEM COLLEGE OF ENGINEERING  
At Village Betegaon, Borsar Chilkhar Road  
Borsar (East)-Tal. & Dist. Palahar - 481 103



**Dr. Vinita Gaikwad**  
Director, TIMSCDR



*Thakur Educational Trust's (Regd.)*  
**THAKUR INSTITUTE OF MANAGEMENT STUDIES,  
CAREER DEVELOPMENT & RESEARCH**



(Approved by AICTE, Govt. of Maharashtra & Affiliated to University of Mumbai)  
ISO 9001 : 2015 Certified

# Certificate

*This is to certify that Mr./Ms. Sachin Pathak  
has stood 2nd for the event Cricket  
conducted during Vista 2019.*

VISTA

**Prof. Shirshendu Maitra**  
Faculty Incharge

**PRINCIPAL**

**THEEM COLLEGE OF ENGINEERING**  
At. Village Betegaon, Boisar Chilhar Road,  
Boisar (East) Tal. & Dist. Palghar - 40



**Dr. Vinita Gaikwad**  
Director, TIMSCDR



Thakur Educational Trust's (Regd.)

# THAKUR INSTITUTE OF MANAGEMENT STUDIES, CAREER DEVELOPMENT & RESEARCH



(Approved by AICTE, Govt. of Maharashtra & Affiliated to University of Mumbai)  
ISO 9001 : 2015 Certified

## Certificate

This is to certify that Mr./Ms. Kunal Patil  
has stood 2nd for the event Cricket  
conducted during Vista 2019.

VISTA

**Prof. Shirshendu Maitra**  
Faculty Incharge

**PRINCIPAL**

**THEEM COLLEGE OF ENGINEERING**  
At Village Betegaon, Boisar Chitthar Road,  
Boisar (East) Tal. & Dist. Palghar - 401 301



**Dr. Vinata Gaikwad**  
Director, TIMSCDR





Thakur Educational Trust's (Regd.)

# THAKUR INSTITUTE OF MANAGEMENT STUDIES, CAREER DEVELOPMENT & RESEARCH



(Approved by AICTE, Govt. of Maharashtra & Affiliated to University of Mumbai)  
ISO 9001 : 2015 Certified

## Certificate

This is to certify that Mr./Ms. Sagar Gaikwad  
has stood 2nd for the event Cricket  
conducted during Vista 2019.

VISTA

**Prof. Shirshendu Maitra**  
Faculty Incharge **PRINCIPAL**  
THEEM COLLEGE OF ENGINEERING  
At. Village Betegaon, Botsar Chikhar Road  
Botsar (East)-Tal. & Dist. Palghar - 40



**Dr. Vinita Gaikwad**  
Director, TIMSCDR



*Thakur Educational Trust's (Regd.)*  
**THAKUR INSTITUTE OF MANAGEMENT STUDIES,  
 CAREER DEVELOPMENT & RESEARCH**

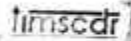

(Approved by AICTE, Govt. of Maharashtra & Affiliated to University of Mumbai)  
 ISO 9001 : 2015 Certified

# Certificate

*This is to certify that Mr./Ms. Harshad Pagdhare  
 has stood 2nd for the event Cricket  
 conducted during Vista 2019.*



*Signature of Prof. Shirshendu Maitra*

*Signature of Dr. Vinna Gaikwad*

**Prof. Shirshendu Maitra** PRINCIPAL  
 Faculty Incharge  
 GREEN COLLEGE OF ENGINEERING  
 At Village Betegaon, Boisar Chithar Road  
 Boisar (East), Tal. & Dist. Palanhar - 40



**Dr. Vinna Gaikwad**  
 Director, TIMSCDR



Thakur Educational Trust's (Regd.)

**THAKUR INSTITUTE OF MANAGEMENT STUDIES,  
CAREER DEVELOPMENT & RESEARCH**



(Approved by AICTE, Govt. of Maharashtra & Affiliated to University of Mumbai)  
ISO 9001 : 2015 Certified

## Certificate

This is to certify that Mr./Ms. Krupesh Shinde  
has stood 2nd for the event Cricket  
conducted during Vista 2019.

**Prof. Shirshendu Maitra** PRINCIPAL  
Faculty Incharge  
GREEN COLLEGE OF ENGINEERING  
At. Village Betegaon, Boisar Chithar Rd.  
Boisar (East) Tal. & Dist. Palohar - 40



**Dr. Vinita Gaikwad**  
Director, TIMSCDR





*Thakur Educational Trusts (Regd.)*  
**THAKUR INSTITUTE OF MANAGEMENT STUDIES,  
CAREER DEVELOPMENT & RESEARCH**

timscdr

(Approved by AICTE, Govt. of Maharashtra & Affiliated to University of Mumbai)  
ISO 9001 - 2015 Certified

## Certificate

*This is to certify that Mr./Ms. Dhanraj Naik  
has stood 2nd for the event Cricket  
conducted during Vista 2019.*

  
**Prof. Shirshendu Maitra**  
Faculty Incharge

  
**PRINCIPAL**

**THEEM COLLEGE OF ENGINEERING**  
At Village Betegaon, Boisar Chithar Road,  
Boisar (East) Tal. & Dist. Palohar - 425 301



  
**Dr. Vinita Gaikwad**  
Director, TIMSCDR

# CERTIFICATE OF HONOUR

This certificate is proudly presented to  
Mr./M/s. KRUPESH SHINDE of THEEM COLLEGE  
has been awarded the RUNNER UP in the event  
of CRICKET (OPEN) conducted on 6<sup>th</sup> FEB'19



PRINCIPAL

THEEM COLLEGE OF ENGINEERING  
At Village: Shivajinagar, Boisar, Chithar Road,  
Boisar (Dist: Thane) Taluka: Palnhar.

10<sup>th</sup> FEB'19

DATE

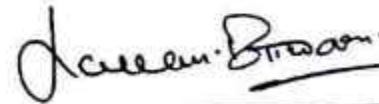

FOUNDER CHAIRMAN



# CERTIFICATE OF HONOUR

This certificate is proudly presented to  
Mr./Ms. KAUSTUBH VINDE of THEEM COLLEGE  
has been awarded the RUNNER UP in the event  
of CRICKET (OPEN) conducted on 6<sup>th</sup> FEB '19



PRINCIPAL

THEEM COLLEGE OF ENGINEERING  
At Village Beraon, Boisar, Chithar Road,  
Boisar (East) Tal. Bha. Dist. Thane.

DATE



FOUNDER CHAIRMAN



# CERTIFICATE OF HONOUR

This certificate is proudly presented to  
Mr./Ms. PRASAL BORE of THEEM COLLEGE  
has been awarded the RUNNER UP in the event  
of CRICKET (OPEN) conducted on 6<sup>th</sup> FEB' 19



PRINCIPAL

THEEM COLLEGE OF ENGINEERING  
At Village Barambada, District Chitthar Road,  
Roisar (East) Tal. & Dist. Roisar

DATE

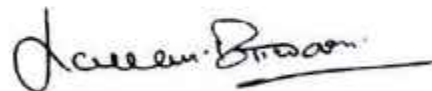

FOUNDER CHAIRMAN

# CERTIFICATE OF HONOUR

This certificate is proudly presented to  
Mr./M/s. SAGAR PAWAR of THEEM COLLEGE  
has been awarded the RUNNER UP in the event  
of CRICKET (OPEN) conducted on 6<sup>th</sup> FEB'19

10<sup>th</sup> FEB'19

DATE



Deepam Bhatnagar

FOUNDER CHAIRMAN



# CERTIFICATE OF HONOUR

This certificate is proudly presented to  
Mr./Ms. KARAN SHETTY of THEEM COLLEGE  
has been awarded the RUNNER UP in the event  
of CRICKET (OPEN) conducted on 6<sup>th</sup> FEB' 19



**PRINCIPAL**  
THEEM COLLEGE OF ENGINEERING  
At Village Boisar, Boisar, Chithar Road,  
Boisar (East), Tal. Boisar, Dist. Thane.

DATE



**FOUNDER CHAIRMAN**



# CERTIFICATE OF HONOUR

This certificate is proudly presented to  
Mr./Ms. PRACHIN RAUT of THEEM COLLEGE  
has been awarded the RUNNER UP in the event  
of CRICKET (OPEN) conducted on 6<sup>th</sup> FEB' 19

  
PRINCIPAL

10<sup>th</sup> FEB' 19  
DATE

THEEM COLLEGE OF ENGINEERING  
At Village: Bhoisan, Bhoisan Chitthar Road,  
Bhoisan, Taluka: Mira, Dist: Palghar - 401 305

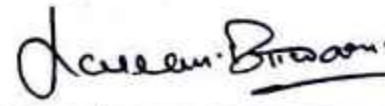

  
FOUNDER CHAIRMAN



# CERTIFICATE OF HONOUR

This certificate is proudly presented to  
Mr./Ms. KUNAL PATIL of THEEM COLLEGE  
has been awarded the RUNNER UP in the event  
of CRICKET (OPEN) conducted on 6th FEB'19



PRINCIPAL  
THEEM COLLEGE OF ENGINEERING  
27, Vinayaknagar, Boisar Chitkar Rd.  
Boisar Road, Palnhar - 41

DATE



FOUNDER CHAIRMAN



# CERTIFICATE OF HONOUR

This certificate is proudly presented to  
Mr./Ms. HARSHAD PAGOHARE of THEEM COLLEGE  
has been awarded the RUNNER UP in the event  
of CRICKET (OPEN) conducted on 6<sup>th</sup> FEB'19



PRINCIPAL

THEEM COLLEGE OF ENGINEERING  
Village: Mira Road, District: Mira  
MIRA ROAD, MIRA

10<sup>th</sup> FEB'19

DATE



FOUNDER CHAIRMAN





PRINCIPAL  
JEEENICOLLEGE OF ENGINEERING  
At Village Bellaspur, Borsar Chikhar  
Near East Tal. & Dist. Palanpur



10/01/2019 Cultral Day





PRINCIPAL  
THEEM COLLEGE OF ENGINEERING  
Village Behagan, Boisar Chhher  
Boisar (East) Tal. & Dist. Palanpur







14/01/2019 Certificate Distribution Jashn-e-theem





**PRINCIPAL**  
**THEEM COLLEGE OF ENGINEERING**  
At Village Betegaon, Borsar Chithar P.  
Borsar (East) Tal. & Dist. Patkhar -

Director sir addressing the students in Jashn-e-theem 14/01/2019





19/01/2019 Group Photo of participating students in Jashn-e-theem





14/01/2019 Certificate Distribution in Jashn-e-theem





14/01/2019 Certificate Distribution in Jashn-e-theem